

To:

**Light touch switch
and Detector switch
Product Introduction
for Smart Watch and Smart glass**

August 2025

Panasonic
INDUSTRY

**IN Your
Innovation**

Light touch switch for Smart watch and Smart glass

Light touch switch for Smart watch · Smart glass

Power button · Menu · Mode setting



EVPAE



4.5mmx2.2mm
h=2.9mm
Travel: 0.13mm, 0.15mm
Life: 200K cycles

IP67

EVPBB



2.6mmx1.6mm
h=0.5mm, 0.53mm,
h=0.55mm, 0.57mm
Travel: 0.08mm, 0.11mm
Life: 200K, 500K cycles

IP67

EVPAK



3.9mmx2.05mm
h=1.6mm
Travel: 0.12mm
Life: 500K cycles

IP67

EVPBL



2.8mmx1.9mm
h=0.53mm, 0.57mm, 0.6mm
Travel: 0.15mm
Life: 300K cycles

IP67

EVPAT



3.4mmx1.7mm
h=1.65mm
Travel: 0.08mm, 0.11mm
Life: 500K cycles

IP67

EVPAW



3.0mmx2.0mm
h=0.6mm
Travel: 0.13mm, 0.15mm
Life: 300K, 500K cycles

Power button · Menu · Mode setting



IP67

EVPBB



2.6mmx1.6mm
h=0.5mm, 0.53mm,
h=0.55mm, 0.57mm
Travel: 0.08mm, 0.11mm
Life: 200K, 500K cycles

IP67

EVPBL



2.8mmx1.9mm
h=0.53mm, 0.57mm, 0.6mm
Travel: 0.15mm
Life: 300K cycles

IP67

EVPAW



3.0mmx2.0mm
h=0.6mm
Travel: 0.13mm, 0.15mm
Life: 300K, 500K cycles

IP67

EVPAT



3.4mmx1.7mm
h=1.65mm
Travel: 0.08mm, 0.11mm
Life: 500K cycles

Needs trend for smart watch and the features of light touch switches

Compact size, good click feel, and high reliability such as dustproof, waterproof, and flux resistance

Smart watch

Power button • menu • mode setting



- ✓ Dustproof and waterproof
- ✓ Small-sized and thin-profile
- ✓ High Strength
- ✓ Good operability and click feel

Smart glass

Power button • menu • mode setting



- ✓ Dustproof and waterproof
- ✓ Small-sized and thin-profile
- ✓ Good operability and click feel
- ✓ Quiet operation

1. Dustproof, waterproof • flux resistant

- High dust resistance due to film-sealed structure.
- High waterproofness due to the sealing structure by laser welding.
- High flux resistance due to terminal surface treatment.

2. High strength • Design appeal





- High peel strength due to edge-mounted construction.
(substrate delamination)

3. Good operability • click feel • quiet operation

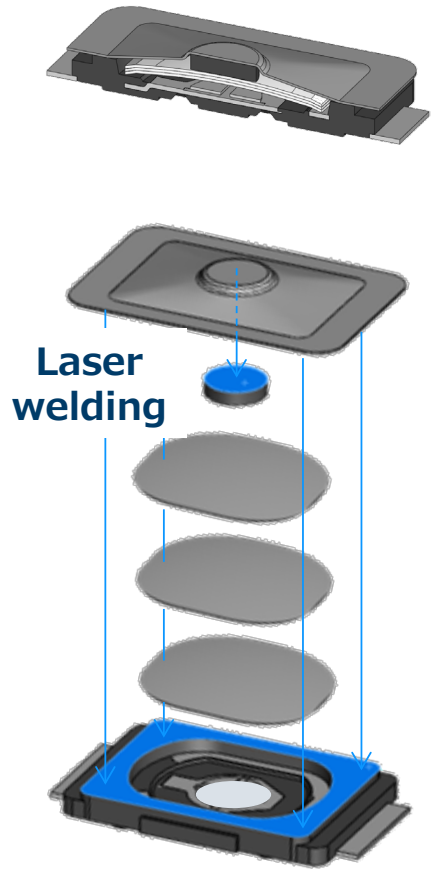
- Good operability and click feel due to the structure with push plate.
- Good operability and click feel due to the in-house metal dome.
- Control the operation sound while maintaining the click feel.

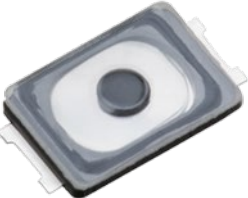
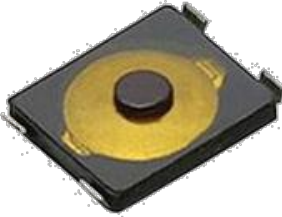
Laser welded push plate-film & film-molding case

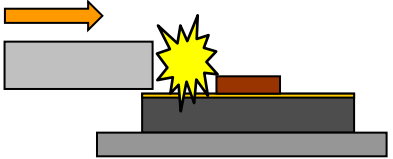

Feature	Laser welding	Film adhesive
Water-proof / Oil resistance		
Good click feeling	<p>Switch click feeling ≙ Metal dome click feeling</p> 	<p>Switch click feeling ≙ Metal dome click feeling + adhesive influence</p> <p>Adhesive</p> 
Easy assembling	<p>Inner actuator (The actuator is under the cover film)</p> 	<p>The actuator is sticking out on the surface</p> 

Improved waterproofing and flux ingress resistance to reduce defects during mounting

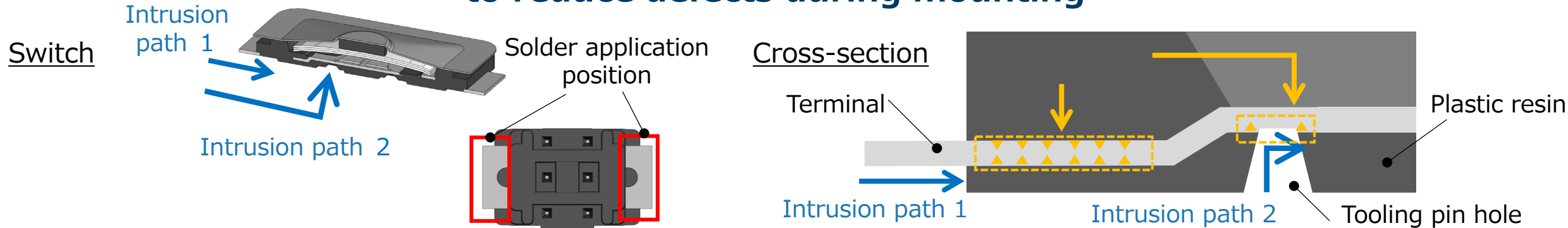

Effect of blast treatment

1. Strong adhesive between terminal & plastic resin

Higher adhesive by anchor effect.

2. Extended length of intrusion path

Longer path by rough surface.

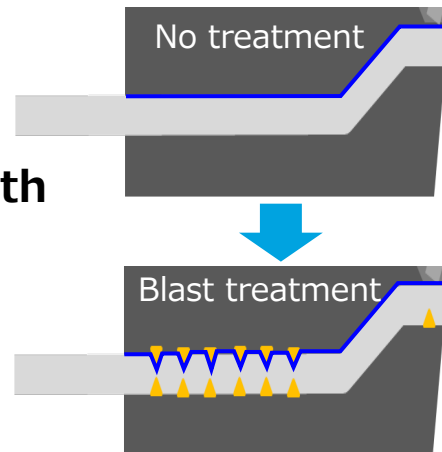

Products with blast treatment

3.0mm x 2.0 mm SMD LSW



2.8mm x 1.9 mm SMD LSW



2.6mm x 1.6 mm SMD LSW

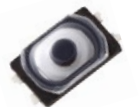

Dustproof, Water-proof, Flux resistant

Higher waterproof performance compared

IP67

Dustproof / Water-proofing	IP6x	IPx7	Resist-Flux /UF intrusion
Condition	<ul style="list-style-type: none"> Dust : Talc (Type 4) Density: 2kg/m³ Duration of test: 8h No switch push 	<ul style="list-style-type: none"> Test agent: Water Submerged depth: 1.0m Submerged time: 30 min. No switch push in water 	<ul style="list-style-type: none"> Solder paste: Indium 8.9HF Solder volume : 0.324mm³ ※4 x Panasonic recommendation UF coating : UF3808 Volume : 1.5 mg
Criteria	<ul style="list-style-type: none"> No dust ingress to the inside of switch 	<ul style="list-style-type: none"> Mechanical & Electrical characteristic met spec 	<ul style="list-style-type: none"> Flux intrusion UF intrusion
3.0mm x 2.0 mm SMD LTSW	OK	OK	OK
2.8mm x 1.9 mm SMD LTSW			
2.6mm x 1.6 mm SMD LTSW			

High dust resistance due to film-sealed structure

IP67
EVPBB



2.6mmx1.6mm
h=0.5mm, 0.53mm, 0.55mm, 0.57mm
Travel: 0.08mm, 0.11mm
Life: 200K, 500K cycles

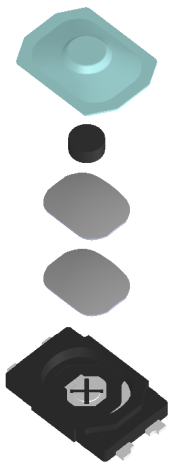

IP67
EVPBL



2.8mmx1.9mm
h=0.53mm, 0.57mm, 0.6mm
Travel: 0.15mm
Life: 300K cycles

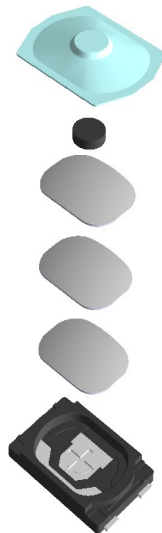

IP67
EVPBW



3.0mmx2.0mm
h=0.6mm
Travel: 0.13mm, 0.15mm
Life: 300K, 500K cycles

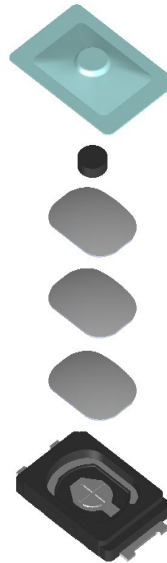

IP67
EVPAT



3.4mmx1.7mm
h=1.65mm
Travel: 0.08mm, 0.11mm
Life: 500K cycles

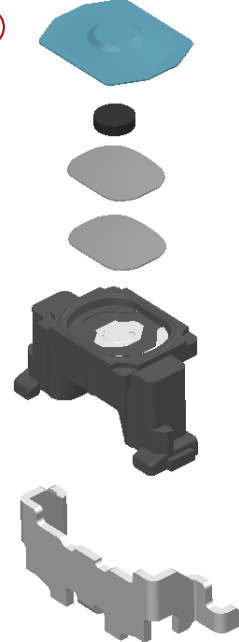

IP67
EVPBK



3.9mmx2.05mm
h=1.6mm
Travel: 0.12mm
Life: 500K cycles

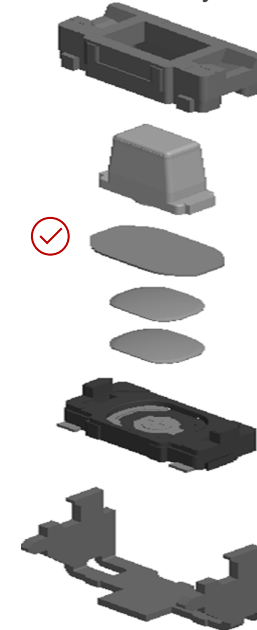

EVPBE



4.5mmx2.2mm
h=2.9mm
Travel: 0.13mm, 0.15mm
Life: 200K cycles

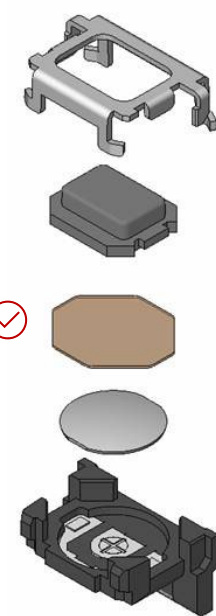

Light Touch Switch | High strength

High peel strength due to edge-mounted construction (substrate delamination)

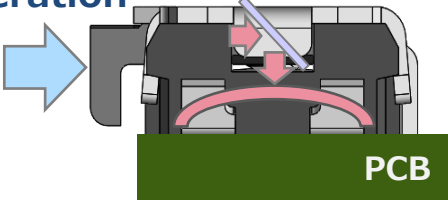
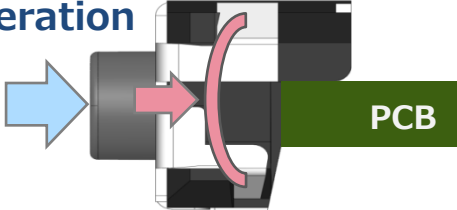
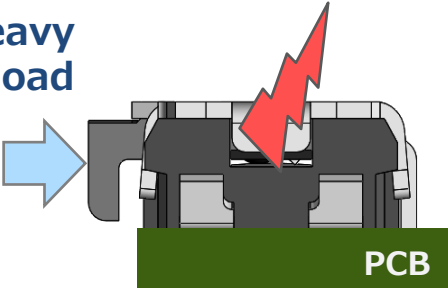
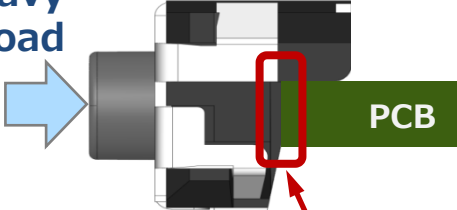
	Past	Edge-mount Type
Good feeling Long life	<p>Converts force direction 90° (friction occurs)</p> <p>operation</p>  <p>PCB</p> <p>Bad feeling due to friction</p>	<p>operation</p>  <p>PCB</p> <p>Directly push the movable contactor (without any influence of friction, etc.)</p> <p>Good feeling</p>
High peel-off strength	<p>Heavy load</p>  <p>PCB</p> <p>Peeled off</p>	<p>Heavy load</p>  <p>PCB</p> <p>Edge of PCB stops switch from peeled off</p>

EVPAE



4.5mmx2.2mm
h=2.9mm
Travel: 0.13mm,0.15mm
Life: 200K cycles

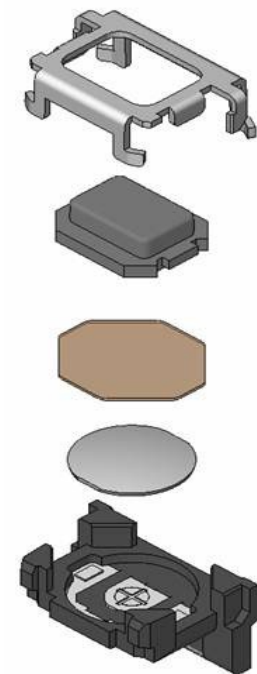

4.5mm x 2.2mm Edge Mount Light Touch Switch

Side operational switch with depth dimension (2.2mm) and high peel-off strength

Dimension

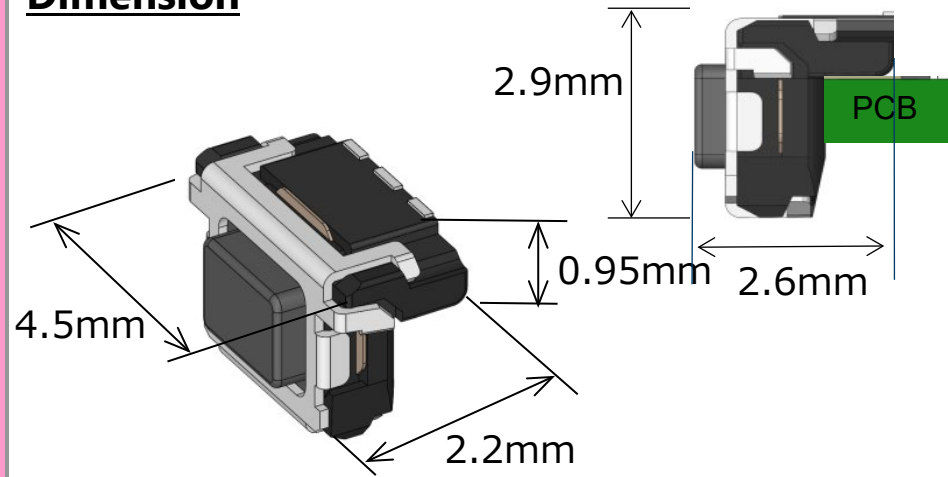

Features

- * Contribute to thinner system design
- * High peel-off strength

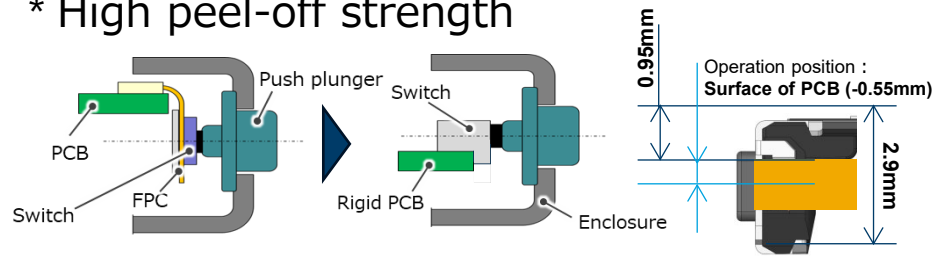

Land Pattern

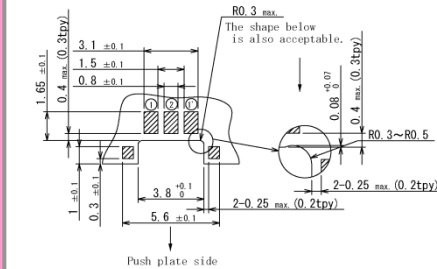

Circuit diagram

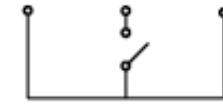

Major specifications

- * Operating force : 1.6N, 2.4N, 3.0N, 3.5N
- * Travel : 0.15mm (1.6N, 2.4N, 3.0N, 3.5N)
0.13mm (1.6N With L-shape terminals)
- * Life cycle : 200K
- * For automotive applications

Contribute to Various Set Designs

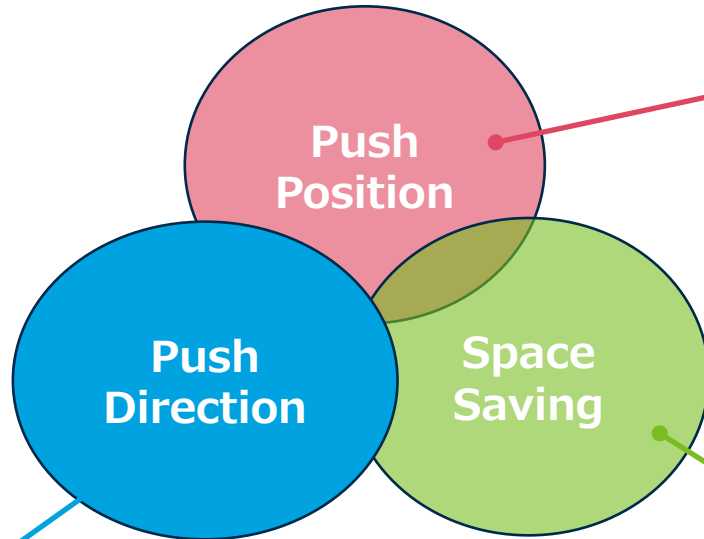

Push Position Varieties

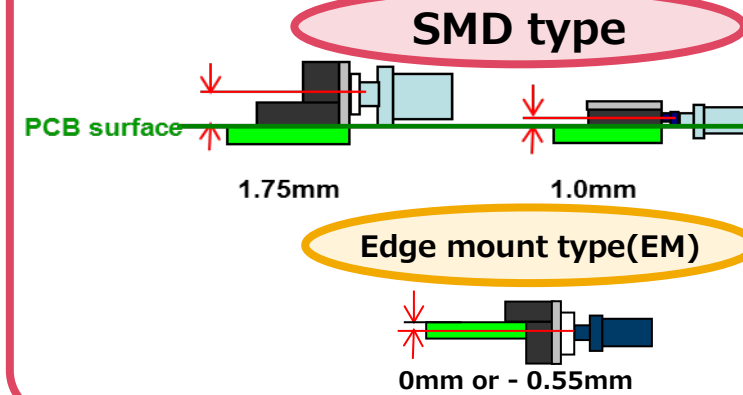

Push Direction Varieties

Top push type

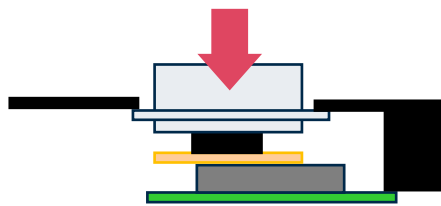

Side push type

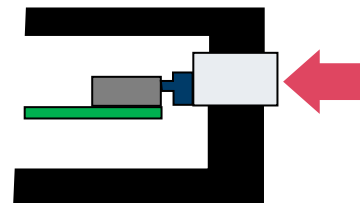

Smaller Size Varieties

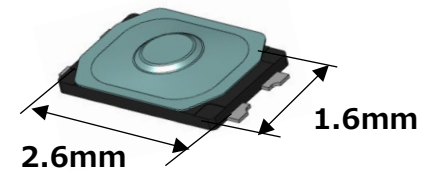

Top Push
The smallest width
in the world (2616type)

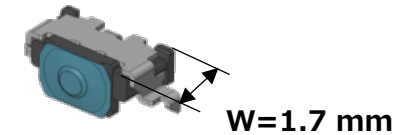

Side Push
The smallest width
in the world
(3417type)

Other | Mechanical Design (Top-push)

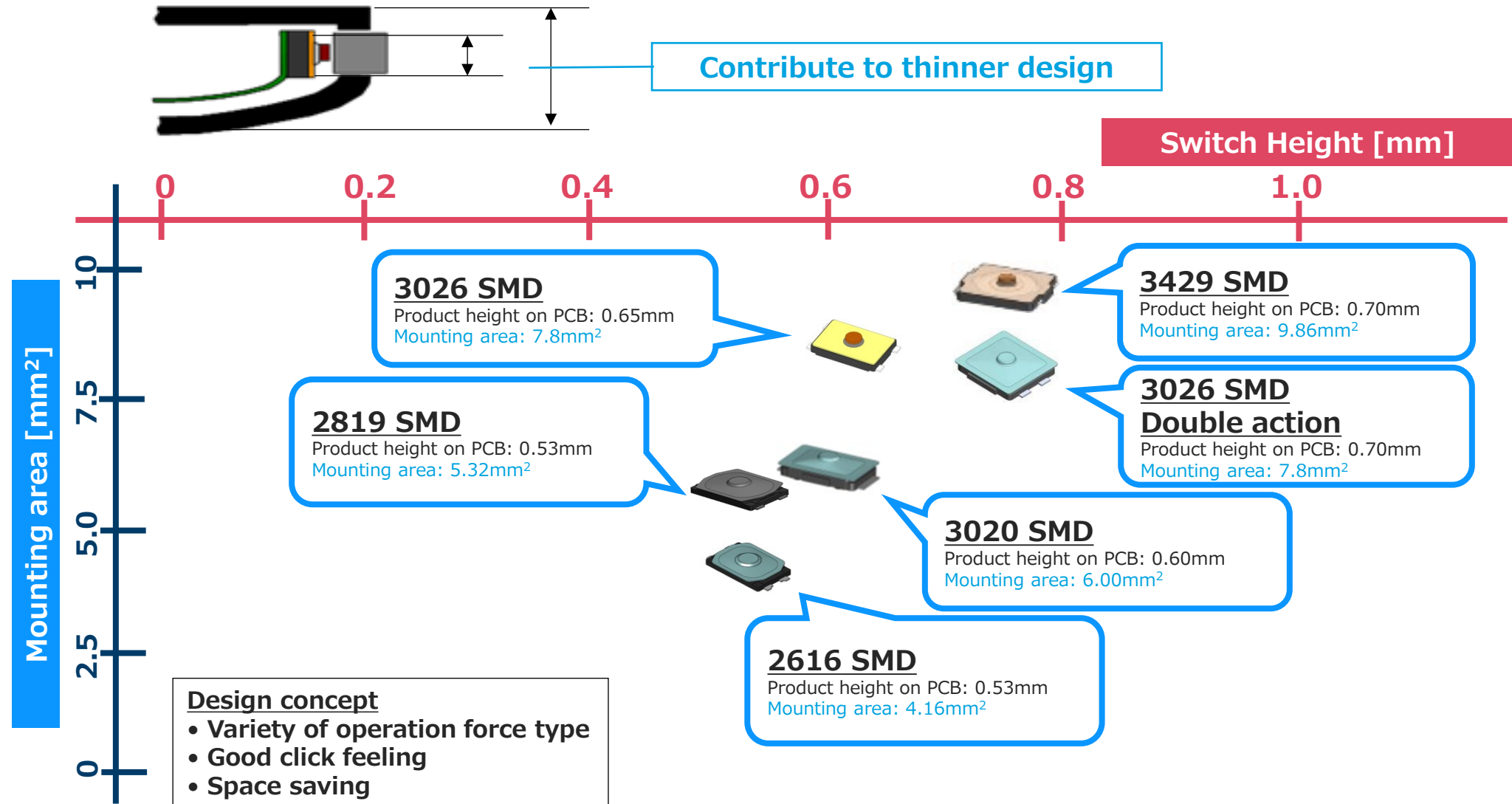

Other | Mechanical Design (Side-push)

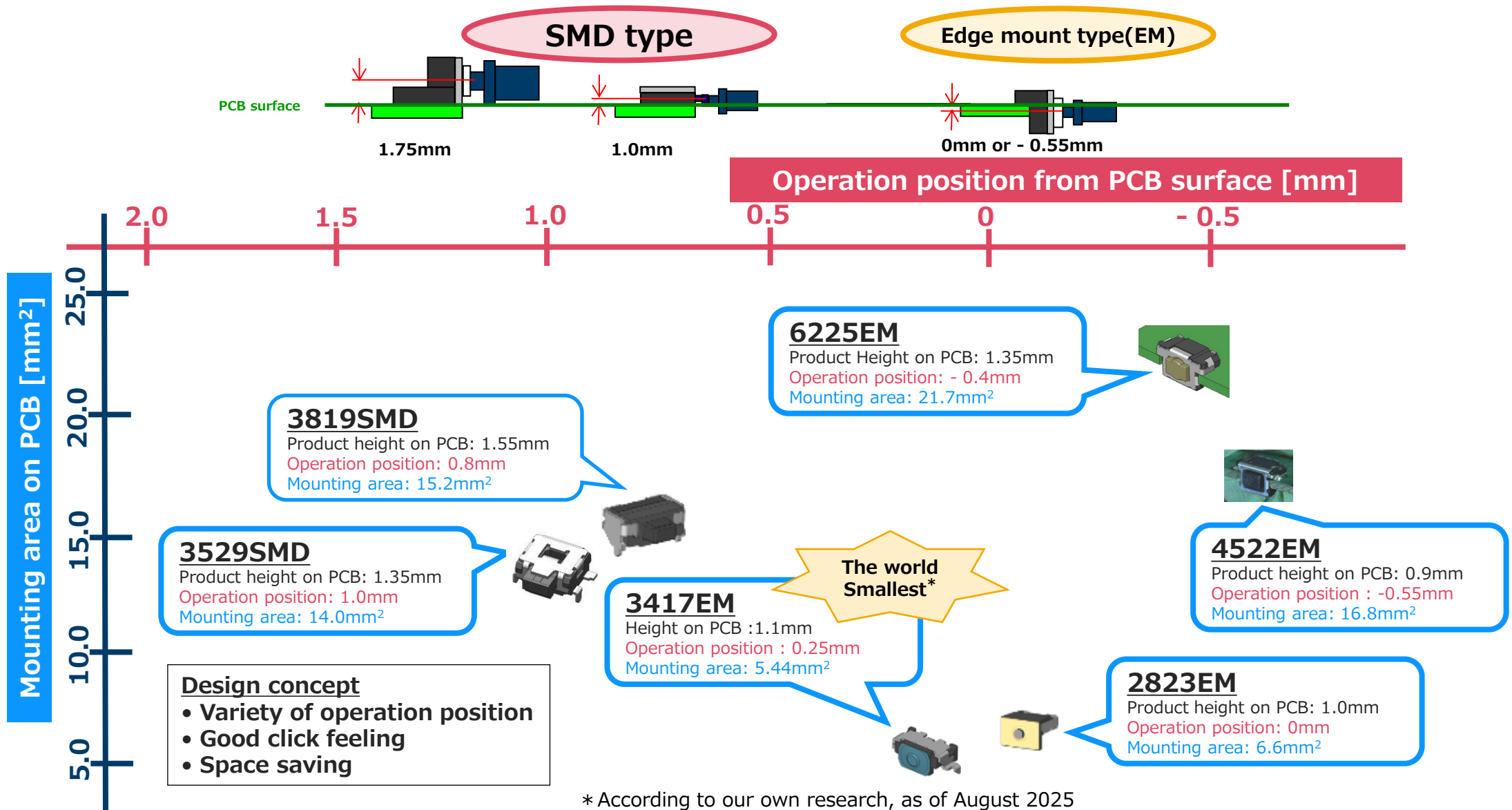

Rigid PCB mounting is possible for button placement on the side of the Enclosure

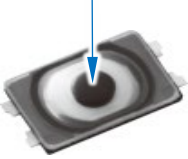
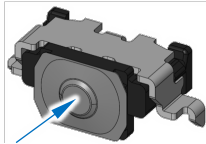
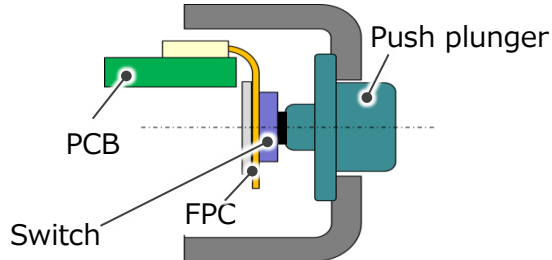
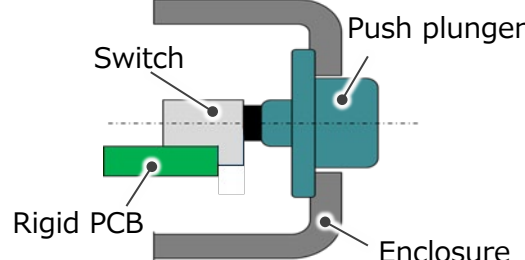
	Top push	Side push
Operating direction	<p>Operating direction is perpendicular to PCB</p> <p>Operating direction</p> 	<p>Operating direction is horizontal to PCB</p> 
Structure around button for side key		
Advantage	<ul style="list-style-type: none"> ✓ A lot of flexibility in device design, ✓ Higher peeling off strength. 	<ul style="list-style-type: none"> ✓ Can design thinner device thickness, ✓ Cost-competitive because of no FPC.
Dis-advantage	<ul style="list-style-type: none"> ✓ XY dimension of switch influences on device thickness. ✓ Not so cost-competitive because of FPC. 	<ul style="list-style-type: none"> ✓ Limited flexibility because of PCB position. ✓ Concerning about peeling off switch from rigid PCB.

Ensure reliability by optimal number of metal dome/plating technology

Metal dome



Multiple metal dome

Adjust the number of metal domes based on required operation force and life cycle



Achieve high operation force/ long life by dispersing stress with multiple metal dome structure.

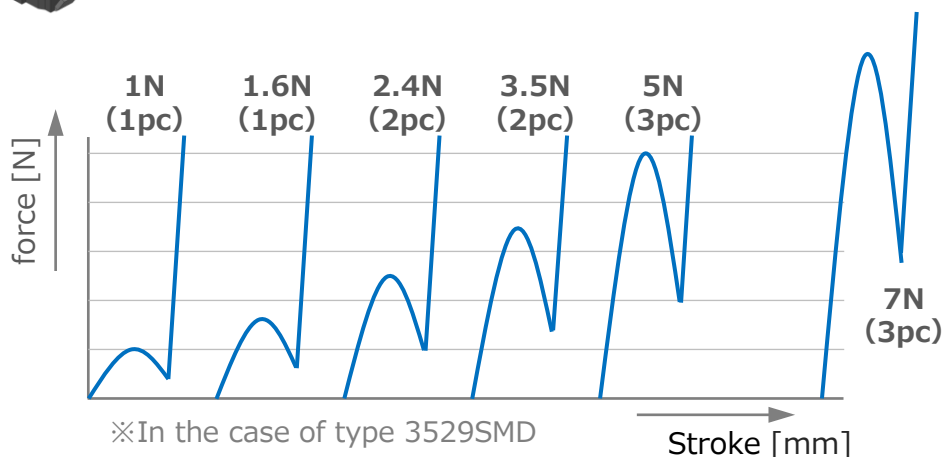

Plating

Our plating is more difficult to be worn down from high operation force and long push.

Plating Structure

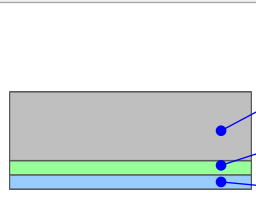
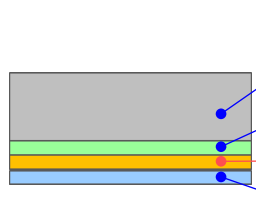
	Plating
General	 <ul style="list-style-type: none">Stainless steel (SUS)Ni PlatingAg Plating
Panasonic	 <ul style="list-style-type: none">Stainless steel (SUS)Ni PlatingCu PlatingAg Plating

Prevents plating worn-down by improves adhesion of plating by inserting Cu plating between Ag and Ni.

Operational sound evaluation technology

Control the operational sound while maintaining the click feeling

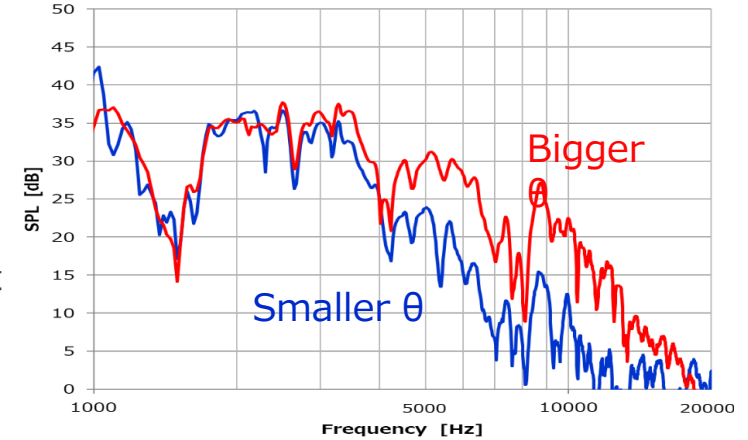
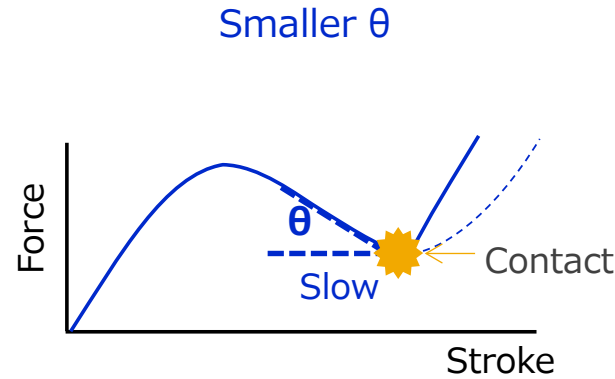
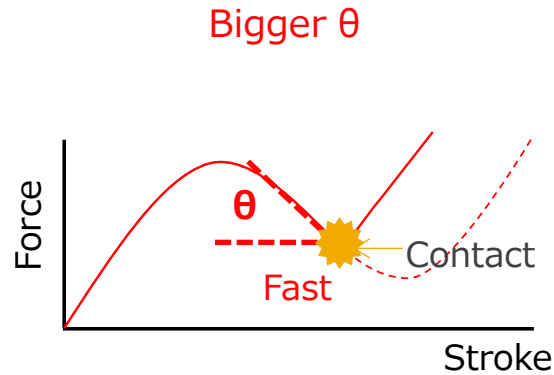

Sound measurement environment and analysis



Anechoic room(<NC20)

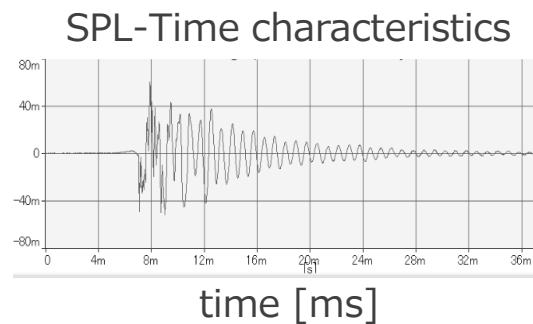

FFT

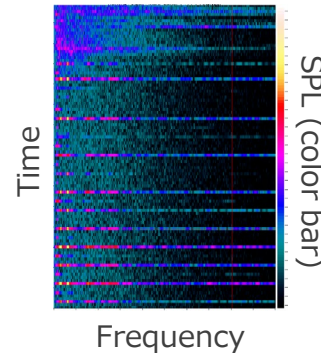

SPL-Frequency characteristics

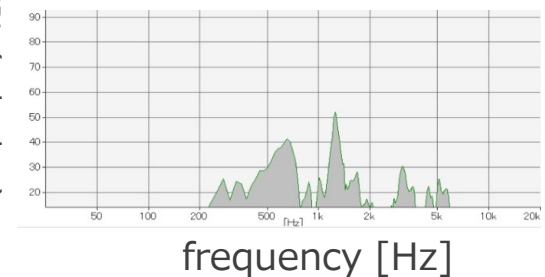

Detector switch for Smart watch and Smart glass

Detector switch for Smart glass

Menu, Mode setting

- As an operation switch (input device), detection for function and mode switching
- Space-saving detection of special operations such as slide, seesaw and rotation



•Two-way automatic return type

ESE23



4.4mmx5.0mm
h=1.5mm



•Space-saving arrangement by small switch

ESE16



2.2mmx3.35mm
h=1.5mm

ESE58



3.5mmx3.0mm
h=0.9mm

Cover open/close detection

- Space-saving placement with small switches
- Normally closed specifications reduce power



Space-saving arrangement by small switch

ESE13



4.2mmx3.6mm
h=1.2mm

ESE16



2.2mmx3.35mm
h=1.5mm

Supports normally closed specifications

ESE18



4.0mmx4.4mm
h=1.2mm

ESE58

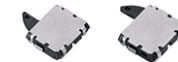

3.5mmx3.0mm
h=0.9mm

Needs trend for smart glass and the features of Detector switches

Detector switches supports a variety of applications

Smart glass

menu·mode setting

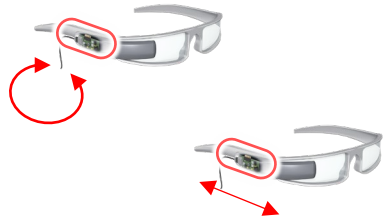

- ✓ Small and thin
- ✓ Lightweight
- ✓ Improved operability
- ✓ Light operation force
- ✓ Dustproof and Waterproof

Smart glass

Cover open/close detection



- ✓ Reduction of power consumption
- ✓ Light operation force
- ✓ High reliability

1. Designability

- Compatible with various operation modes
- Plenty of substrate mounting modes

*It is not equipped with a dustproof and waterproof structure, so please consider it as a set.

2. Proposal of various operation switches

- Realization of various operation switches such as rotation operation, slide operation, seesaw operation, etc.
- Light operation force

3. Reduction of power consumption

- Reduce power consumption of sets by using normal close specifications

Detector switches | Designability

- ◆ Small and abundant detection direction, operation mode and mounting method improve design freedom.
- ◆ Overstroke (through operation) allows detection of large movement amount even though it is small SW.

▶ Contribute to downsizing of device.

Size **2.2×3.35mm** Mounting height **0.9mm**

ESE16type



Circuit: N.O circuits
direction of operation:
vertical, horizontal
(Horizontal can be operated through)

ESE58type

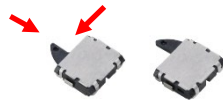

Circuit: N.O & N.C Circuit
Operating direction: Horizontal,
each two directions
(Horizontal operation can be
performed through)

▶ Contribute to customer's design flexibility.

	Top/Bottom	Right/Left	Bidirectional
Operation			
	DIP	SMD	Screw clamp
Mounting method			

ESE13type



Vertical detection
on PCB

ESE18type

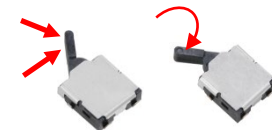

Horizontal
detection on PCB

ESE23type

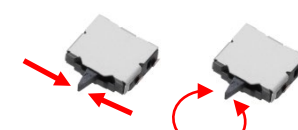

Two-way
detection

ESE11type



ESE22type



ESE24type



N.O= Normally open type, N.C= Normally Closed Type

Detector switches | Various operation

Enables set rotation, sliding, and seesaw operations

rotational operation

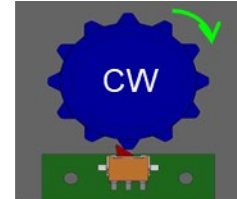
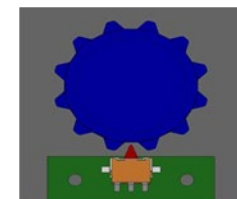
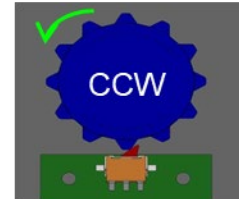
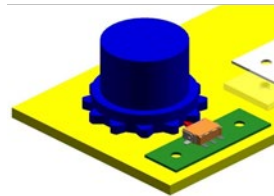

seesaw operation

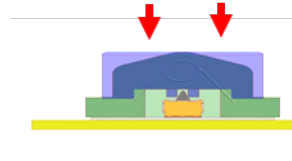

slide operation

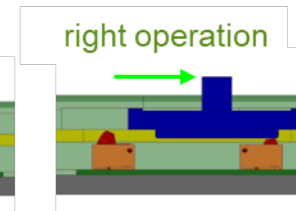
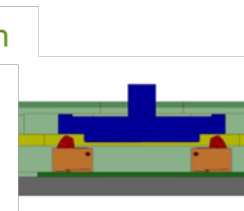
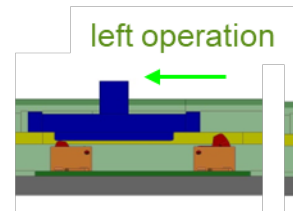
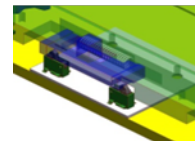

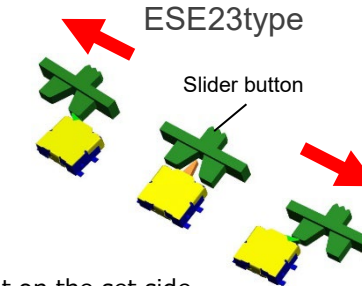
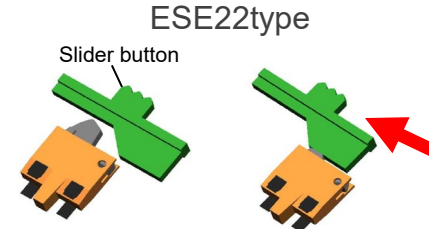
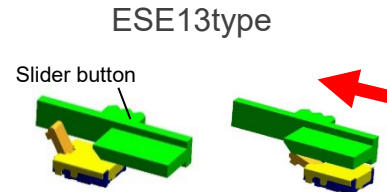
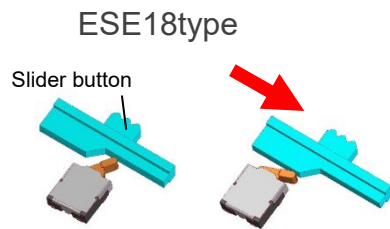

Slide operations (example)



*The click feel of the operation button and the recovery force are not provided by the switch. Please set it on the set side.
*The switch is not dustproof or waterproof. Please set it on the set side.

Detector switches | Reduction of power consumption

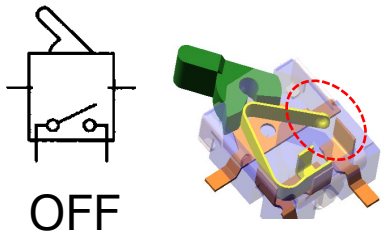
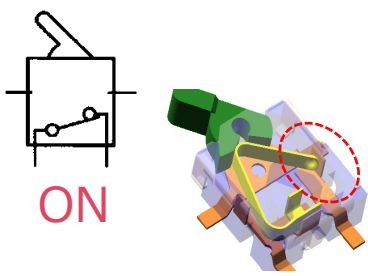
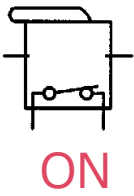
Switch with several circuit choices helps save power to the set

	N.O. (Normally Open type)	N.C. (Normally Closed type)
Normal position	 <p>OFF</p>	 <p>ON</p>
Lever Pressing	 <p>ON</p>	 <p>OFF</p>

<Compatible with normally closed (N.C.) specification>
 Type that **turns ON when operated (Normally open)**
 Type that **turns OFF when operated (Normally closed)**

▶ **Contribute to reduce power consumption.**
 Example/ Detection of an opening-closing cover

Cover closed state

Cover open state

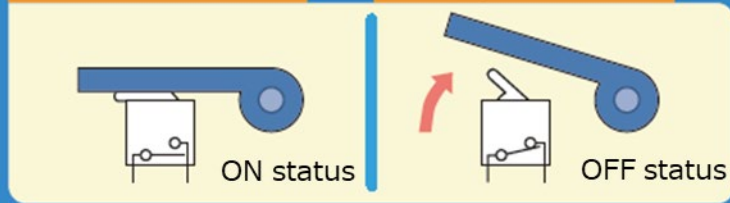
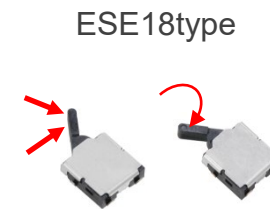
Body Size (mm) : 4.0×4.4×H1.2



Body Size (mm) : 3.5×3.0×H0.9

Circuit: N.O Circuit & N.C Circuit
 Operation direction: PCB in two horizontal directions
 (through operation is possible for horizontal operation)

Self-cleaning structure ensures high reliability of contacts

▶ Ensure high contact reliability with Original structure of plate spring wiping contacts.



- Quality stability with simple structure
- Long life
- Stable manufacturing

Structure (example)

ESE24type normal state

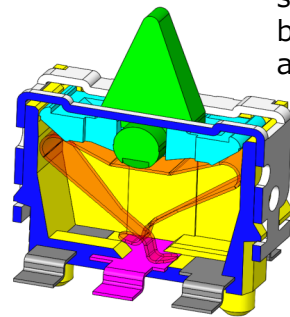

The spring force of the leaf spring makes stable contact between the "movable contact" and the "terminal."

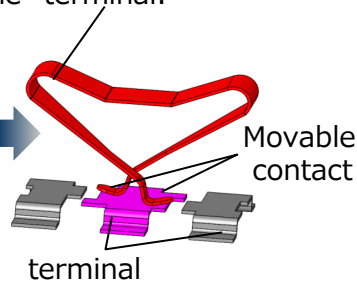

Example of lever left operation

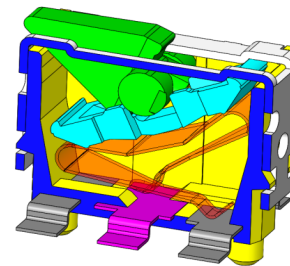

The "movable contact" of the operated leaf spring slides on the "terminal" and makes stable contact

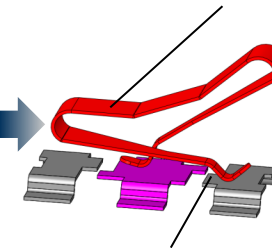

Leaf springs (movable contacts) provide stable quality and manufacturing through integrated automatic assembly from mold processing to assembly of raw materials.

Product leaflet

Top operational switch with small width dimension (1.6mm)

Dimension

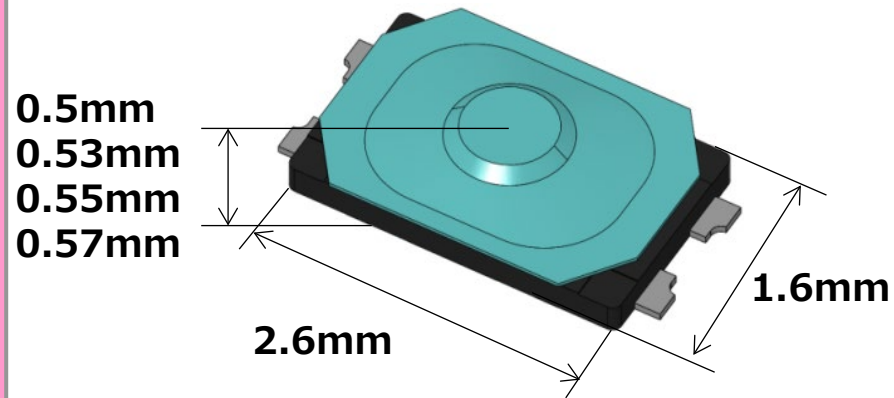

Features

- * Small width dimension (1.6mm)
- * Good feeling
(Click ratio ability target 50%)
- * High resistance against coating
by laser welding

Land Pattern

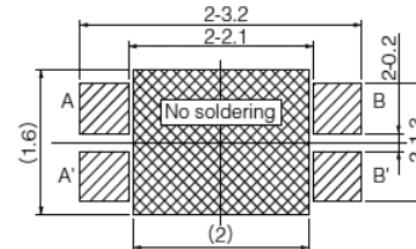

Circuit diagram

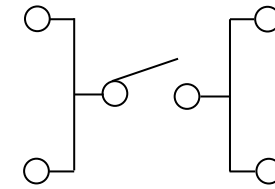

Major specifications

- * Operating force : 0.7N, 1.0N, 1.6N, 2.4N, 3.0N
- * Click ratio : 30% min.(0.7N,1.0N,3.0N)
40% min.(1.6N,2.4N)
- * Travel : 0.08mm(0.7N,1.0N)
0.11mm(1.6N,2.4N,3.0N)
- * Life cycle : 500K(1.0N,1.6N,2.4N,3.0N)
200K(0.7N)
- * IP67

Top operational switch with small width dimension (1.9mm)

Dimension

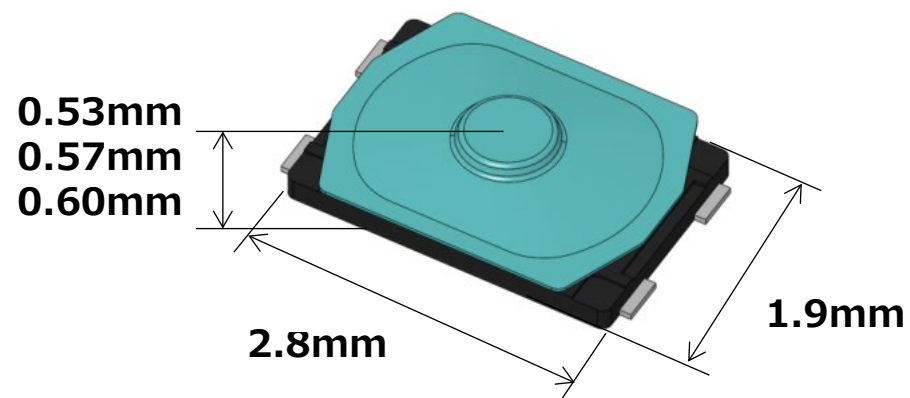

Features

- * Small width dimension
- * Good feeling
(Click ratio ability target 50%)
- * High resistance against coating
by laser welding

Land Pattern

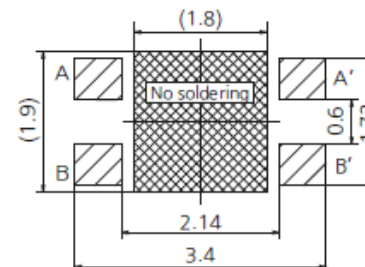

Circuit diagram

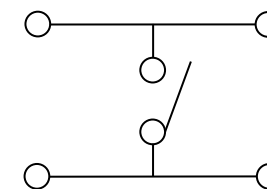

Major specifications

- * Operating force : 0.7N, 1.6N, 2.25N, 3.0N
- * Click ratio : 30% min.
- * Travel : 0.11mm(0.7N)
0.15mm(1.6N,2.25N,3.0N)
- * Life cycle : 300K
- * IP67

Top operational switch with small width dimension (2.0mm)

Dimension

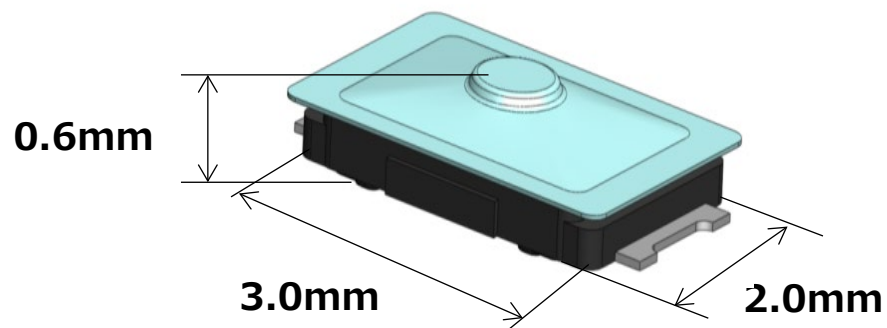

Features

- * Small width dimension (2.0mm)
- * Good feeling
(Click ratio ability target 50%)
- * High resistance against coating
by laser welding

Land Pattern

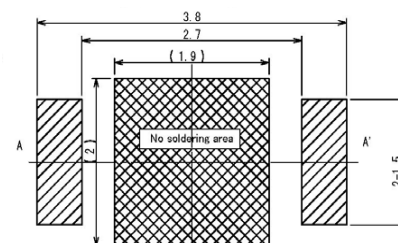

Circuit diagram

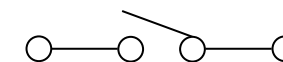

Major specifications

- * Operating force : 1.6N, 2.4N, 3.0N, 3.3N
- * Click ratio : 40% min.
- * Travel : 0.13mm (1.6N, 2.4N), 0.15mm (3.0N, 3.3N)
- * Life cycle : 500K(1.6N, 2.4N), 300K(3.0N, 3.3N)
- * IP67

High soldering strength with depth dimension(2.05mm)

Dimension

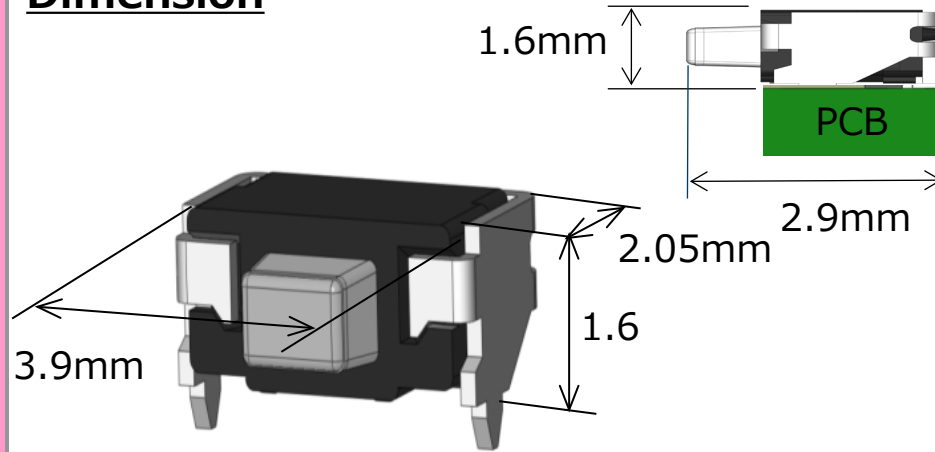

Features

- * Small size contributes smaller set design
- * High solder peeling-off strength
by the terminal insertion
- * Water-proofing with special sticking film

Land Pattern

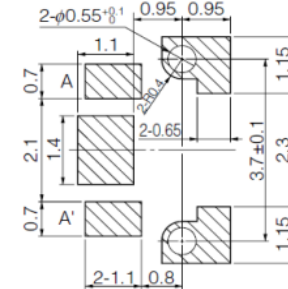

Circuit diagram



Major specifications

- * Operating force : 1.6N
- * Click ratio : 40% min.
- * Travel : 0.12mm
- * Life cycle : 500K
- * IP67

4.5mm x 2.2mm Edge Mount Light Touch Switch

Side operational switch with depth dimension (2.2mm) and high peel-off strength

Dimension

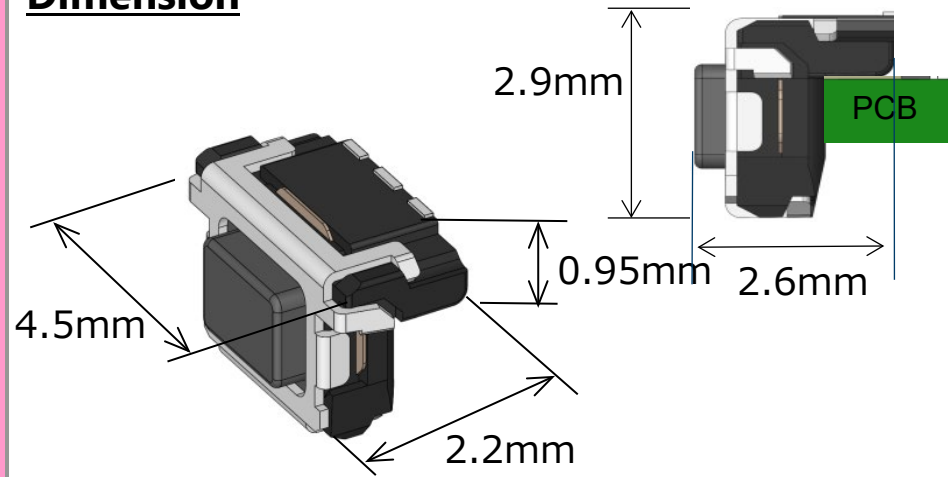

Features

- * Contribute to thinner system design
- * High peel-off strength

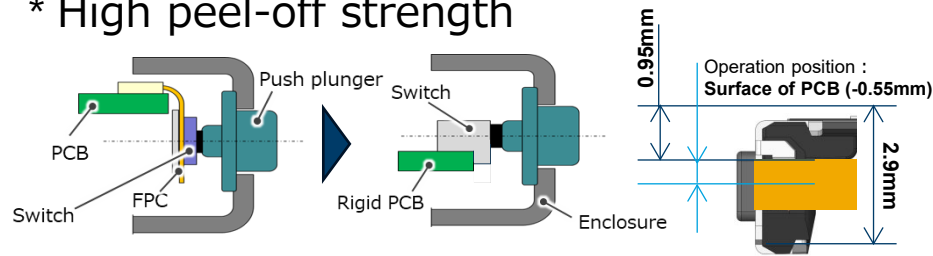

Land Pattern

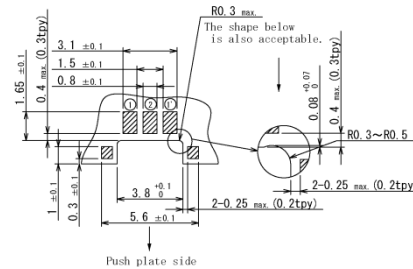

Circuit diagram

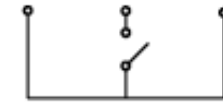

Major specifications

- * Operating force : 1.6N, 2.4N, 3.0N, 3.5N
- * Travel : 0.15mm (1.6N, 2.4N, 3.0N, 3.5N)
0.13mm (1.6N With L-shape terminals)
- * Life cycle : 200K
- * For automotive applications

Thin and Long Stroke

Dimension

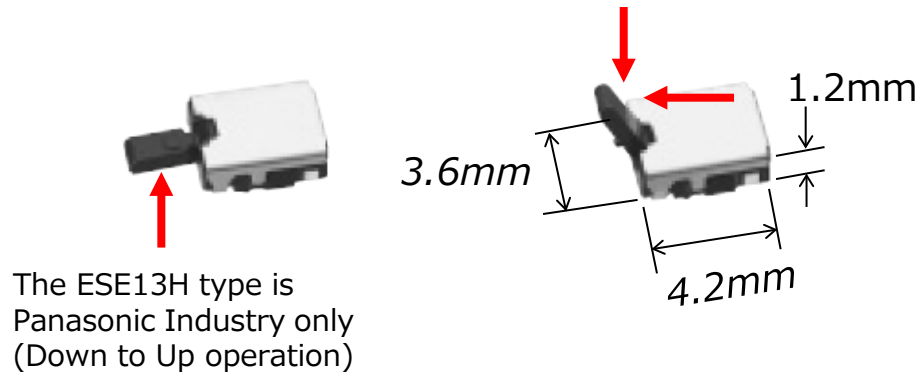

Features

- * Compact and Thin Compatible
(Body Thickness 1.2 mm)
- * Plenty of Operation Forms
(Only Panasonic can handle ESE13H type operations)
- * Halogen Free Compatible

Major specifications

- * Rated: 50 μ A 3 V DC to 10 mA 5 V DC
(resistive load)
- * Full stroke (indentation):
ESE13V Type 0.95 mm (2.1 mm)
ESE13H Type 3.05 mm (2.1 mm)
- * Operating force: 300 mN or less
- * Life: 50 k or more
- * Number of circuits and contacts:
1 circuit 1 contact
- * Circuit type: Normally open type (N.O.)

Small

Dimension

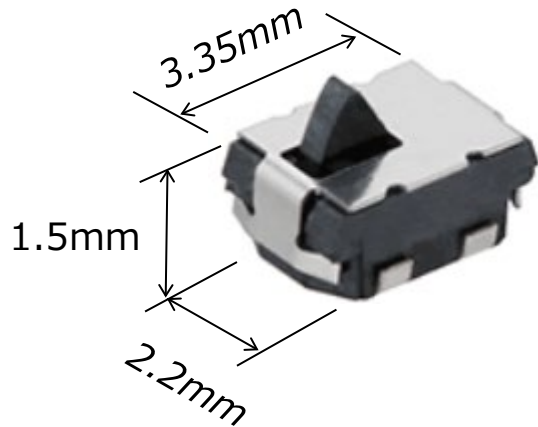

Features

- * Compact and Thin Compatible
(Body Thickness 1.2 mm)
- * Plenty of Operation Forms
(Only Panasonic can handle ESE13H type operations)
- * Halogen Free Compatible

Major specifications

- * Rated: 50 μ A 3 V DC to 10 mA 5 V DC
(resistive load)
- * Full stroke (indentation):
1.5 mm (1.0 mm)
- * Operating force: 250 mN or less
- * Life: 50 k or more
- * Number of circuits and contacts:
1 circuit 1 contact
- * Circuit type: Normally open type (N.O.)

Thin and N.O./N.C. compatible

Dimension

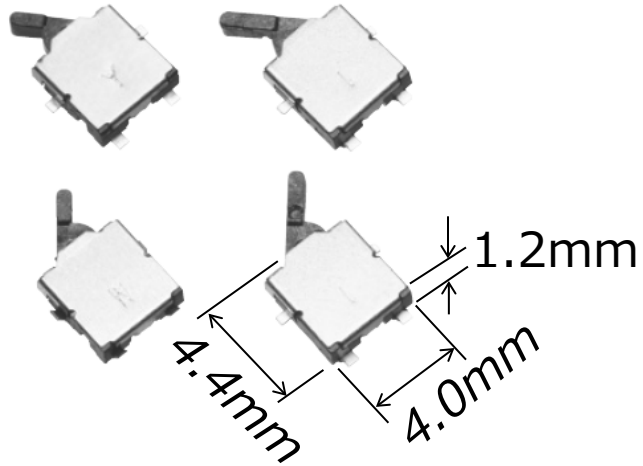

Features

- * Compact and Thin Compatible (Body Thickness 1.2 mm)
- * Plenty of Variations (Right or left operation, N.O. or N.C. circuit compatible, lever length (Standard or Long), Terminal type)
- * Halogen Free Compatible

Major specifications

- * Rated: 50 μ A 3 V DC to 10 mA 5 V DC (resistive load)
- * Full stroke (indentation):
 - Standard stroke type
 - With boss 1.4 mm (1.5 mm)
 - Without boss 2.1 mm (1.5 mm)
 - Long stroke type
 - With boss 1.4 mm (2.15 mm)
 - Without boss 2.1 mm (2.15 mm)
- * Working force: 300 mN or less
- * Life: 50 K or more
- * Number of circuits and contacts:
 - 1 circuit 1 contact
- * Circuit type: Normally open type (N.O.)
Normally closed type (N.C.)

A switch that can detect in two directions with a single switch

Dimension

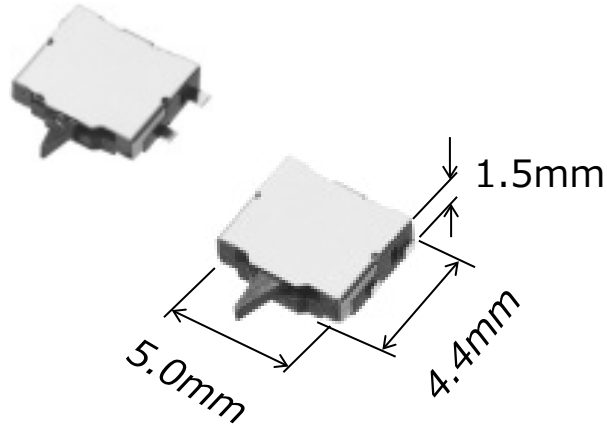

Features

- * Compact and Thin Compatible (Body Thickness 1.5 mm)
- * Long Overstroke
- * Thin, Two-Way Operation, and Automatic Midway Return Type
- * Halogen Free Compatible

Major specifications

- * Rated: 50 μ A 3 V DC to 10 mA 5V DC (resistive load)
- * Full stroke (indentation):
With boss 1.0 mm (1.5 mm)
Without boss 2.2 mm (1.5 mm)
- * Working force: 300 mN or less
- * Life: 50 K or more
- * Number of circuits and contacts:
1 circuit 2 contacts (midpoint OFF)
- * Circuit type: Normally open type (N.O.)

Industry's Thinnest Level *

(* According to our own research, as of August 2025)

Dimension

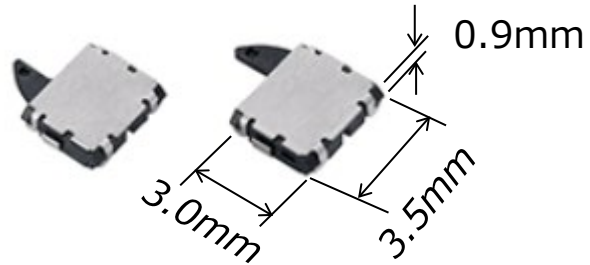

Features

- * Compact and Thin Compatible
(Body Thickness 0.9 mm)
- * Right or left operation, N.O. or N.C. circuit,
With Boss or Without Boss
- * Allows horizontal and vertical manipulation

Major specifications

- * Rated: 50 μ A 3 V DC to 10 mA5V DC
(resistive load)
- * Full stroke (indentation):
With boss 1.5 mm (1.4 mm)
Without boss 1.25 mm (1.4 mm)
- * Working force: 300 mN or less
- * Life: 50 K or more
- * Number of circuits and contacts:
1 circuit 2 contacts (midpoint OFF)
- * Circuit type: Normally open type (N.O.)
Normally closed type (N.C.)

Panasonic
INDUSTRY