

## SMTLA5050RGB

- ◆ Integrated high-quality external control single-wire serial cascaded constant current IC
- ◆ Built-in data shaping circuit
- ◆ Built-in power-on reset and power-off reset circuit
- ◆ Gray adjustment circuit
- ◆ Balanced color matching
- ◆ Single-wire data transmission, unlimited cascading
- ◆ Low Profile Package
- ◆ High Luminous Intensity
- ◆ Wide Viewing Angle
- ◆ High Power Efficiency

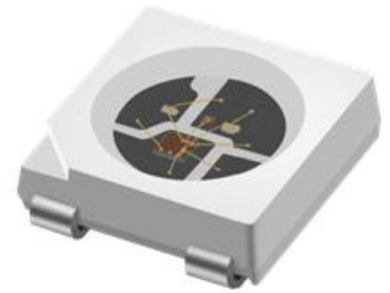

SMTLA5050 is an intelligent controlled LED light source that integrates a control circuit and a light-emitting circuit. Its appearance is the same as the industry standard SMTL6 5050 SMD LED, and each element is a pixel. The pixel contains an intelligent digital interface data latch signal shaping amplifier drive circuit, a power supply voltage regulator circuit, a built-in constant current circuit, a high-precision RC oscillator, and the output drive adopts patented PWM technology to effectively ensure the color consistency of the pixel light. The SMTLA5050 has the advantages of low voltage drive, environmental protection and energy saving, high brightness, large scattering angle, good consistency, ultra-low power, and ultra-long life. Integrating the control circuit on the LED makes the circuit simpler, smaller in size, and easier to install.

Part Number	Emitted Color	Dominant Wavelength (nm)	Luminous Intensity Typ. mcd	Lens Color	Viewing Angle
SMTLA5050RGB	Red	623	300	Water Clear	120°
	Green	523	1000		
	Blue	467	225		

## Outline Dimensions

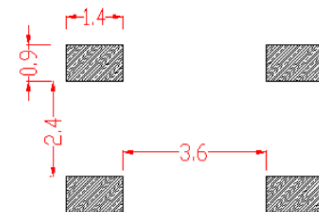
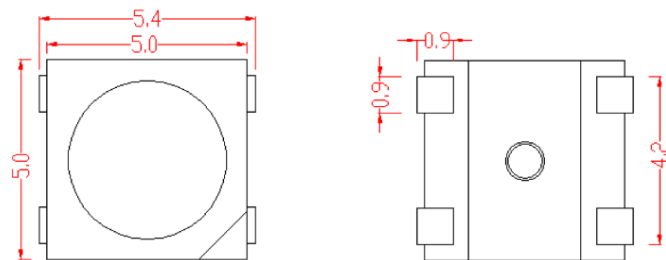

Recommended size of solder pad

### Outline Drawings Notes:

1. All dimensions are in millimeters.
2. Standard tolerance:  $\pm 0.25\text{mm}$  unless otherwise noted.
3. Package size: 5.0 x 5.4 x 1.6mm



Bivar reserves the right to make changes at any time without notice.

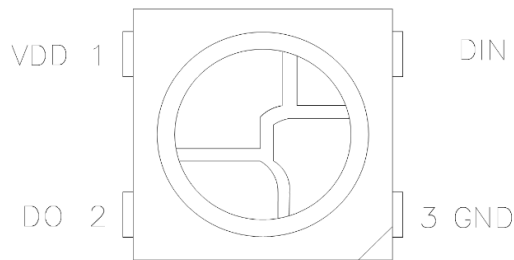

Pin No	Symbol	Pin Name	Function Description
1	VDD	power	chip power supply pin
2	DO	data output	control data signal output
3	GND	ground	signal and power connect ground
4	DIN	data input	control data signal input

### Absolute Maximum Ratings

T<sub>A</sub> = 25°C unless otherwise noted

Logic Power Supply Voltage (V <sub>DD</sub> )	3.5 to 7.5 V
Logic Input Voltage (V <sub>I</sub> )	-0.5 to +5.5 V
Electrostatic Withstand Voltage (V <sub>ESD</sub> )	4000 V
Shelf Life	1 year
Operating Temperature Range	-40 - +85°C
Storage Temperature Range	-40 - +120°C

Notes: 1. 10% Duty Cycle, Pulse Width ≤ 0.1 msec. 2. Solder time less than 10 seconds at maximum temperature.

**Handling:** (1) Reflow soldering must not be performed more than twice. Hand soldering must not be performed more than once.  
(2) Sensitive to static electricity or surge voltage. Proper handling required to avoid ESD damage and impair LED reliability.

### Electrical / Optical Characteristics

T<sub>A</sub> = 25°C & I<sub>F</sub> = 12 mA unless otherwise noted

Emitting Color	Logic Power Supply Voltage (V) <sup>1</sup>			Recommended Forward Current (mA)			Dominant Wavelength (nm)			Luminous Intensity I <sub>v</sub> (mcd) <sup>3</sup>			Viewing Angle 2 Θ ½ (deg)
	MIN	TYP	MAX	MIN	TYP	MAX	MIN	TYP	MAX	MIN	TYP	MAX	TYP
Red	3.5	5.0	7.5	/	12	/	620	625	630	200	250	300	120°
Green				/	12	/	520	525	530	600	700	800	
Blue				/	12	/	465	470	475	200	250	300	

- Notes: 1. Tolerance of forward voltage: ±0.05V.  
2. Tolerance of Recommended Forward Current: ±2mA.  
3. Tolerance of dominant wavelength: -1.0nm of MIN & +1nm of MAX.  
4. Tolerance of luminous intensity: ±10%

Bivar reserves the right to make changes at any time without notice.

## Integrated Circuit

### Electrical Specifications

Parameter name	Symbol	Min	Typical	Max	Unit	Test conditions
R/G/B output port withstand voltage	$V_{ds}$	8.5	9	9.5	V	-
R/G/B output drive current	$I_o$	9.6	12	14.4	mA	-
High level input voltage	$V_{IH}$	0.7 $V_{DD}$	0.9 $V_{DD}$	1.0 $V_{DD}$	V	-
Low-level input voltage	$V_{IL}$	0 $V_{DD}$	0.1 $V_{DD}$	0.3 $V_{DD}$	V	-
DO source current capability	$I_{DOH}$	--	15	--	mA	-
DO source current capability	$I_{DOL}$	--	30	--	mA	-
PWM frequency	$F_{PWM}$	3	4	5	KHZ	-
Static power	$I_{DD}$	0.6	0.8	1	mA	-

### Dynamic Parameter

Parameter name	Symbol	Min	Typical	Max	Unit	Test conditions
Data transfer rate	$F_{DIN}$	--	800	1100	KHZ	--
Transmission delay time	$T_{PLZ}$	--	--	200	ns	DIN→DO
Output current conversion time	$T_r$	--	--	400	ns	$V_{ds}=1.5V$ $I_O=12mA$
	$T_f$	--	--	400	ns	

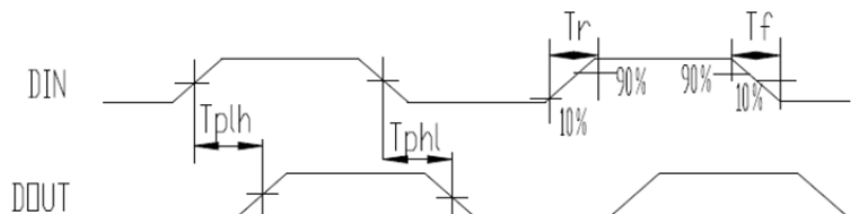

Bivar reserves the right to make changes at any time without notice.



G	G	G	G	G	G	G	G	R	R	R	R	R	R	R	R	B7	B6	B5	B4	B3	B2	B1	B0
7	6	5	4	3	2	1	0	7	6	5	4	3	2	1	0								

Note: The high bit is sent first, and the data is sent in the order of GRB (G7→G6.....B0)

## Typical Application Circuit

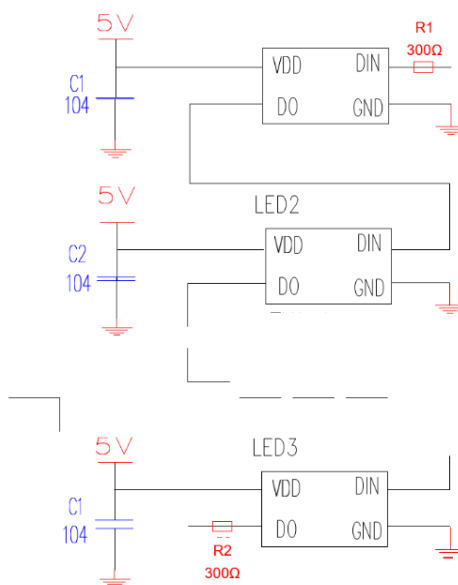

## CAUTIONS:

This product has been thoroughly tested to ensure the internal IC proper yield and products stability after the soldering reflow process, recommending the following considerations during product validation.

1. Incoming material inspection: Confirm the integrity of the vacuum sealed package to confirm humidity integrity. If a leakage is detected and/or the humidity card indicates that the LEDs are compromised, recommend returning the LEDs to Bivar for replacement or baking.
2. Samples validation: The LED's internal IC has to be properly tested, and a plan has to be established to perform samples evaluation ensuring that the product meets specified performance parameters.
3. Before use: An LED should not be exposed to air for longer than 4 hours, which may result in potential humidity absorption. The LED should be reflow processed within 2 hours following SMT completion.
4. Product use and baking needs: An open package must be completely used within 4 hours of opening and should the 4-hour window be exceeded, baking is recommended as per IPC JEDEC J-STD-033B.1 Section 9 and per MSL level.
5. Special considerations: Prior to use and for the LED package integrity, need to place attention to baking needs, as well as storage temperature and humidity control, should the product remain at room temperature longer than the specified MSL level. The time of year will also have an impact on ESD conditions and products' life, therefore recommend strict compliance with the above-mentioned points.

### Directivity Radiation

T<sub>A</sub> = 25°C unless otherwise noted

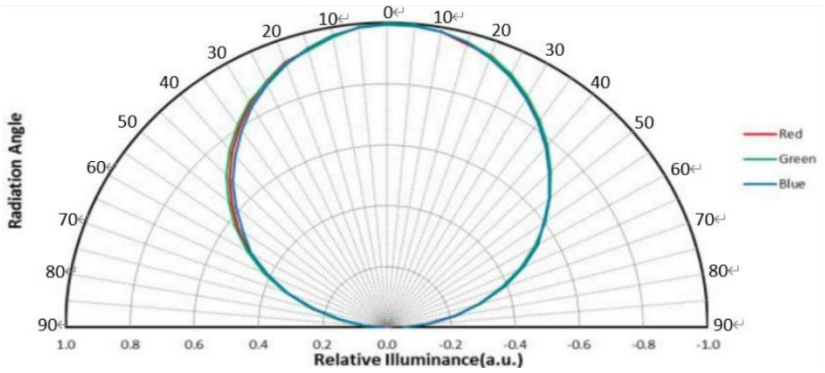

Radiation Diagram

### Typical Electrical / Optical Characteristics Curves

T<sub>A</sub> = 25°C unless otherwise noted

#### ■ Spectrogram · T<sub>A</sub>=25°C

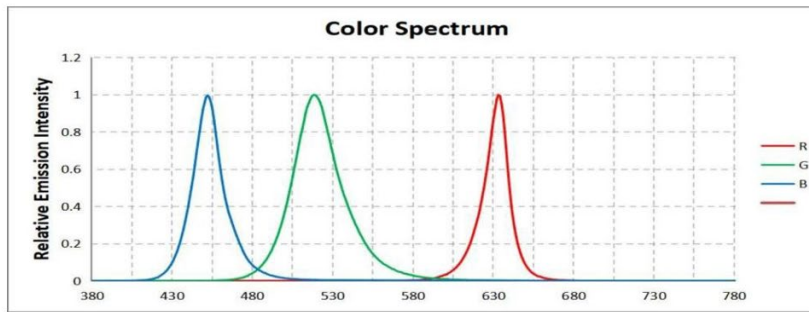

#### ■ Relationship between voltage and current · T<sub>A</sub>=25°C

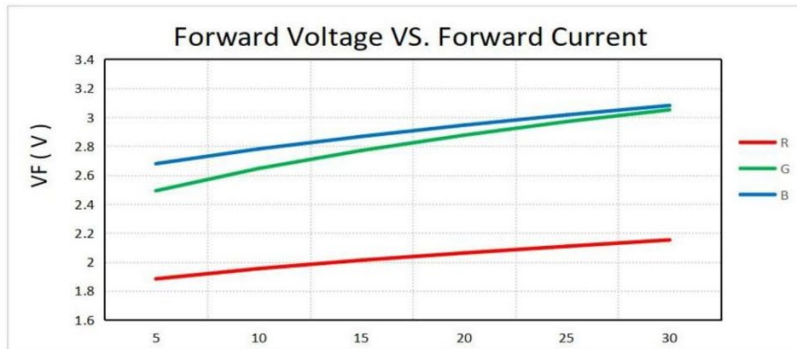

#### ■ Relationship between brightness and current, T<sub>A</sub>=25 °C

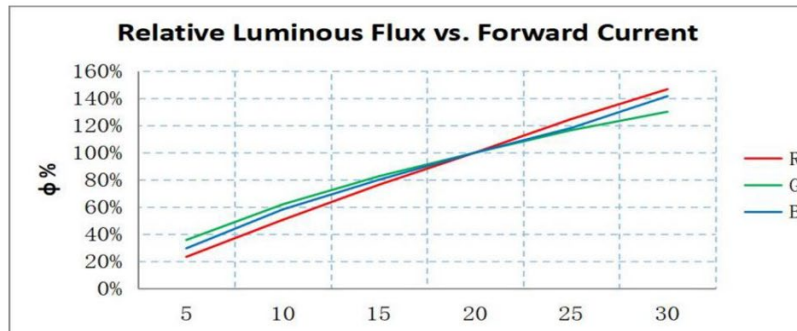

Bivar reserves the right to make changes at any time without notice.

# SMD Top View Package Addressable LED SMTLA5050RGB, Red, Green, Blue



## Tape and Reel Dimensions

Note: Reel Size: 178 x 12mm, 1000 pcs/Reel

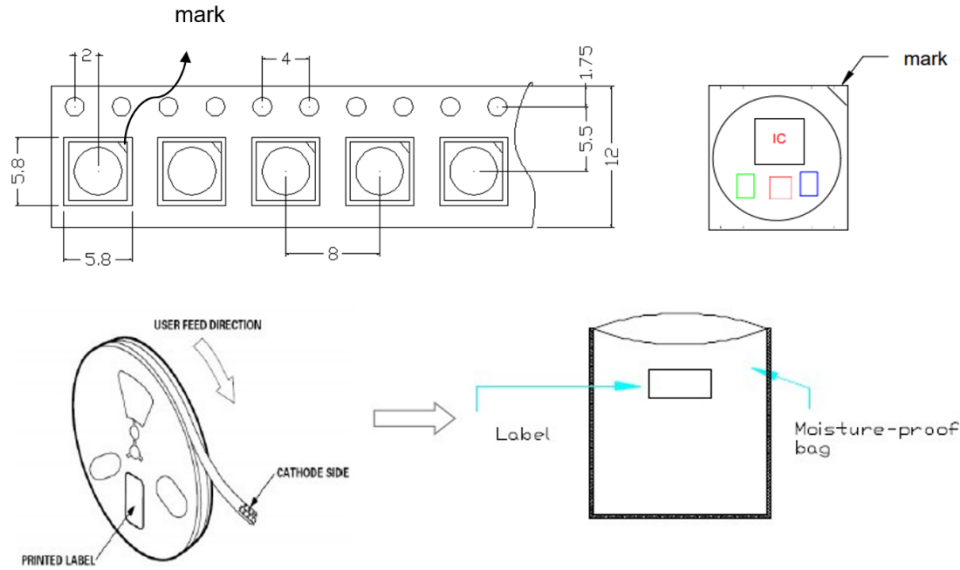

## Packaging and Labeling Plan

Note: 1 Reel / Bag

Sealed ESD and Moisture Barrier Bag

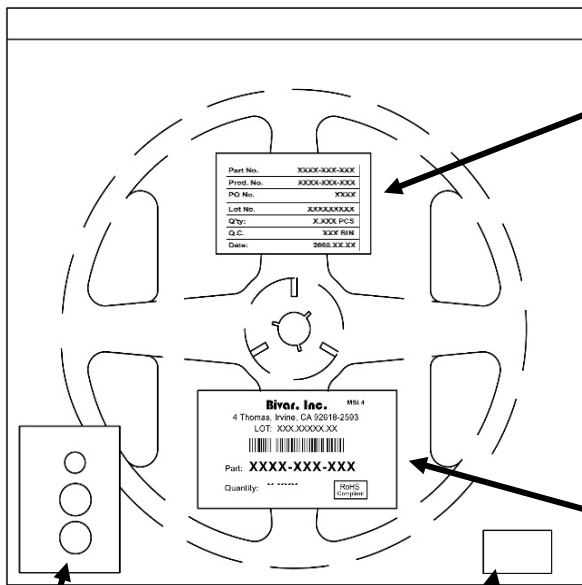

Humidity Indicator Card

Desiccant

Part No.	XXXX-XXX-XXXX
PO No.	XXXX
Lot No.	XXXXXXXXXX
Q'ty:	XXXX PCS
Q.C.	
Date:	2025.XX.XX

Internal Quality Control Label

		MSL: 5a	
(1P) Supplier Part #:	<b>SMTLXXXXYY</b>		
(Q) Quantity:	<b>XXXX</b>	Unit of Measure: <b>EA</b>	
(10D) Date Code:	<b>XXXX</b>		
(1T) Lot Code:	<b>XXXXXXXXXX</b>		
(4L) Country of Origin:	<b>XX</b>	% Overage: 0 %	
		Weight per 100 pcs. (g): 3	
Additional Information: NA			
<b>BIVAR</b> 4 Thomas Irvine CA, 92618		<b>RoHS Compliant</b> Labeled By: JE Printed on: 03/04/25 13:01	

Bivar reserves the right to make changes at any time without notice.



## Storage:

Before Opening the Package: The LEDs should be kept at 30°C or less and 90% RH or less. The LEDs should be used within a year. When storing the LEDs, moisture proof packaging with absorbent material (silica gel) is recommended.

After Opening the Package: The LEDs should be kept at 30°C or less and 70% RH or less. The LEDs should be soldered within 72 hours (3 days) after opening the package. If unused LEDs remain, they should be stored in moisture proof packages, such as sealed containers with packages of moisture absorbent material (silica gel). It is also recommended to return the LEDs to the original moisture proof bag and to reseal the moisture proof bag again.

If the moisture absorbent material (silica gel) has faded away or the LEDs have exceeded the storage time, baking treatment should be performed using the following condition: BAKE TREATMENT – more than 24 hours at 65 +/-°C.

LED electrode sections are comprised of silver-plated copper alloy. The silver surface may be affected by environments which contain corrosive gases and so on. Please avoid conditions which may cause the LED to corrode, tarnish or discolor. This corrosion or discoloration may cause difficulty during soldering operations. It is recommended that the user uses the LEDs as soon as possible. Avoid rapid transitions in ambient temperature, especially in high humidity environments where condensation can occur.

## Moisture Proof Package:

When moisture is absorbed into the SMT package, it may vaporize and expand during soldering. There is a possibility that this can cause exfoliation of the contacts and damage to the optical characteristics of the LEDs. For this reason, the moisture proof package is used to keep the moisture to a minimum in the package.

The moisture proof package is made of an aluminum moisture proof bag with a zipper. A package of a moisture absorbent material (silica gel) is inserted into the aluminum moisture proof bag. The silica gel change its color from blue to pink as it absorbs moisture.

## Heat Management & Design Considerations

\*\*\* Heat generation must be controlled during LED use. The temperature of the chips is affected by the thermal resistance of the PCB and LED density configuration.

\*\*\* Attention should be made to circuit board design for effective heat dispersion and therefore, not allowing the LED joint temperature exceed the absolute maximum rated value.

\*\*\* In addition, the current should be determined shall be determined based on the Ambient Temperature surrounding the LED, and appropriate heat dissipation shall be implemented.

## Static Electricity

\*\*\* It is recommended that a wrist band or an anti-electrostatic glove be used when handling the LEDs since Static electricity or surge voltage may potentially damage the LEDs.

\*\*\* It is recommended that measures be taken against surge voltage to the equipment that mounts the LEDs, where all related devices, equipment and machinery must be properly grounded.

\*\*\* It is recommended to check whether the assembled LEDs are damaged by static electricity during final product inspection in which LEDs were assembled. Recommend conducting a functional test with rated  $V_F$  and low 1mA current to find static-damaged LEDs.

\*\*\* Damaged LEDs may behave such as the leak current is significantly increased, the forward voltage becomes is reduced, or the LEDs do not light with the low test current. CRITERIA: ( $V_F > 2.0V$  at  $I_F=0.5mA$ )

## Cleaning

\*\*\* It is recommended to use isopropyl alcohol for cleaning the LEDs. Shall be confirmed beforehand if other solvents can be utilized to verify if the package or the resin can be negatively impacted. Freon solvents should not be used to clean the LEDs due to worldwide regulations.

\*\*\* Do not clean the LEDs by ultrasonic means. If absolutely necessary, a pre-test should be performed to confirm whether any damage to the LEDs may occur before proceeding to clean. Ultrasonic cleaning impact on the LEDs may be impacted by factors such as ultrasonic power and the assembled conditions.

## Others

\*\*\* Recommend avoiding looking directly into the LEDs without proper eye protection for more than a few seconds, since the emitted high intensity light output may potentially injure the human eyes.

\*\*\* Flashing lights are known to potentially cause discomfort to certain people and shall take precautions when LEDs are flashing. Should also be cautious when using equipment which use LEDs as light or indication sources.

\*\*\* Intended applications of the LEDs in this datasheet are for common electronic equipment (such as office and communications equipment, measurement instruments, industrial usage and appliances. Consult Bivar in advance for information on the applications in which exceptional quality and reliability are required, particularly when the failure or



malfunction of the LEDs may directly impact on the life or health of the LEDs such as for aerospace, automotive, traffic control equipment, life support systems, safety devices or other similar applications.

\*\*\* User shall not reverse engineer under any circumstances the LEDs by disassembling or performing specialized analysis thereof, without Bivar's knowledge or consent. When defective LEDs are found, the user should inform Bivar for proper analysis, troubleshooting and resolution for course of action.

\*\*\* Formal design and specifications reviewed and agreed with Bivar prior to high volume ramp up is confirmed.

\*\*\* Product changes for the purpose of improving and/or for material changes can be implemented without notice.

The LED contains silicone encapsulation, rendering soft the top part of the LED. Mechanical stress may impact its reliability. Handle with and avoid contact with the encapsulation.

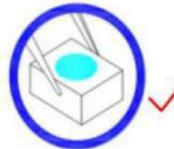

## Surface Mounting Condition

In automatic mounting of the SMD LEDs on printed circuit boards, any bending, expanding and pulling forces or shock against the SMD LEDs shall be kept minimum to prevent them from electrical failures and mechanical damages of the device.

## Reflow Soldering

Soldering of the SMD LEDs shall conform to the soldering conditions in the individual specifications. SMD LEDs are designed for Reflow Soldering. In the reflow soldering, too high temperature and too large temperature gradient such as rapid heating / cooling may cause electrical and optical failure and damage of the devices. Bivar cannot guarantee the LED after they have been assembled using the solder dipping method.

## Reflow Soldering Time Profile

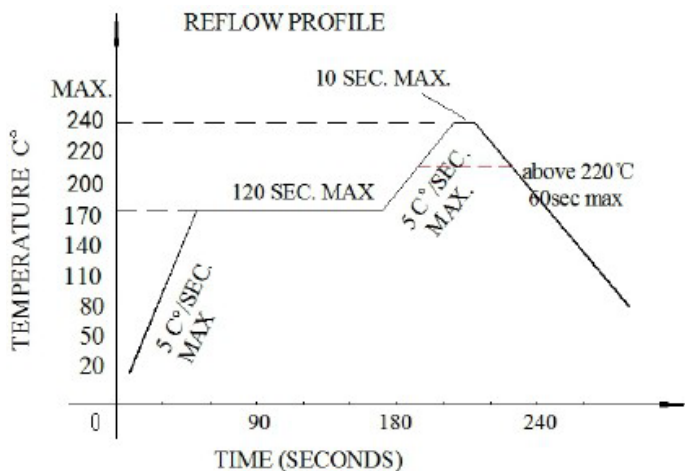

1. Reflow soldering should not be done more than 2 times.
2. When soldering, do not put stress on the LEDs during heating.

## Soldering Iron

1. Keep the temperature under 300 within 3 seconds when soldering.
2. The hand soldering should be done only one time.
3. Any rework should be done within 5 seconds under 240°C
4. Head of the iron cannot touch the LEDs.
5. Do not touch silicone encapsulation while taking the LED.
6. Twin-Head Type is preferred.

Bivar reserves the right to make changes at any time without notice.

## Reliability Test Item and Conditions

### Results of Reliability Test

Item	Test Item	Ref. Standard	Test Conditions	Note	Conclusion
1	Reflow Soldering	JESD22-B106	Tsld=240°C,10sec	3times	0/22
2	Temperature Cycle	JESD22-A104	-20°C 30min ↑↓ 15min 120°C 30min	200cycle	0/22
3	Thermal Shock	JESD22-A106	-40°C 15min ↑↓ 15sec 125°C 15min	200cycle	0/22
4	High Temperature Storage	JESD22-A103	T <sub>a</sub> =100°C	1000hrs	0/22
5	Low Temperature Storage	JESD22-A119	T <sub>a</sub> =-40°C	1000hrs	0/22
6	Power temperature Cycling	JESD22-A105	On5min-40°C>15min ↑↓ <15min ↑↓ Off 5min100°C>15min	200cycle	0/22
7	Life Test	JESD22-A108	T <sub>a</sub> =25°C IF=12mA	1000hrs	0/22
8	High Humidity Heat Life Test	JESD22-A101	60°CRH=90% IF=12mA	1000hrs	0/22

Bivar reserves the right to make changes at any time without notice.

## Definition of Moisture Resistance

Moisture resistance level verification						
Moisture resistance level	Life span after un packing		Verification condition			
	Time	Condition	Standard conditions		Accelerated conditions	
			Time	Condition	Time	Condition
LEVEL1	Unlimited	$\leq 30^{\circ}\text{C}/85\%\text{RH}$	168+5/-0H	85°C/85%RH	/	/
LEVEL2	1year	$\leq 30^{\circ}\text{C}/60\%\text{RH}$	168+5/-0H	85°C/60%RH	/	/
LEVEL2 a	4weeks	$\leq 30^{\circ}\text{C}/60\%\text{RH}$	696+5/-0H	30°C/60%RH	120+5/-0H	60°C/60%RH
LEVEL3	168hours	$\leq 30^{\circ}\text{C}/60\%\text{RH}$	192+5/-0H	30°C/60%RH	40+5/-0H	60°C/60%RH
LEVEL4	72hours	$\leq 30^{\circ}\text{C}/60\%\text{RH}$	96+5/-0H	30°C/60%RH	20+5/-0H	60°C/60%RH
LEVEL5	48hours	$\leq 30^{\circ}\text{C}/60\%\text{RH}$	72+5/-0H	30°C/60%RH	15+5/-0H	60°C/60%RH
LEVEL5 a	24hours	$\leq 30^{\circ}\text{C}/60\%\text{RH}$	48+5/-0H	30°C/60%RH	10+5/-0H	60°C/60%RH
LEVEL6	Take out And use	$\leq 30^{\circ}\text{C}/60\%\text{RH}$	Take out and use	30°C/60%RH	/	/

Bivar reserves the right to make changes at any time without notice.