

# T30R R-GAGE Sensor Instruction Manual



Original Instructions  
p/n: 217048 Rev. F  
June 22, 2023

© Banner Engineering Corp. All rights reserved.

# Contents

---

<b>Contents .....</b>	<b>2</b>
<b>Chapter 1 Product Description</b>	
T30R Models .....	5
T30R Overview .....	6
T30R Features and Indicators .....	7
Radar Configuration Software .....	8
<b>Chapter 2 Installation Instructions</b>	
Sensor Orientation .....	9
Mount the Device Using the Threaded Barrel .....	9
T30R Wiring .....	10
<b>Chapter 3 Getting Started</b>	
Install the Software .....	11
Connect to the Sensor .....	11
Software Overview .....	12
<b>Chapter 4 Banner Radar Configuration Workspace</b>	
Navigation Toolbar .....	13
Live Sensor Data and Legend .....	13
Summary Pane .....	14
Sensor Settings Pane .....	14
General Tab .....	14
Analog Tab .....	15
Discrete 1 Tab .....	16
Discrete 2 Tab .....	16
Live Sensor Data Controls.....	17
<b>Chapter 5 Configuring a Sensor</b>	
Banner Radar Configuration Software .....	19
IO-Link Interface .....	19
Remote Input .....	19
Remote Teach.....	22
Remote Setup.....	22
Push Button Configuration .....	25
Reset the Sensor to Factory Defaults .....	25
Factory Default Settings .....	26
Using Measurement Hold Example .....	27
<b>Chapter 6 T30R Specifications</b>	
FCC Part 15 Class A .....	30
Industry Canada Statement for Intentional Radiators .....	30
PC Requirements .....	31
T30R Dimensions .....	31
Beam Patterns .....	32
<b>Chapter 7 Update the Software .....</b>	<b>35</b>
<b>Chapter 8 Accessories</b>	
Brackets .....	37
Cordsets .....	38
Configuration Tool .....	39
<b>Chapter 9 Product Support and Maintenance</b>	
Repairs .....	41

Contact Us .....	41
Banner Engineering Corp. Software Copyright Notice .....	41
Banner Engineering Corp Limited Warranty .....	41
Document Information .....	42

*Blank page*

Chapter Contents

T30R Models ..... 5  
 T30R Overview ..... 6  
 T30R Features and Indicators ..... 7  
 Radar Configuration Software ..... 8

# Chapter 1 Product Description

Radar-based sensors for detecting and measuring moving and stationary targets



- FMCW radar detects moving and stationary objects
- Adjustable sensing field—ignores objects beyond setpoint
- Easy setup and configuration of range, sensitivity, and output using the Banner Radar Configuration Software
- Sensing functions are immune to wind, fog, steam, and temperature changes and resistant to rain and snow
- Compact, rugged IP67 housing withstands harsh environments
- Available in a variety of beam patterns, including models optimized for near-range sensing

**WARNING:**



- Do not use this device for personnel protection**
- Using this device for personnel protection could result in serious injury or death.
- This device does not include the self-checking redundant circuitry necessary to allow its use in personnel safety applications. A device failure or malfunction can cause either an energized (on) or de-energized (off) output condition.

## T30R Models

The lens on the sensor and the bandwidth the sensors scans affects the performance of the sensor.

T30R-1515 models have a rounded lens that helps focus the signal and creates a narrower sensing beam.

**NOTE:** If there is a very strong radar target 50 m (164 ft) away or farther from the sensor, it could cause false detection inside of the sensing range.

*T30R-1515 Models (15 x 15 degree beam pattern)*

Models	Detection Range	Supply Voltage	Telecom Approved	Output
T30R-1515-KIQ	0.15 m to 15 m (0.5 ft to 49.2 ft)	10 V DC to 30 V DC	US, Europe, UK, Australia, New Zealand, and Malaysia	Analog current (4 mA to 20 mA and 1 NPN/PNP discrete), IO-Link
T30R-1515-KUQ		12 V DC to 30 V DC		Analog voltage (0 V to 10 V or 0.5 V to 4.5 V, and 1 NPN/PNP discrete), IO-Link
T30R-1515-KDQ		10 V DC to 30 V DC		Dual discrete (NPN/PNP), Pulse Pro, IO-Link

Continued on page 6

Continued from page 5

Models	Detection Range	Supply Voltage	Telecom Approved	Output
T30R-1515-LKIQ	0.15 m to 25 m (0.5 ft to 82 ft)	10 V DC to 30 V DC	US, Europe, UK, Australia, New Zealand, and Malaysia	Analog current (4 mA to 20 mA and 1 NPN/PNP discrete), IO-Link
T30R-1515-LKUQ		12 V DC to 30 V DC		Analog voltage (0 V to 10 V or 0.5 V to 4.5 V, and 1 NPN/PNP discrete), IO-Link
T30R-1515-LKDQ		10 V DC to 30 V DC		Dual discrete (NPN/PNP), Pulse Pro, IO-Link

The T30R-4545 models have a flat lens which allows for a much wider sensing beam.

*T30R-4545 Models (45 x 45 degree beam pattern)*

Models	Detection Range	Supply Voltage	Telecom Approved	Output
T30R-4545-KIQ	0.30 m to 10 m (1 ft to 32.8 ft)	10 V DC to 30 V DC	US, Europe, UK, Australia, New Zealand, and Malaysia	Analog current (4 mA to 20 mA and 1 NPN/PNP discrete), IO-Link
T30R-4545-KUQ		12 V DC to 30 V DC		Analog voltage (0 V to 10 V or 0.5 V to 4.5 V, and 1 NPN/PNP discrete), IO-Link
T30R-4545-KDQ		10 V DC to 30 V DC		Dual discrete (NPN/PNP), Pulse Pro, IO-Link

The standard T30R-1515 and T30R-4545 have a narrower bandwidth sweep, which provides exceptional performance across most of the sensor's range but declines in the near range. The T30R-1515-C near-range models sweep across a wider bandwidth and with that added information have a smaller dead zone and improved performance in the near field, as well as maintaining that performance across its range.

*T30R-1515-C Models (15 x 15 degree beam pattern)*

Models	Detection Range	Supply Voltage	Telecom Approved	Output
T30R-1515-CKIQ	0.10 m to 6 m (0.3 ft to 19.7 ft)	10 V DC to 30 V DC	US	Analog current (4 mA to 20 mA and 1 NPN/PNP discrete), IO-Link
T30R-1515-CKUQ		12 V DC to 30 V DC		Analog voltage (0 V to 10 V or 0.5 V to 4.5 V, and 1 NPN/PNP discrete), IO-Link
T30R-1515-CKDQ		10 V DC to 30 V DC		Dual discrete (NPN/PNP), Pulse Pro, IO-Link

Integral 5-pin M12 quick disconnect models are listed. To order the 150 mm (6 in) PUR cable model with a M12 quick disconnect, replace the suffix 'Q' with "QP" in the model number. For example, **T30R-1515-KIQP**.

## T30R Overview

The T30R is an industrial radar sensor that uses high frequency radio waves from an internal antenna. It detects high-dielectric targets, such as metal or large amounts of water, and lower-dielectric materials, such as wood, rock, or organic material. The sensor can be configured with software, IO-Link, remote input wires, or push buttons to sense objects up to a specific distance, ignoring objects beyond this distance (background suppression). Or the sensor can be taught a reference point to detect the presence or absence of an objects (retroreflective).

*Sensing Range*  
Sensing Range

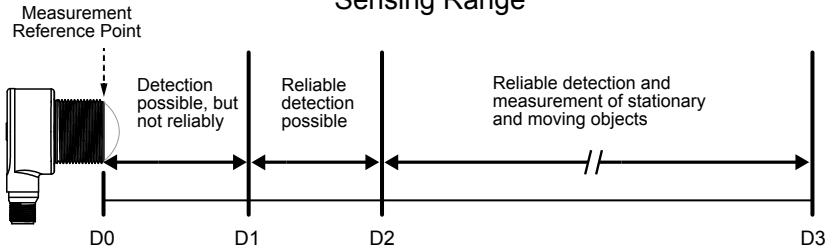

Model	D0 (m)	D1 (m)	D2 (m)	D3 (m)
T30R-1515 Models	0	0.15	0.20	15
T30R-1515-C Models	0	0.10	0.10	6
T30R-1515-L Models	0	0.15	0.20	25
T30R-4545 Models	0	0.30	0.30	10

## T30R Features and Indicators

*T30R Features*

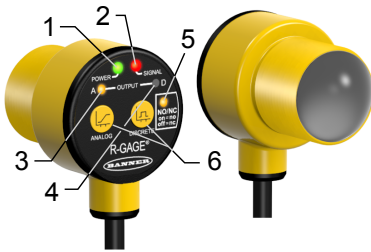

	LED	Color	Description
1	Power	Green	Power ON
2	Signal Strength	Red	Flashes in proportion to the signal strength
3	Output 1	Amber	Target is within the taught analog span or discrete output status
4	Output 2	Amber	Discrete output status
5	NO/NC	Amber	Normally open/normally closed status of discrete output. Dual discrete models have two LEDs.
6	n/a	n/a	Output Teach buttons

**Signal Strength LED**

Off: The signal strength less than one.

Flashing: The flashing is in proportion to the signal strength. The frequency increases as the signal strength increases from greater than 1× the user-selected signal strength threshold to 4× the signal strength threshold.

On: The signal strength is greater than 4× the user-selected signal strength threshold.

**Output LEDs**

Indicate that a target is present within the taught range and the signal strength is above the required signal strength threshold.

## Radar Configuration Software



Use Banner's Radar Configuration Software to:

- Set up the sensor 3 easy steps: set the switch point distance, signal strength threshold, and response time
- Easily monitor device status via the software
- Visualize the application in real-time
- Make adjustments to sensor settings on the fly

For more information, visit [www.bannerengineering.com/us/en/products/sensors/software/radar-configuration.html](http://www.bannerengineering.com/us/en/products/sensors/software/radar-configuration.html).



## Chapter Contents

Sensor Orientation .....	9
Mount the Device Using the Threaded Barrel .....	9
T30R Wiring .....	10

## Chapter 2 Installation Instructions

### Sensor Orientation

Correct sensor-to-object orientation is important to ensure proper sensing.

Minimize the tilt angle of a target relative to the sensor. The target should be tilted less than half of the beam angle.

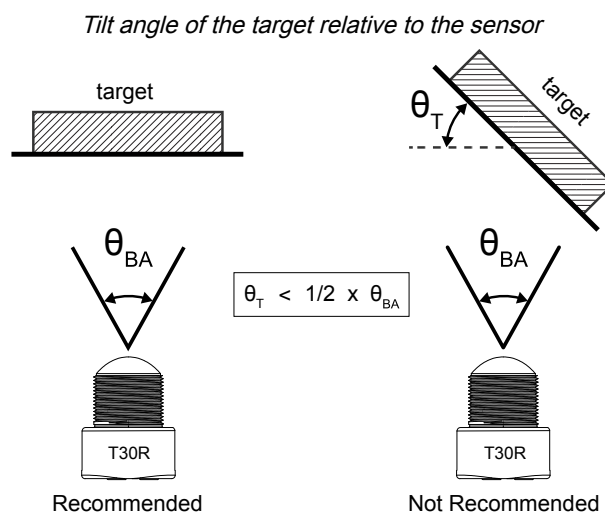

T= Target Angle, BA=Beam Angle

### Mount the Device Using the Threaded Barrel

1. If your device came with a lock washer, place the lock washer on the barrel of the device.
2. Insert the barrel of the device through a hole or a bracket.
  - If desired and available, insert the device through an appropriately sized hole in the machine or equipment at the desired location.
  - If a bracket is needed, insert the device into the bracket.
3. Thread the mounting nut onto the barrel of the device, finger tight.
4. If using a bracket, mount the device and the bracket to the machine or equipment at the desired location. Do not tighten the mounting screws at this time.
5. Check the device alignment, aiming it near parallel to, or down towards, the ground.
 

If aiming at a target, alignment and signal strength can be checked via the red Signal Strength LED or the Banner Radar Configuration Software.
6. Tighten the nut.
7. If using a bracket, tighten the mounting screws to secure the device and the bracket in the aligned position.

# T30R Wiring

Quick disconnect wiring diagrams are functionally identical.

*Push-pull Output and Analog Current Output*

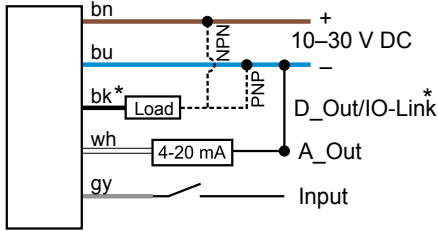

\* Push-Pull output. User-configurable PNP/NPN setting.

*Push-pull Output and Analog Voltage Output*

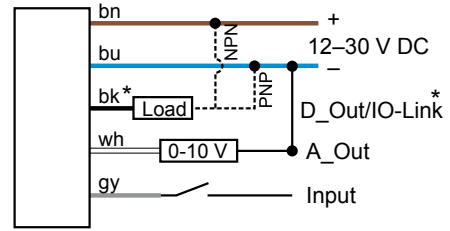

\* Push-Pull output. User-configurable PNP/NPN setting.

*Dual Discrete Output*

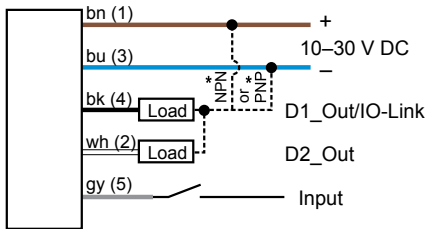

\* Push-Pull output.  
User-configurable PNP/NPN setting.

**Key:**

- 1 = Brown
- 2 = White
- 3 = Blue
- 4 = Black
- 5 = Gray (Connect for use with remote input or Banner Radar Configuration software)

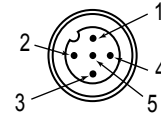

## Chapter Contents

Install the Software .....	11
Connect to the Sensor.....	11
Software Overview .....	12

## Chapter 3 Getting Started

Power up the sensor, and verify that the power LED is ON green.

### Install the Software

**IMPORTANT:** Administrative rights are required to install the Banner Radar Configuration software.

1. Download the latest version of the software from [www.bannerengineering.com/us/en/products/sensors/software/radar-configuration.html](http://www.bannerengineering.com/us/en/products/sensors/software/radar-configuration.html).
2. Navigate to and open the downloaded file.
3. Click **Install** to begin the installation process.
4. Depending on your system settings, a popup window may appear prompting to allow Banner Radar Configuration to make changes to your computer. Click **Yes**.
5. Click **Close** to exit the installer.

### Connect to the Sensor

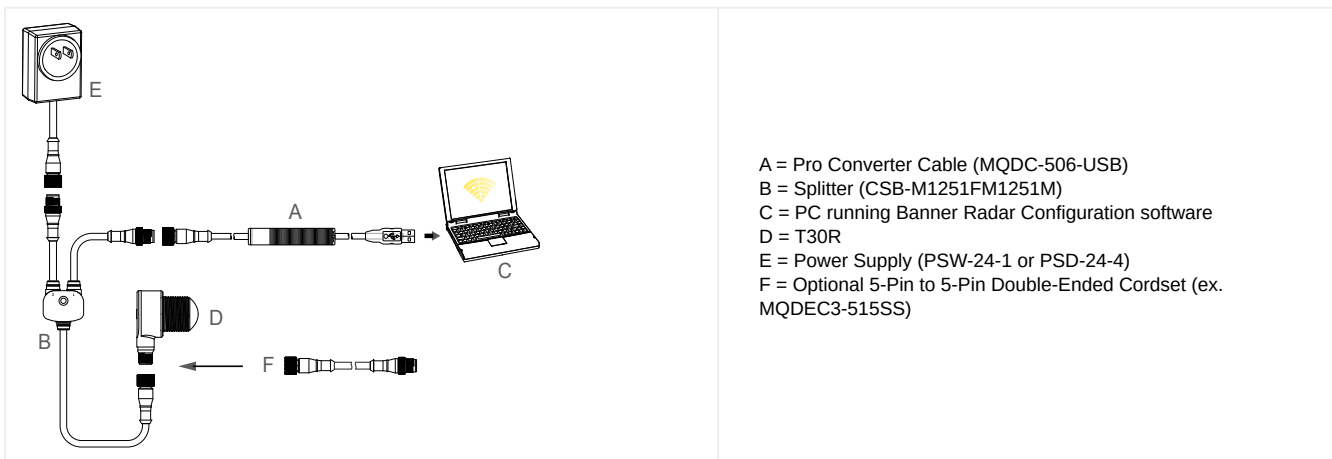

1. Connect the sensor to the splitter cable from the PRO-KIT. See "[Configuration Tool](#)" on page 39.
2. Connect the external power and Pro Converter cable to the splitter cable.
3. Connect the Pro Converter cable to the PC.
4. Open the Banner Radar Configuration Software.
5. Go to **Sensor > Connect** on the **Navigation** toolbar.  
The **Connection** screen displays.

6. Select the correct **Sensor Model** and **Com Port** for the sensor.
  7. Click **Connect**.
- The **Connection** screen closes and the sensor data displays.

## Software Overview

Easy setup and configuration of range, sensitivity, and output using the Banner Radar Configuration software and Pro Converter Cable.

*Banner Radar Configuration Software*

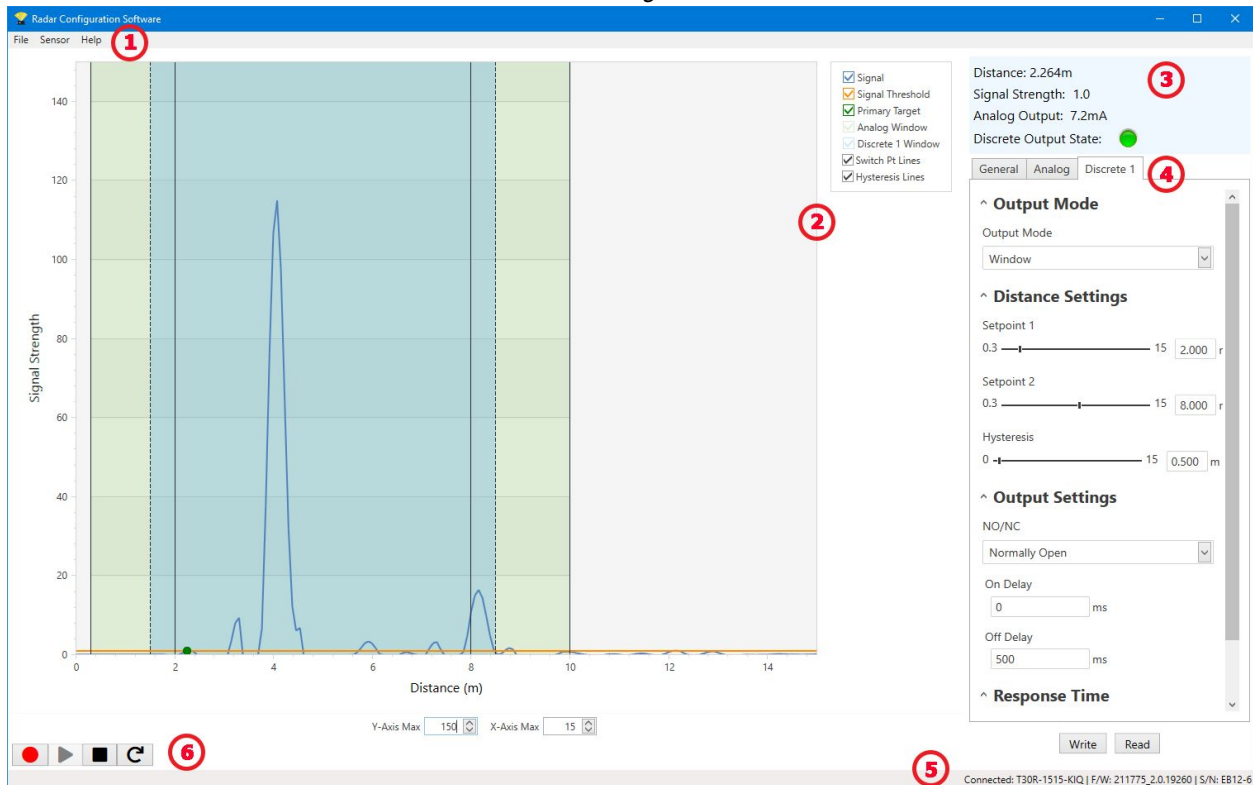

1. Navigation toolbar—Use this toolbar to connect to the sensor, to save or load a configuration, or to reset to factory defaults
2. Live Sensor Data and Legend—Shows the signal strength versus distance for the connected sensor, as well as options to select which data displays on the graph
3. Summary pane—Displays the distance to the target, the signal strength, and the output status
4. Sensor Settings pane—Set the sensor parameters in this pane
5. Status bar—Shows whether the sensor is connected, if a software update is available, and if the sensor data is being recorded to a file
6. Live Sensor Data controls—Use these controls to record, freeze, and play real-time sensor data, and to refresh the sensor connection

## Chapter Contents

Navigation Toolbar .....	13
Live Sensor Data and Legend .....	13
Summary Pane .....	14
Sensor Settings Pane.....	14
Live Sensor Data Controls .....	17

## Chapter 4      Banner Radar Configuration Workspace

---

### Navigation Toolbar

Use this toolbar to connect to the sensor, to save or load a configuration, or to reset to factory defaults.

**From the File menu, the following options are available:**

#### Load Config

Load a configuration to the connected sensor. Use this option to set up multiple sensors with the same parameters.

#### Save Config

Save a configuration to a desired location for future use.

#### Reset Frequently Used Settings

Resets the software settings without changing the configuration of the attached sensor.

#### Exit

Exit the Banner Radar Configuration Software.

**From the Sensor menu, the following options are available:**

#### Connect

Connect to the sensor.

#### Disconnect

Disconnect from the sensor.

#### Factory Reset

Select to perform a factor reset on the sensor. All custom parameters will be lost.

**From the Help menu, the following option is available:**

#### About

Select to view the software version number, the copyright notice, and the warranty.

### Live Sensor Data and Legend

The Live Sensor Data area displays the live distance and amplitude signal from the connected radar sensor. The signal strength threshold, switch point, and hysteresis are also plotted. Use these signals to evaluate targets to determine where the signal strength threshold and switch point should be configured for reliable detection.

Use the **Y-Axis Max** and the **X-Axis Max** to adjust the range displayed on the plot.

**Legend** -- Use the legend to select which data appears on the graph.

### Signal

Displays the strength of the signal over distance.

### Signal Threshold

Displays the signal strength threshold.

### Primary Targets

Represents the signal strength and location of the strongest target inside the switch point.

### Analog Window

The range the analog signal represents.

Available on analog models.

Varies by output model.

### Discrete 1/2 Window

The range for the discrete output.

Varies by output model.

### Switch Pt Lines

Displays the switch point distance.

### Hysteresis Lines

Displays the hysteresis distance.

## Summary Pane

The **Summary** pane (blue shaded area) displays **Distance**, **Signal Strength**, and **Output Status**.

### Distance

Displays the distance to the target.

### Signal Strength

Displays the amount of excess gain of the signal received from the target. The excess gain is relative to the minimum detection threshold (Signal Strength Threshold = 1).

### Output Status

Displays whether the output is ON or OFF, or the analog output value (analog models only).

## Sensor Settings Pane

Set parameters for the sensor.

Click **Read** to read the connected sensor's current parameters. Click **Write** to write the parameters to the sensor. Yellow highlight on a parameter's value indicates changes that have not yet been written to the sensor.

### General Tab

The following are the parameters on the **General** tab on the **Sensor Settings** pane.

#### Response Speed

Choose the response speed of the sensor (Slow, Medium, Fast).

#### Target Selection

**Signal Strength Threshold:** Choose the threshold for the minimum amount of signal needed to actuate the output.

#### Target Mode:

**Strongest Target**—Output responds to the target with the highest signal strength that is over the signal strength threshold.

**Nearest Target**—Output responds to the nearest target that is over the signal strength threshold.

## Advanced Target

**Minimum Active Sensing Range:** Sensor ignores anything from the face of the sensor to this defined range.

**Maximum Active Sensing Range:** Sensor ignores anything past this defined range.

**Measurement Hold:** A rate of change filter to smooth the output and reduce chatter. For more information, see "Using Measurement Hold Example" on page 27.

**Hold Time:** The period of time the sensor holds its last measurement and output status if the measurement changes more than the **Maximum Distance Increase** or the **Maximum Distance Decrease**. Available when **Measurement Hold** is set to enabled.

**Maximum Distance Increase:** The allowed limit the measurement can increase, or move farther away from the sensor, before initiating the **Measurement Hold**. Setting this to zero disables it. Available when **Measurement Hold** is set to enabled.

**Maximum Distance Decrease:** The allowed limit the measurement can decrease, or move closer to the sensor, before initiating the **Measurement Hold**. Setting this to zero disables it. Available when **Measurement Hold** is set to enabled.

## Sensor Polarity

Define the output and remote input signal type.

## Sensor Lockout

**Remote Input (Gray Wire):** Enable or disable the remote input wire.

**Sensor Push Buttons:** Enable or disable the push buttons.

## Analog Tab

The following are the parameters on the **Analog** tab on the **Sensor Settings** pane. This tab is available for analog models.

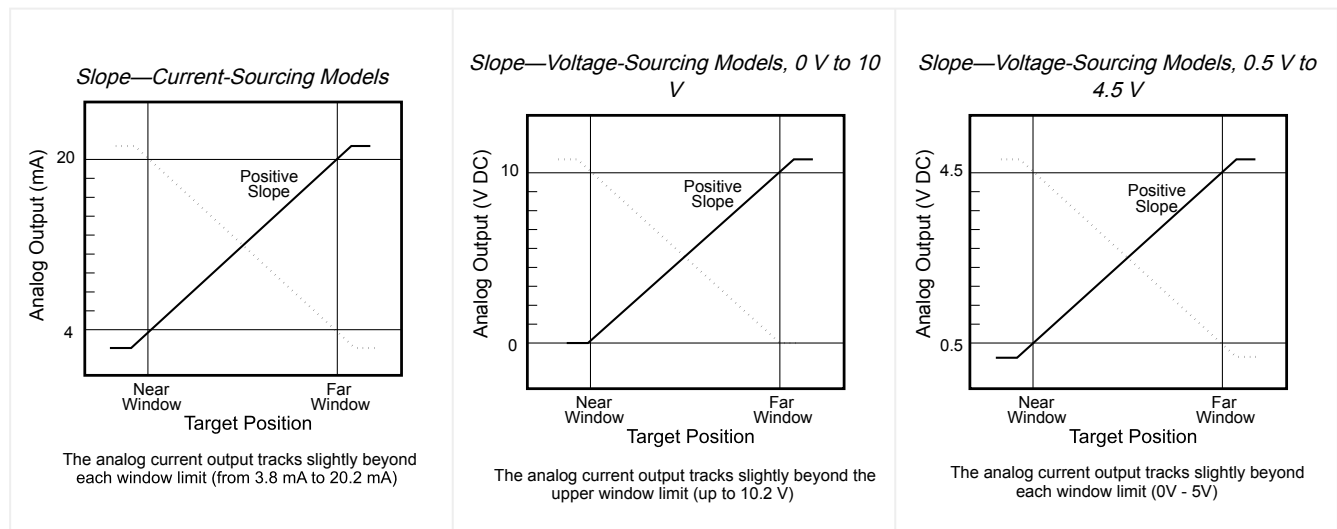

## Analog Span

Define the outer limits of the analog range. This can be used to create a positive or negative slope.

Analog output options:

Current: 4 mA to 20 mA

Voltage: 0 V to 10 V or 0.5 V to 4.5 V

## Output

**Loss-of-Signal:** Sets the Analog Output value used by the sensor during a loss of signal. When a signal is restored, measurement resumes.

**Hold Last Value—**The Analog Output holds the last value indefinitely during a loss of signal.

**3.5 mA (0 V)—**The Analog Output switches to this value 2 seconds after a loss of signal. For Voltage models, this is 0 V. (Default)

**20.5 mA (10.5 V/5 V)—**The Analog Output switches to this value 2 seconds after a loss of signal. For Voltage models, this is 10.5 V.

**Averaging:** Use this menu to set the number of measurements that are averaged together for the analog output. Increasing the averaging improves repeatability but increases the total response speed. The default is 1. The filter can be set to 1, 2, 4, 8, 16, 32, 64, or 128. The total response time is show under Response Time.

## Response Time

Calculates the total response time, taking into account the general response speed and averaging.

*Analog*

Response Speed	Analog Output Filter Setting							
	1	2	4	8	16	32	64	128
	Analog Output Spec (ms)							
Fast	2	4	8	16	32	64	128	256
Medium	20	40	80	160	320	640	1280	2560
Slow	100	200	400	800	1600	3200	6400	12500

## Discrete 1 Tab

The following are the parameters on the **Discrete 1** tab on the **Sensor Settings** pane.

### Output Mode

Select **Switch Point** or **Window**.

**Switch Point:** The distance at which the switch point threshold is placed.

**Window:** Define two set points to create window limits.

### Distance Settings

Define the set point(s) and the hysteresis.

### Output Settings

**NO/NC:** Select **Normally Open** or **Normally Closed** from the list.

**On Delay:** Set an on delay in milliseconds. The maximum time is 60,000 ms.

**Off Delay:** Set an off delay in milliseconds. The maximum time is 60,000 ms.

### Response Time

Calculates the total response time, taking into account the general response speed and on or off delays.

*Discrete*

Response Speed	Discrete Output ON Spec (ms)	Discrete Output OFF Spec (ms)
Fast	6	6
Medium	50	100
Slow	200	500

## Discrete 2 Tab

The following are the parameters on the **Discrete 2** tab on the **Sensor Settings** pane. This tab is available for dual discrete models.

### Output Mode

Select **Switch Point**, **Window**, **Complementary**, or **Pulse Pro/PFM**.

**Switch Point:** Set a single switch point for the output to change.

**Window:** Define two setpoints to create window limits.

**Complementary:** Output 2 will be the opposite of Output 1.

**Pulse Pro/PFM:** Pulse Pro/PFM output to interface with Banner lights or a PLC with PFM inputs.

### Distance Settings

Available when Output Mode is set to **Switch Point** or **Window**.

Define the set point(s) and the hysteresis.



## Output Settings

Available when Output Mode is set to **Switch Point** or **Window**.

**NO/NC:** Select **Normally Open** or **Normally Closed** from the list.

**On Delay:** Set an on delay in milliseconds. The maximum time is 60,000 ms.

**Off Delay:** Set an off delay in milliseconds. The maximum time is 60,000 ms.

## Response Time

Calculates the total response time, taking into account the general response speed and on or off delays.

*Discrete*

Response Speed	Discrete Output ON Spec (ms)	Discrete Output OFF Spec (ms)
Fast	6	6
Medium	50	100
Slow	200	500

## Pulse Pro/PFM Settings

Available when Output Mode is set to **Pulse Pro/PFM**.

The T30R can generate pulses whose frequency are proportional to the sensor's measured distance, thereby providing a method for representing an analog signal with only a discrete counter. The sensing range of the sensor is scaled from 100 Hz to 600 Hz. 100 Hz equals the near range limit of the sensor, and 600 Hz equals the far sensing range limit. An output of 50 Hz or 650 Hz (user defined in the software) represents a loss of signal condition where there is no target or the target is out of range. This output can be tied directly to a number of Banner lights for visual feedback without the need for a controller.

**100 Hz:** Define the near sensing range limit of the Pulse Pro range.

**600 Hz:** Define the far sensing range limit of the Pulse Pro range.

**Loss-of-Signal:** Sets the value used by the sensor during a loss of signal. When a signal is restored, measurement resumes.

Hold last value—The Discrete 2 Output holds the last value indefinitely during a loss of signal.

50 Hz—The Discrete 2 Output switches to this value 2 seconds after a loss of signal.

650 Hz—The Discrete 2 Output switches to this value 2 seconds after a loss of signal.

## Live Sensor Data Controls

After connecting to the sensor, data sampling begins automatically (but not recording).

To stop data sampling, click  **Stop**.

To restart data sampling, click  **Play**. This only samples data from the sensor and displays it on the plot; it does not record the data to a log file.

To record data to a log file, click  **Record**. The log file selection prompt displays. Save the log file as desired. The log file format is .csv.

If communication to the sensor is lost, click  **Refresh Device Connection** to reconnect.

*Blank page*

## Chapter Contents

Banner Radar Configuration Software .....	19
IO-Link Interface .....	19
Remote Input .....	19
Push Button Configuration .....	25
Reset the Sensor to Factory Defaults .....	25
Using Measurement Hold Example .....	27

## Chapter 5 Configuring a Sensor

### Banner Radar Configuration Software

Use the Banner Radar Configuration software and PRO-KIT to set up the R-GAGE sensor.

For more information visit [www.bannerengineering.com/us/en/products/sensors/software/radar-configuration.html](http://www.bannerengineering.com/us/en/products/sensors/software/radar-configuration.html).

### IO-Link Interface

IO-Link is a point-to-point communication link between a master device and sensor. Use IO-Link to parameterize sensors and transmit process data automatically.

For the latest IO-Link protocol and specifications, see [www.io-link.com](http://www.io-link.com).

Each IO-Link device has an IODD (IO Device Description) file that contains information about the manufacturer, article number, functionality etc. This information can be easily read and processed by the user. Each device can be unambiguously identified via the IODD as well as via an internal device ID. Download the T30R's IO-Link IODD package (p/n 216168 for analog models and p/n 217271 for dual discrete models) from Banner Engineering's website at [www.bannerengineering.com](http://www.bannerengineering.com).

Banner has also developed Add On Instruction (AOI) files to simplify ease-of-use between the T30R, multiple third-party vendors' IO-Link masters, and the Logix Designer software package for Rockwell Automation PLCs. Three types of AOI files for Rockwell Allen-Bradley PLCs are listed below. These files and more information can be found at [www.bannerengineering.com](http://www.bannerengineering.com).

**Process Data AOIs**—These files can be used alone, without the need for any other IO-Link AOIs. The job of a Process Data AOI is to intelligently parse out the Process Data word(s) in separate pieces of information. All that is required to make use of this AOI is an EtherNet/IP connection to the IO-Link Master and knowledge of where the Process Data registers are located for each port.

**Parameter Data AOIs**—These files require the use of an associated IO-Link Master AOI. The job of a Parameter Data AOI, when working in conjunction with the IO-Link Master AOI, is to provide quasi-realtime read/write access to all IO-Link parameter data in the sensor. Each Parameter Data AOI is specific to a given sensor or device.

**IO-Link Master AOIs**—These files require the use of one or more associated Parameter Data AOIs. The job of an IO-Link Master AOI is to translate the desired IO-Link read/write requests, made by the Parameter Data AOI, into the format a specific IO-Link Master requires. Each IO-Link Master AOI is customized for a given brand of IO-Link Master.

Add and configure the relevant Banner IO-Link Master AOI in your ladder logic program first; then add and configure Banner IO-Link Device AOIs as desired, linking them to the Master AOI as shown in the relevant AOI documentation.

### Remote Input

Use the remote input to program the sensor remotely.

The remote input provides limited programming options and is Active High. This can be configured for Active Low in the Banner Radar Configuration software by changing the **Sensor Polarity**. For Active High, connect the gray input wire to V+ (10 V

DC to 30 V DC), with a remote switch connected between the wire and V+. For Active Low, connect the gray input wire to ground (0 V DC) with a remote switch connected between the wire and ground.

The remote input wire is disabled by default. Pulse the remote input wire 10 times or use the Banner Radar Configuration software to enable the feature. After enabling the remote input feature, pulse the remote input according to the diagram and the instructions provided in this manual. Remote teach can also be performed using the button on the Pro Converter Cable.

The length of the individual programming pulses is equal to the value T: **0.04 seconds  $\leq$  T  $\leq$  0.8 seconds**.

Exit remote programming modes by setting the remote input Low for longer than 2 seconds or by waiting for 60 seconds.

Remote Input Map

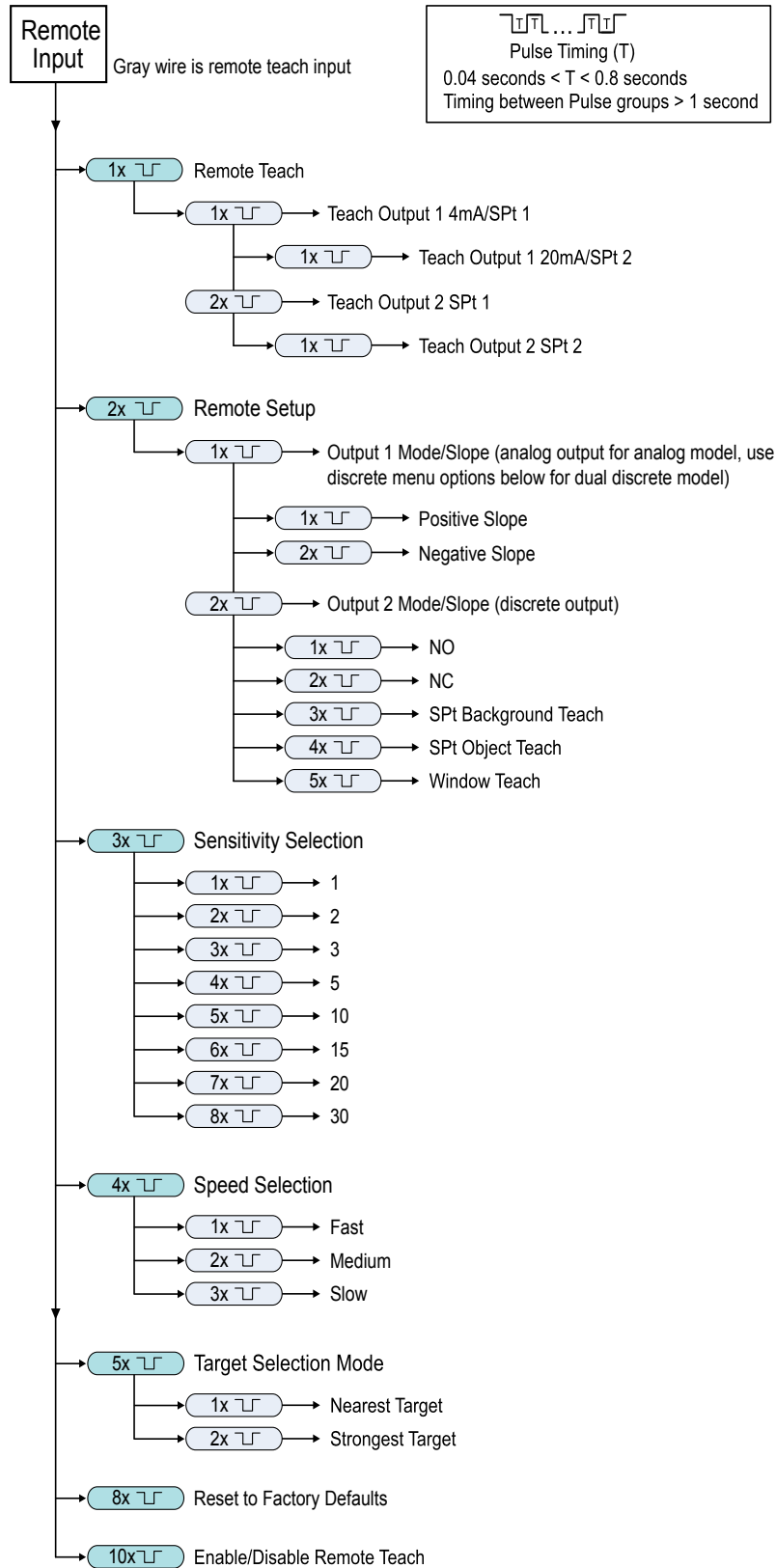

**NOTE:** If a factory reset is performed through the Banner Radar Configuration Software, the remote input wire becomes disabled (factory default setting). If the sensor is returned to factory defaults by using the remote input wire, the input wire remains enabled and the rest of the settings are restored to factory defaults.

## Remote Teach

Use the following procedure to teach the first and second switch points.

1. Pulse the remote input once. The green Power LED flashes, the amber LED is off, and the red LED is off.
2. Present the first point.
3. Teach the switch point.

Action		Result
Single-pulse the remote input.		<p><b>Teach Accepted</b></p> <p>The green Power LED is off, the yellow LED of the output being taught flashes while the yellow LED of the output not being taught is off. The red LED indicates signal strength.</p> <p><b>Teach Not Accepted</b></p> <p>The green Power LED continues to flash, the yellow LED is off, and the red LED is off.</p> <p>Retry teaching the first point.</p>

4. Present the second point.
5. Teach the switch point.

Action		Result
Single-pulse the remote input.		<p>The green Power LED turns on.</p> <p><b>Teach Accepted</b></p> <p>The sensor returns to run mode.</p> <p><b>Teach Not Accepted</b></p> <p>The green Power LED remains off, the yellow LED of the output being taught continues to flash while the yellow LED of the output not being taught is off.</p> <p>Retry teaching the second point.</p>

## Remote Setup

Use Remote Setup to set the output mode to set normally open or normally closed, change the analog slope, or set the teach mode.

While in remote set up, pulsing the remote wire once configures output 1. For analog models, the slope of the output changes. For discrete output, output 1 and output 2 options are identical.

Changing the Output Mode using remote input affects both the output configuration (normally open versus normally closed) and the Teach mode. The output configuration change takes effect immediately and can be used to change the output between normally open and normally closed or the analog slope without changing the switch point distance. The change in Teach mode does not immediately change the switch point location, but will affect the behavior of the next remote Teach.

### Analog Teach Modes

The default is to teach two separate points. With a positive slope, the first taught point is 4 mA and the second taught point is 20 mA.

If the two taught points are within 100 mm or less, the sensor views them as the same point. It considers that point as the 20 mA spot and sets the 4 mA spot at 300 mm. If a taught point is within the dead zone, the sensor sets that point at 300 mm.

### Discrete Teach Modes

Teaching two separate points creates a window around that range.

Background Teach—Teaching the same point twice (points within 100 mm of each other) sets the switch point 200 mm in front of the taught point.

Object Teach—Teaching the same point twice (points within 100 mm of each other) sets the switch point 100 mm behind the taught point.

Window Teach—Teaching the same point twice (points within 100 mm of each other) sets a window  $\pm 50$  mm on either side of the taught point, for a total window size of 100 mm.







### Set the Sensitivity

Use Sensitivity Selection to set the signal strength threshold.

1. Access Sensitivity Selection.

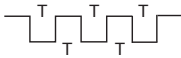
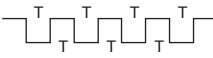
Action		Result
Triple-pulse the remote input.		The green power LED flashes slowly.

2. Select the desired signal threshold.

Action		Result
Pulses		TEACH Mode
1		Signal Strength Threshold = 1
2		Signal Strength Threshold = 2
3		Signal Strength Threshold = 3
4		Signal Strength Threshold = 5
5		Signal Strength Threshold = 10
6		Signal Strength Threshold = 15
7		Signal Strength Threshold = 20

The signal threshold is set and the green power LED flashes equal to the number of pluses, pauses, and then flashes equal to the number of pulses a second time. Then the sensor exits remote teach and returns to run mode.

Continued on page 24

Continued from page 23

Action		TEACH Mode	Result
Pulses			
8		Signal Strength Threshold = 30	



### Set the Speed

Use Speed Selection to set the speed of the sensor.

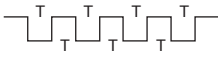
1. Access Speed Selection.

Action		Result
Four-pulse the remote input.		The green power LED flashes slowly.

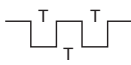
2. Select the desired signal threshold.

Action		TEACH Mode	Result
Pulses			
1		Speed = Fast	The speed is set and the power LED flashes equal to the number of pluses, pauses, and then flashes equal to the number of pulses a second time. The sensor exits remote teach and returns to run mode.
2		Speed = Medium	
3		Speed = Slow	



### Target Selection Mode

Use Target Selection to set the target that the output sees.

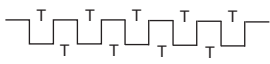
1. Access Target Selection mode.

Action		Result
Five-pulse the remote input.		The green power LED flashes slowly.

2. Select the desired signal threshold.

Action		TEACH Mode	Result
Pulses			
1		Nearest Target—Output responds to the nearest target that is over the signal strength threshold.	The signal threshold is set and the green power LED flashes equal to the number of pluses, pauses, and then flashes equal to the number of pulses a second time. Then the sensor exits remote teach and returns to run mode
2		Strongest Target—Output responds to the target with the highest signal strength that is over the signal strength threshold.	



## Push Button Configuration

Using the push buttons, the first and second points can be taught.

This can be done by teaching two separate points or the same point twice. For more information on the Teach modes, see "[Remote Setup](#)" on page 22. If other changes to the configuration are needed, use either the Banner Radar Configuration Software or the remote input.

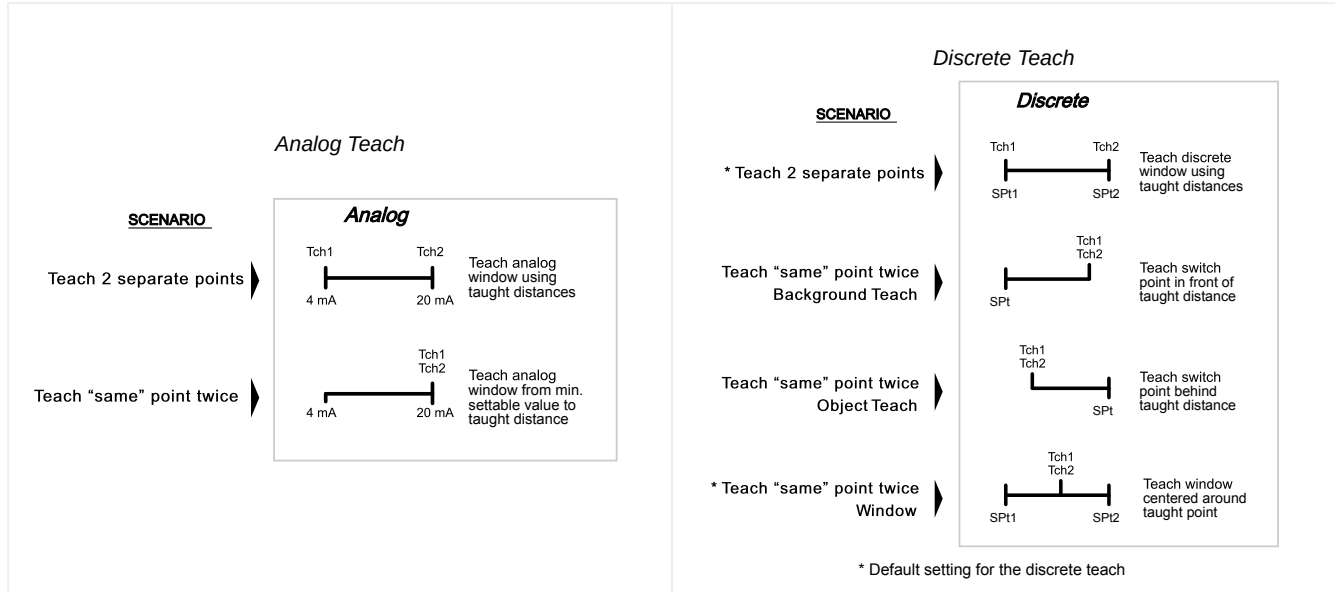

The TEACH modes must be set with the remote input wire.

To cancel a configuration while in process, press and hold the button for the output being taught for longer than 2 seconds.

1. To enter TEACH mode, press and hold the button for the desired output.

The buttons are **Analog** and **Discrete** (analog models) and **Discrete 1** and **Discrete 2** (discrete models).

The green Power LED turns OFF, the yellow LED of the output being taught turns ON, and the yellow LED of the output not being taught turns OFF.

2. Position the target.
3. Press the button for the desired output one time to configure the first point.  
The yellow LED of the output being taught flashes.
4. Position the target.
5. Press the button for the desired output one time to configure the second point.  
The green Power LED turns on.

## Reset the Sensor to Factory Defaults

Reset the sensor to factory default settings using one of two methods.

**NOTE:** If a factory reset is performed through the Banner Radar Configuration Software, the remote input wire becomes disabled (factory default setting). If the sensor is returned to factory defaults by using the remote input wire, the input wire remains enabled and the rest of the settings are restored to factory defaults.

To reset using the Banner Radar Configuration software, go to **Sensor > Factory Reset**. The sensor indicators flash once, the sensor is reset back to the factory default settings, and a confirmation message displays.

To reset using the remote input, eight-pulse the remote input to apply the factory defaults.

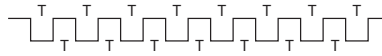

## Factory Default Settings

### General Tab Default Settings

Setting	Factory Default
Response Speed	Medium
Signal Strength Threshold	1.0
Target Mode	Nearest Target
Measurement Hold	Disabled
Discrete Output & Remote Input	PNP
Remote Input Wire	Disabled
Push Buttons	Enabled

### Analog Tab Default Settings

Setting	Factory Default			
	1515 Models	1515-C Models	1515-L Models	4545 Models
Range	4 mA to 20 mA (0 V to 10 V)	4 mA to 20 mA (0 V to 10 V)	4 mA to 20 mA (0 V to 10 V)	4 mA to 20 mA (0 V to 10 V)
4mA/0V Point	0.3 m (1 ft)	0.1 m (.33 ft)	0.3 m (1 ft)	0.3 m (1 ft)
20mA/10V Point	15.0 m (49.2 ft)	6 m (19.7 ft)	25.0 m (82 ft)	10 m (32.8 ft)
Loss of Signal	3.5 mA (0 V)	3.5 mA (0 V)	3.5 mA (0 V)	3.5 mA (0 V)
Averaging	1× (no averaging)	1× (no averaging)	1× (no averaging)	1× (no averaging)

### Discrete 1 Tab Default Settings

Setting	Factory Default			
	1515 Models	1515-C Models	1515-L Models	4545 Models
Output Mode	Switch Point	Switch Point	Switch Point	Switch Point
Setpoint 1	15.0 m (49.2 ft)	6 m (19.7 ft)	25.0 m (82 ft)	10 m (32.8 ft)
Hysteresis	0.05 m (2 in)	0.05 m (2 in)	0.05 m (2 in)	0.05 m (2 in)
NO/NC	Normally Open	Normally Open	Normally Open	Normally Open
On Delay	0 ms	0 ms	0 ms	0 ms
Off Delay	500 ms	500 ms	500 ms	500 ms

### Discrete 2 Tab Default Settings

Setting	Factory Default			
	1515 Models	1515-C Models	1515-L Models	4545 Models
Output Mode	Switch Point	Switch Point	Switch Point	Switch Point

Continued on page 27

Continued from page 26

Setting	Factory Default			
	1515 Models	1515-C Models	1515-L Models	4545 Models
Setpoint 1	15.0 m (49.2 ft)	6 m (19.7 ft)	25.0 m (82 ft)	10 m (32.8 ft)
Hysteresis	0.05 m (2 in)	0.05 m (2 in)	0.05 m (2 in)	0.05 m (2 in)
NO/NC	Normally Open	Normally Open	Normally Open	Normally Open
On Delay	0 ms	0 ms	0 ms	0 ms
Off Delay	500 ms	500 ms	500 ms	500 ms

## Using Measurement Hold Example

Measurement Hold (The hold time is set to 1 second)

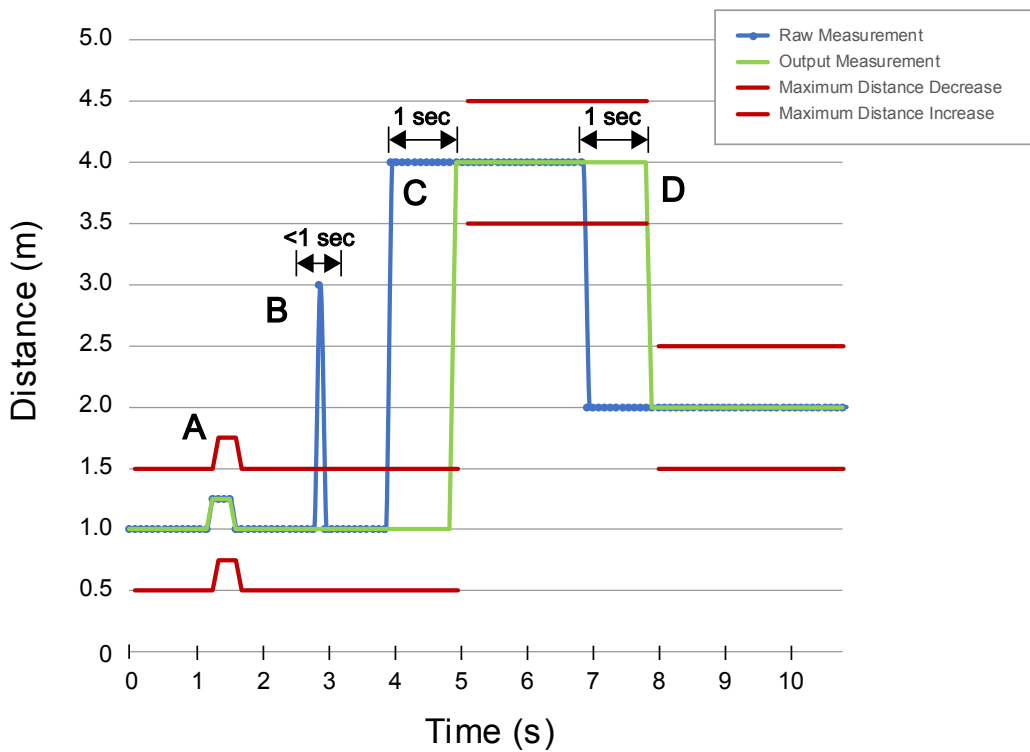

A.	The Max Distance Change threshold (red lines) adapts based on the previous Raw Measurement sample (blue lines) as long as that sample was within the previous thresholds.
B.	The temporary distance spike in the Raw Measurement (blue lines) is filtered out because the distance increase was outside of the Max Distance Change (red lines). The Output Measurement (green lines) will hold its last measurement.
C.	The Raw Measurement change (blue lines) is greater than the Max Distance Change (red lines) so the Output Measurement (green lines) holds its previous value while the Raw Measurement is beyond the Max Distance Change. After the 1 second Hold Time expires, the Output Measurement and Max Distance Change thresholds are updated based on the next Raw Measurement value.

Continued on page 28

Continued from page 27

D.	The Raw Measurement (blue lines) drops down to a value below the Max Distance Change (red lines) so the Output Measurement (green lines) holds its value for the Hold Time. After the 1 second Hold Time expires, the Output Measurement and Max Distance Change thresholds are updated based on the next Raw Measurement value.
----	--

Chapter Contents

FCC Part 15 Class A ..... 30  
 Industry Canada Statement for Intentional Radiators ..... 30  
 PC Requirements ..... 31  
 T30R Dimensions ..... 31  
 Beam Patterns ..... 32

# Chapter 6 T30R Specifications

**Range**

The sensor can detect an object at the following ranges, depending on the material of the target:

- T30R-1515 models:  
 Detection Range: 0.15 m to 15 m (0.5 ft to 49.2 ft)  
 Measurement Range: 0.2 m to 15 m (0.7 ft to 49.2 ft)
- T30R-1515-C models:  
 Detection Range: 0.1 m to 6 m (0.33 ft to 19.7 ft)  
 Measurement Range: 0.1 m to 6 m (0.33 ft to 19.7 ft)
- T30R-1515-L models:  
 Detection Range: 0.15 m to 25 m (0.5 ft to 82 ft)  
 Measurement Range: 0.2 m to 25 m (0.7 ft to 82 ft)
- T30R-4545 models:  
 Detection Range: 0.3 m to 10 m (1.0 ft to 32.8 ft)  
 Measurement Range: 0.3 m to 10 m (1.0 ft to 32.8 ft)

**Operating Principle**

Frequency modulated continuous-wave (FMCW) radar

**Operating Frequency**

122 GHz

**Frequency Range**

- T30R-1515 and T30R-4545: 122 GHz to 123 GHz
- T30R-1515-C: 120.5 GHz to 123 GHz

**Supply Voltage (Vcc)**

- Analog Voltage models:** 12 V DC to 30 V DC
- Analog Current and Dual Discrete models:** 10 V DC to 30 V DC
- Use only with a suitable Class 2 power supply (UL) or Limited Power Supply (CE)

**Power and Current Consumption, exclusive of load**

- Power consumption:** < 2.4 W
- Current consumption:** < 100 mA at 24 V DC

**Delay at Power-up**

< 300 ms

**Supply Protection Circuitry**

Protected against reverse polarity and transient overvoltages

**Linearity<sup>(1)</sup>**

- T30R-1515 and T30R-4545  
 <± 20 mm at < 500 mm  
 <± 4 mm at > 500 mm
- T30R-1515-C: < ± 4 mm

**Maximum Torque**

2.3 N·m (20 in-lbs)

**Repeatability<sup>(2)</sup>**

< 1 mm

<sup>(1)</sup> Reference target with RCS = 1m².

<sup>(2)</sup> Repeatability < 10 mm at Excess Gain < 10×.

**Maximum Output Power**

EIRP: 100 mW, 20 dBm

**Output Protection**

Protected against output short-circuit

**Remote Input**

- Allowable Input Voltage Range: 0 to Vsupply
- Active High (internal weak pull-down): High state > (Vsupply - 2.25 V) at 2 mA maximum
- Active Low (internal weak pull-up): Low state < 2.25 V at 2 mA maximum

**Response Time**

- Analog update rate: 2 ms
- Discrete output response: 6 ms
- Speeds given for fast mode.

**Indicators**

- Power LED:** Green, power on
- Signal Strength LED:**  
 Red Flash: weak signal  
 Red Solid: 4× threshold
- Output LEDs:** Amber, target within taught analog span/discrete output status
- NO/NC LED:** Amber, normally open/normally closed status of discrete output
- See "T30R Features" on page 7

**Construction**

- Housing:** PBT
- Window:** COP

**Output Configuration**

- Analog Outputs:
- **Current models**  
 Discrete Output (Black Wire): IO-Link, push/pull output, configurable PNP or NPN output  
 Analog output (White Wire): 4 mA to 20 mA
- **Voltage models**  
 Discrete Output (Black Wire): IO-Link, push/pull output, configurable PNP or NPN output  
 Analog output (White Wire): Configurable 0 V to 10 V or 0.5 V to 4.5 V
- **Dual Discrete models**  
 Discrete Output 1 (Black Wire): IO-Link, push/pull output, configurable PNP or NPN output  
 Discrete Output 2 (White Wire): Configurable PNP or NPN, or Pulse Frequency Modulated (PFM) output

**Advanced Capabilities**



Available only in dual discrete models

**Connections**

Integral M12 quick disconnect (as listed in the models table) or 150 mm (6 in) PUR-jacketed cable with an M12 quick disconnect

Models with a quick disconnect require a mating cordset

**Vibration and Mechanical Shock**

All models meet MIL-STD-202F, Method 201A (Vibration: 10 Hz to 60 Hz maximum, 0.06 inch (1.52 mm) double amplitude, 10G acceleration) requirements. Method 213B conditions H&I.Shock: 75G with device operating; 100G for non-operation

**Operating Temperature**

-40 °C to +65 °C (-40 °F to +149 °F)

**Temperature Effect**

< ± 10 mm from -40 °C to +65 °C (-40 °F to +149 °F)

**Environmental Rating**

IP67

**Output Ratings**

Analog Outputs:

· **Current Output (T30R....-I.. models):** 1 kΩ maximum load resistance at 24 V; maximum load resistance =  $[(V_{cc} - 4.5)/0.02 \Omega]$

· **Voltage Output (T30R....-U.. models):** 2.5 kΩ minimum load resistance

Discrete Outputs:

· **Current rating = 50 mA maximum each**

Black wire specifications per configuration		
IO-Link Push/Pull	Output High	≥ Vsupply - 2.5 V
	Output Low	≤ 2.5V
PNP	Output High	≥ Vsupply - 2.5 V
	Output Low	≤ 1V (loads ≤ 1 MegΩ)
NPN	Output High	≥ Vsupply - 2.5 V
	Output Low	≤ 2.5 V

White wire specifications per configuration		
PNP	Output High	≥ Vsupply - 2.5 V
	Output Low	≤ 2.5 V (loads ≤ 70 kΩ)
NPN	Output High	≥ Vsupply - 2.5 V
	Output Low	≤ 2.5 V

**Certifications**



Banner Engineering BV  
Park Lane, Culliganlaan 2F bus 3  
1831 Diegem, BELGIUM



Turck Banner LTD Blenheim House  
Blenheim Court  
Wickford, Essex SS11 8YT  
GREAT BRITAIN



IND. CONT. EQ.  
E224071

UL Environmental Rating: Type 1

ETSI EN 305 550-1 V.1.2.1

ETSI EN 305 550-2 V.1.2.1

FCC Part 15, §15.258

FCC ID: UE3-T30R

IC ID: 7044A-T30R

for others, contact Banner Engineering

Country of Origin: USA

Operation of the T30R sensor on board an aircraft or a satellite shall be prohibited.

**FCC Part 15 Class A**

This equipment has been tested and found to comply with the limits for a Class A digital device, pursuant to part 15 of the FCC Rules. These limits are designed to provide reasonable protection against harmful interference when the equipment is operated in a commercial environment. This equipment generates, uses, and can radiate radio frequency energy and, if not installed and used in accordance with the instruction manual, may cause harmful interference to radio communications. Operation of this equipment in a residential area is likely to cause harmful interference in which case the user will be required to correct the interference at his own expense.

**Industry Canada Statement for Intentional Radiators**

This device contains licence-exempt transmitters(s)/receiver(s) that comply with Innovation, Science and Economic Development Canada's licence-exempt RSS(s). Operation is subject to the following two conditions:

1. This device may not cause interference.
2. This device must accept any interference, including interference that may cause undesired operation of the device.

Cet appareil contient des émetteurs/récepteurs exemptés de licence conformes à la norme Innovation, Sciences, et Développement économique Canada. L'exploitation est autorisée aux deux conditions suivantes:

1. L'appareil ne doit pas produire de brouillage.
2. L'utilisateur de l'appareil doit accepter tout brouillage radioélectrique subi, même si le brouillage est susceptible d'en compromettre le fonctionnement.

## PC Requirements

### Operating System

Microsoft® Windows® operating system version 10 or 11<sup>(1)</sup>

### Hard Drive Space

500 MB

<sup>(1)</sup> Microsoft and Windows are registered trademarks of Microsoft Corporation in the United States and/or other countries.

### Third-Party Software

.NET

### USB Port

Available USB port

**IMPORTANT:** Administrative rights are required to install the Banner Radar Configuration software.

## T30R Dimensions

All measurements are listed in millimeters [inches], unless noted otherwise.

### T30R-1515 Models

#### Integral QD Models

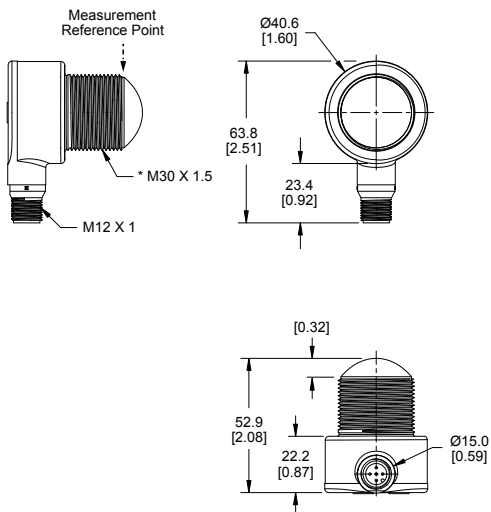

#### 150 mm QD Models

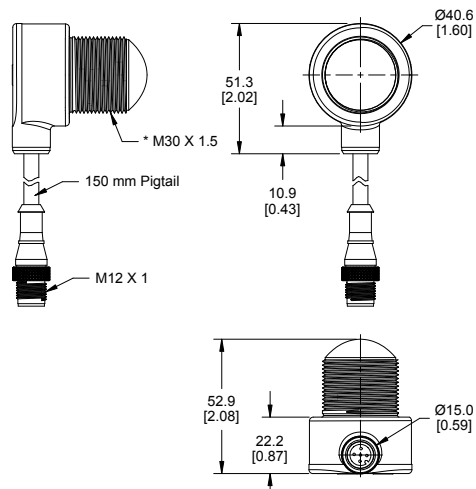

\* Max. Torque 2.3 Nm (20 in-lbs)

*T30R-4545 Models*

**Integral QD Models**

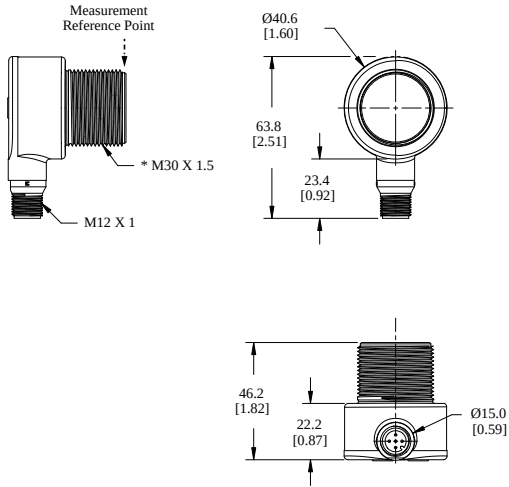

**150 mm QD Models**

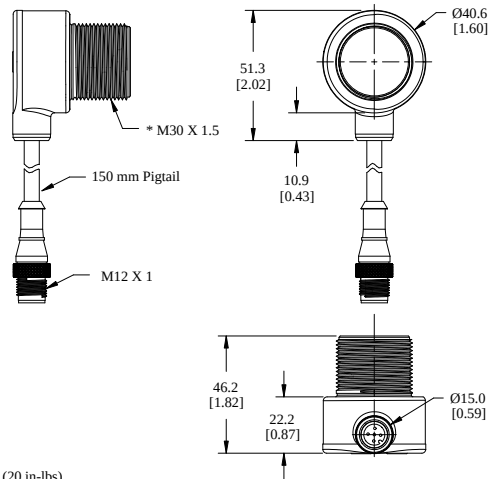

\* Max. Torque 2.3 Nm (20 in-lbs)

## Beam Patterns

The beam pattern of the radar sensor depends on the radar cross section (RCS) of the target.

The beam pattern graphs are guides for representative object detection capabilities based on different-sized radar cross-sections and corresponding example real-world targets. Use the following charts as a starting point in the application setup. Note that applications vary.

- Use the Beam Width versus Distance chart to understand where corresponding objects can be detected. Adjusting the signal strength threshold also affects the beam pattern when the target is constant.
- Use the Beam Width versus Degrees chart to help determine how much the target can tilt from 90 degrees while still maintaining detection.

Unless otherwise specified, the following beam patterns are shown with Signal Strength Threshold = 1.



T30R-1515 and T30R-1515-L Models<sup>(1)</sup>

Typical beam pattern, in meters, of T30R-1515 and T30R-1515-L on representative targets

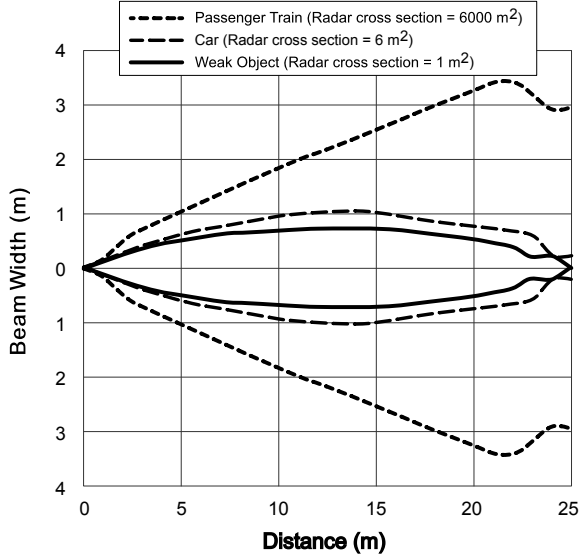

Typical beam pattern, in degrees, of T30R-1515 and T30R-1515-L on representative targets

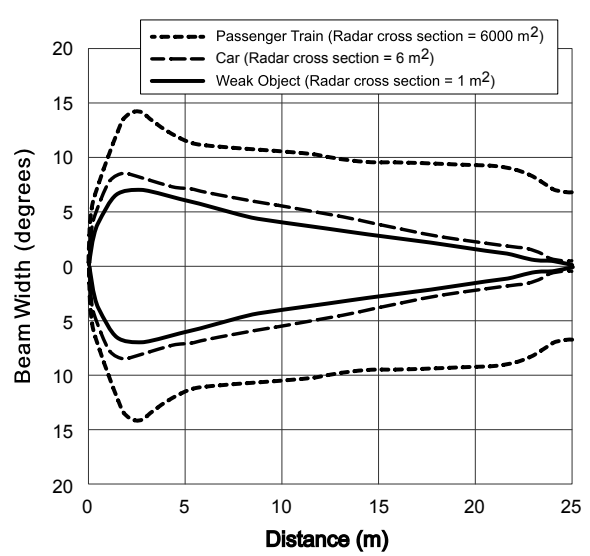

T30R-1515-C Near-Range Models

Typical beam pattern, in meters, of T30R-1515-C on representative targets

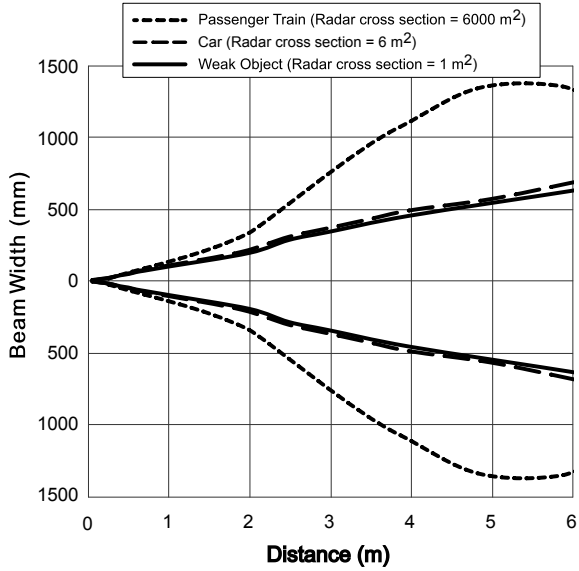

Typical beam pattern, in degrees, of T30R-1515-C on representative targets

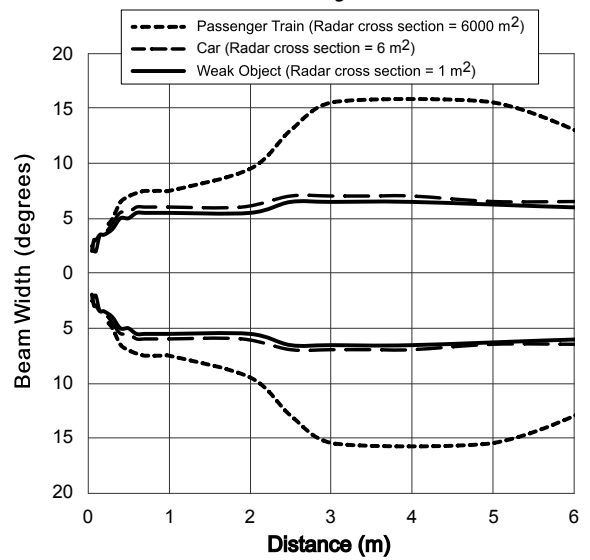

<sup>(1)</sup> The 15 m to 25 m region only applies to the T30R-1515-L model.

T30R-4545 Models<sup>(1)</sup>

Typical beam pattern, in meters, of T30R-4545 on representative targets

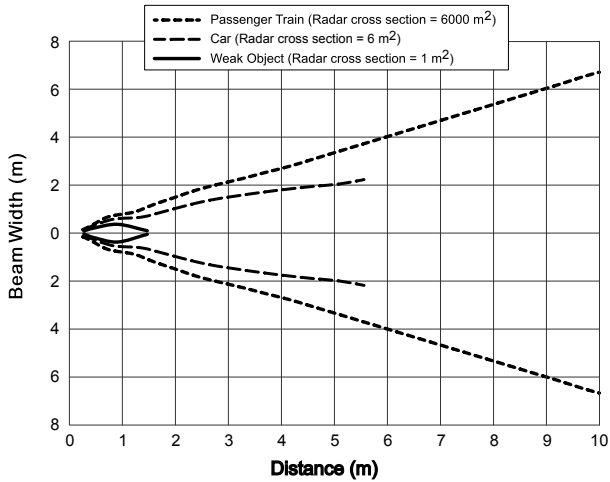

Typical beam pattern, in degrees, of T30R-4545 on representative targets

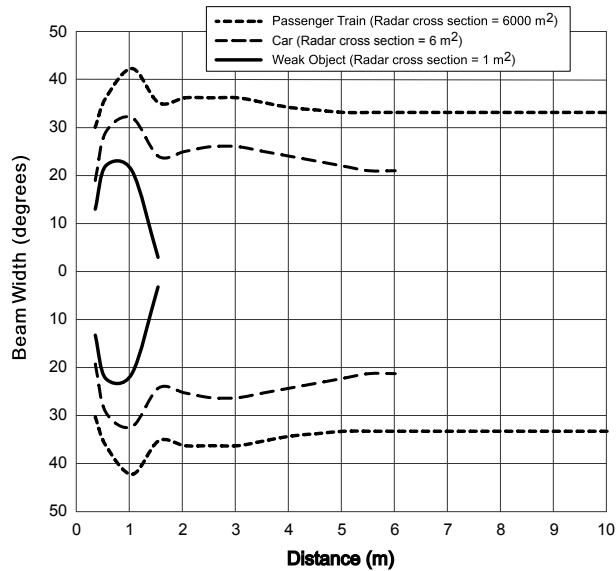

Typical Beam pattern, in meters, of T30R-4545 with fixed target and various Signal Strength Thresholds

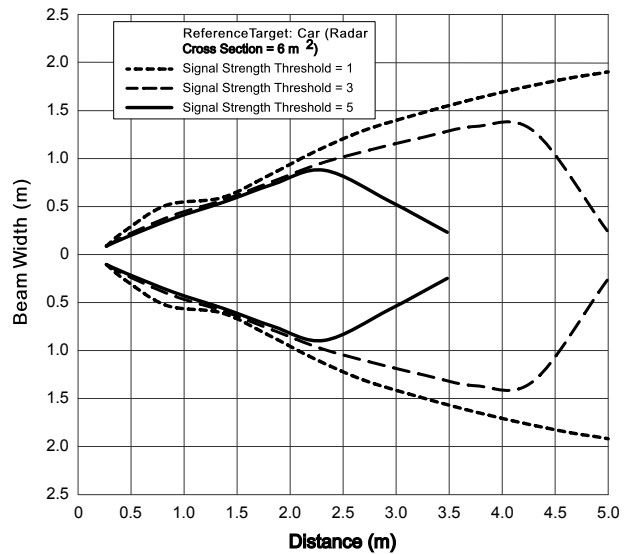



<sup>(1)</sup> For the most reliable detection, the target should be larger than half of the beam width.

## Chapter 7 Update the Software

Use this procedure to update the Banner Radar Configuration Software.

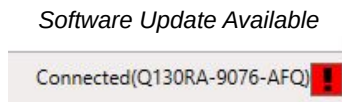
The Banner Radar Configuration Software automatically looks for updated software versions. The symbol  in the lower right corner indicates that a software update is available.



1. Click  in the lower right corner of the software.  
The Banner Radar Configuration Software Update screen displays.

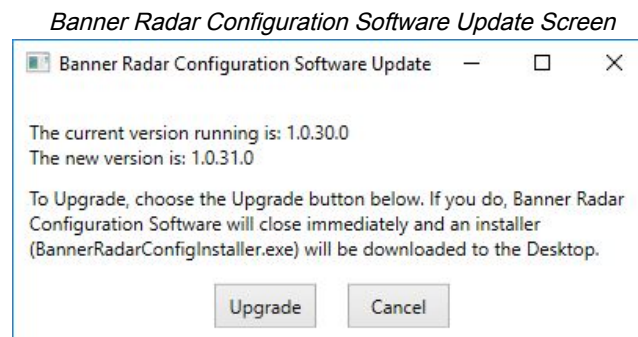

2. Click **Upgrade** to begin the process.  
The Banner Radar Configuration Software closes and an installer (BannerRadarConfigInstaller.exe) downloads to the desktop.

**NOTE:** If changes have not been written to the sensor, the system asks whether you want to exit the program. Click **No** to stop the update process and return to the Software. Write the changes to the sensor, then return to step 1, above, to update the Software.

3. Navigate to and open the file BannerRadarConfigInstaller.exe.
4. Depending on your system settings, a popup window may appear prompting to allow Banner Radar Configuration Software to make changes to your computer. Click **Yes**.
5. Click **Close** to exit the installer.

The software update is complete.

*Blank page*

Chapter Contents

Brackets ..... 37  
 Cordsets ..... 38  
 Configuration Tool ..... 39

# Chapter 8 Accessories

## Brackets

All measurements are in mm

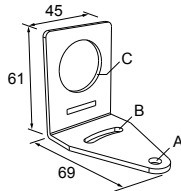
<p><b>SMB30A</b></p> <ul style="list-style-type: none"> <li>• Right-angle bracket with curved slot for versatile orientation</li> <li>• Clearance for M6 (¼ in) hardware</li> <li>• Mounting hole for 30 mm sensor</li> <li>• 12-ga. stainless steel</li> </ul>	
<p><b>Hole center spacing:</b> A to B=40  <b>Hole size:</b> A=ø 6.3, B= 27.1 x 6.3, C=ø 30.5</p>	

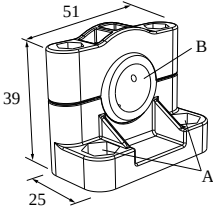
<p><b>SMB1815SF</b></p> <ul style="list-style-type: none"> <li>• Swivel with set screws for mounting sensors by the cable hub</li> <li>• Black reinforced thermoplastic polyester</li> <li>• Stainless steel swivel locking hardware and hex wrench included</li> </ul> <p><b>Hole center spacing:</b> A = 36.0 <b>Hole size:</b> A = ø 5.0, B = ø 15.0</p>	
---	---

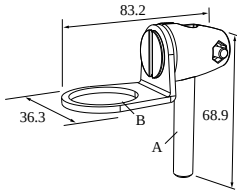
<p><b>SMB30FA</b></p> <ul style="list-style-type: none"> <li>• Swivel bracket with tilt and pan movement for precise adjustment</li> <li>• Mounting hole for 30 mm sensor</li> <li>• 12-ga. 304 stainless steel</li> <li>• Easy sensor mounting to extrude rail T-slot</li> <li>• Metric and inch size bolt available</li> </ul>	
<p><b>Bolt thread:</b> SMB30FA, A= 3/8 - 16 x 2 in; SMB30FAM10, A= M10 - 1.5 x 50      <b>Hole size:</b> B= ø 30.1</p>	

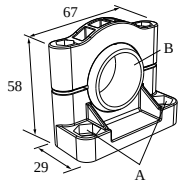
<p><b>SMB30SC</b></p> <ul style="list-style-type: none"> <li>• Swivel bracket with 30 mm mounting hole for sensor</li> <li>• Black reinforced thermoplastic polyester</li> <li>• Stainless steel mounting and swivel locking hardware included</li> </ul>	
---	---

Continued on page 38

Continued from page 37

**Hole center spacing:** A=∅ 50.8  
**Hole size:** A=∅ 7.0, B=∅ 30.0

**SMBT30RTM**

- Mount to a flat surface, such as a wall, with the sensor pointing up or down
- Mount on the top of a plastic tank to measure the level from outside the tank
- 12-ga. stainless steel

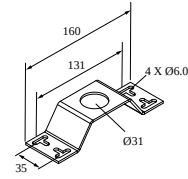

**SAFT30R-PVC-G2**

- M30 to 2-inch NPT adapter
- PVC threaded adapter
- 11-ga. stainless steel retainer ring

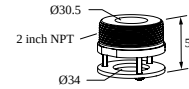

## Cordsets

**5-Pin Threaded M12 Cordsets with Shield—Single Ended**

Model	Length	Style	Dimensions	Pinout (Female)
MQDEC2-506	2 m (6.56 ft)	Straight		<p>1 = Brown                      2 = White                      3 = Blue                      4 = Black                      5 = Gray</p>
MQDEC2-515	5 m (16.4 ft)			
MQDEC2-530	9 m (29.5 ft)			
MQDEC2-550	15 m (49.2 ft)			
MQDEC2-575	23 m (75.44 ft)			
MQDEC2-5100	30.5 m (100 ft)			
MQDEC2-506RA	2 m (6.56 ft)	Right-Angle		
MQDEC2-515RA	5 m (16.4 ft)			
MQDEC2-530RA	9 m (29.5 ft)			
MQDEC2-550RA	15 m (49.2 ft)			
MQDEC2-575RA	23 m (75.44 ft)			
MQDEC2-5100RA	31 m (101.68 ft)			

**5-Pin Male Threaded and 5-Pin Female Quick Disconnect M12 Cordset with Shield—Double Ended**

Model	Length "L1"	Style	Pinout (Male)	Pinout (Female)
MQDEC3-503SS	0.91 m (2.99 ft)	Female Straight/Male Straight		
MQDEC3-506SS	1.83 m (6 ft)			
MQDEC3-515SS	4.58 m (15 ft)			
MQDEC3-530SS	9.2 m (30.2 ft)			

Continued on page 39

Continued from page 38

5-Pin Male Threaded and 5-Pin Female Quick Disconnect M12 Cordset with Shield—Double Ended				
Model	Length "L1"	Style	Pinout (Male)	Pinout (Female)
			<p>1 = Brown 2 = White 3 = Blue</p>	<p>4 = Black 5 = Gray</p>

5-Pin Threaded M12 Splitter Cordset with Flat Junction				
Model	Trunk (Male)	Branches (Female)	Pinout (Male)	Pinout (Female)
CSB-M1251M1251B	0.3 m (0.98 ft)	0.3 m (0.98 ft)		
			<p>1 = Brown 2 = White 3 = Blue</p>	<p>4 = Black 5 = Gray</p>

**NOTE:** The splitter in the PRO-KIT has two male and one female connectors. The CSB-M1251M1251B splitter has one male and two female connectors. Use the CSB-M1251M1251B to connect the sensor to power and a one of the Banner Pro lights with the Pulse Pro output.

## Configuration Tool

<p><b>PRO-KIT</b></p> <p>Includes:</p> <ul style="list-style-type: none"> <li>• Pro Converter Cable (MQDC-506-USB)</li> <li>• Splitter (CSB-M1251FM1251M)</li> <li>• Power Supply (PSW-24-1)</li> </ul>	
---	--

*Blank page*



## Chapter Contents

Repairs .....	41
Contact Us.....	41
Banner Engineering Corp. Software Copyright Notice.....	41
Banner Engineering Corp Limited Warranty .....	41
Document Information.....	42

## Chapter 9 Product Support and Maintenance

### Repairs

Contact Banner Engineering for troubleshooting of this device. **Do not attempt any repairs to this Banner device; it contains no field-replaceable parts or components.** If the device, device part, or device component is determined to be defective by a Banner Applications Engineer, they will advise you of Banner's RMA (Return Merchandise Authorization) procedure.

**IMPORTANT:** If instructed to return the device, pack it with care. Damage that occurs in return shipping is not covered by warranty.

You may be asked to provide the configuration file and the data log file (.cfg) to aid in troubleshooting.

### Contact Us

Banner Engineering Corp. headquarters is located at: 9714 Tenth Avenue North | Minneapolis, MN 55441, USA | Phone: + 1 888 373 6767

For worldwide locations and local representatives, visit [www.bannerengineering.com](http://www.bannerengineering.com).

### Banner Engineering Corp. Software Copyright Notice

© Banner Engineering Corp., All Rights Reserved.

<https://www.bannerengineering.com/us/en/company/terms-and-conditions.html>

**Disclaimer of Warranties.** This software is provided "AS-IS." To the maximum extent permitted by applicable law, Banner, its affiliates, and its channel partners disclaim all warranties, expressed or implied, including any warranty that the software is fit for a particular purpose, title, merchantability, data loss, non-interference with or non-infringement of any intellectual property rights, or the accuracy, reliability, quality or content in or linked to the services. Banner and its affiliates and channel partners do not warrant that the services are secure, free from bugs, viruses, interruption, errors, theft or destruction. If the exclusions for implied warranties do not apply to you, any implied warranties are limited to 60 days from the date of first use of this software.

**Limitation of Liability and Indemnity.** Banner, its affiliates and channel partners are not liable for indirect, special, incidental, punitive or consequential damages, damages relating to corruption, security, loss or theft of data, viruses, spyware, loss of business, revenue, profits, or investment, or use of software or hardware that does not meet Banner minimum systems requirements. The above limitations apply even if Banner and its affiliates and channel partners have been advised of the possibility of such damages. This Agreement sets forth the entire liability of Banner, its affiliates and your exclusive remedy with respect to the software use.

### Banner Engineering Corp Limited Warranty

Banner Engineering Corp. warrants its products to be free from defects in material and workmanship for one year following the date of shipment. Banner Engineering Corp. will repair or replace, free of charge, any product of its manufacture which, at

the time it is returned to the factory, is found to have been defective during the warranty period. This warranty does not cover damage or liability for misuse, abuse, or the improper application or installation of the Banner product.

**THIS LIMITED WARRANTY IS EXCLUSIVE AND IN LIEU OF ALL OTHER WARRANTIES WHETHER EXPRESS OR IMPLIED (INCLUDING, WITHOUT LIMITATION, ANY WARRANTY OF MERCHANTABILITY OR FITNESS FOR A PARTICULAR PURPOSE), AND WHETHER ARISING UNDER COURSE OF PERFORMANCE, COURSE OF DEALING OR TRADE USAGE.**

This Warranty is exclusive and limited to repair or, at the discretion of Banner Engineering Corp., replacement. **IN NO EVENT SHALL BANNER ENGINEERING CORP. BE LIABLE TO BUYER OR ANY OTHER PERSON OR ENTITY FOR ANY EXTRA COSTS, EXPENSES, LOSSES, LOSS OF PROFITS, OR ANY INCIDENTAL, CONSEQUENTIAL OR SPECIAL DAMAGES RESULTING FROM ANY PRODUCT DEFECT OR FROM THE USE OR INABILITY TO USE THE PRODUCT, WHETHER ARISING IN CONTRACT OR WARRANTY, STATUTE, TORT, STRICT LIABILITY, NEGLIGENCE, OR OTHERWISE.**

Banner Engineering Corp. reserves the right to change, modify or improve the design of the product without assuming any obligations or liabilities relating to any product previously manufactured by Banner Engineering Corp. Any misuse, abuse, or improper application or installation of this product or use of the product for personal protection applications when the product is identified as not intended for such purposes will void the product warranty. Any modifications to this product without prior express approval by Banner Engineering Corp will void the product warranties. All specifications published in this document are subject to change; Banner reserves the right to modify product specifications or update documentation at any time. Specifications and product information in English supersede that which is provided in any other language. For the most recent version of any documentation, refer to: [www.bannerengineering.com](http://www.bannerengineering.com).

For patent information, see [www.bannerengineering.com/patents](http://www.bannerengineering.com/patents).

## Document Information

Document title: T30R R-GAGE® Series Sensor Instruction Manual

Part number: 217048

Revision: F

Original Instructions

© Banner Engineering Corp. All rights reserved.



217048

 [LinkedIn](#)

 [Twitter](#)

 [Facebook](#)

