

GETTING STARTED

# X-Microwave System [X-MWsystem]

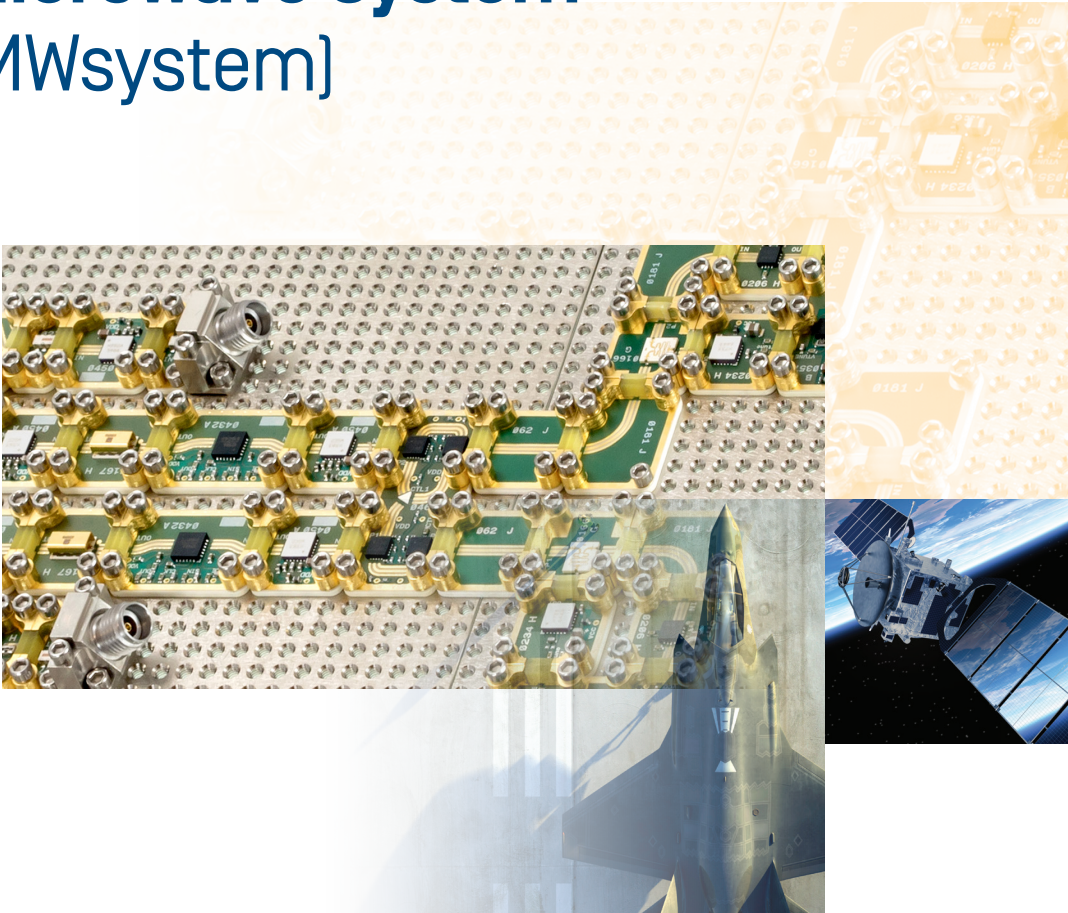

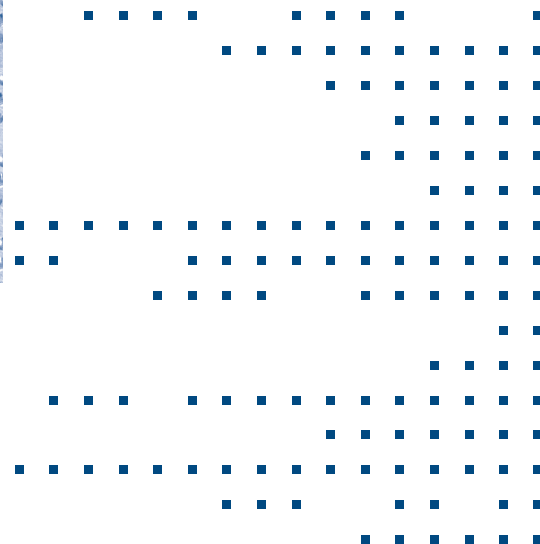
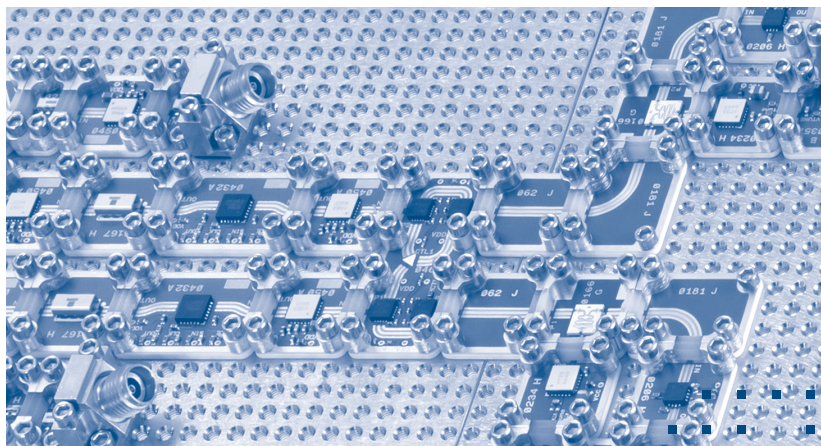

## Overview

RF and Microwave design and product development is an incredibly interesting and challenging field. The “Craft is truly an art” and it takes years to learn and hone the required skills. First pass design success is challenging even for experienced designers. Higher frequencies, lower power consumption, smaller size requirements and lower cost are constant pressures. Despite the challenges, we “analog geeks” love our jobs because we love to solve challenging problems.

### **The X-MWsystem is built upon two key resources:**

1. A complete modular building block ecosystem of RF and microwave components, and test and production accessories for rapid prototyping [introduced in this document].
2. X-Parameter Technology, including free models and an Online system simulator—powered by Keysight’s Genesys and Spectrasys. [More information at [quanticxmw.com](http://quanticxmw.com)]

# X-MWsystem Vocabulary

## Modular Drop-In Building Blocks [X-MWblocks]

There are two primary types of modular X-MWblocks: RF X-MWblocks, and Bias and Control X-MWblocks. RF X-MWblocks typically perform one or more operations on an analog signal such as amplification, dividing, combining, attenuation, and more. Passive blocks operate without additional circuitry. Active blocks require supply voltage and/or control.

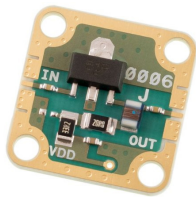

RF X-MWblock

### RF X-MWblocks

All blocks are designed to be compatible to a common size and connectivity standard. Blocks operating up to 50 GHz are built in a 4-layer board architecture where most signals are routed along the top layer separated by 8 mil Rogers 4003 to layer 2 ground. Layer 3 is used when needing to route signals with Layer 4 on the bottom, making ground contact with the prototyping plate. New backward-compatible technologies and layer topologies are in development to support higher frequency components.



Bias and Control X-MWblock

### Bias and Control X-MWblocks

The grid can be thought of as a standard H-frame design with microwave components on top and with low-frequency bias voltage and control circuitry on bottom. Bias and/or control is provided from the bottom side of the prototyping plate through shielded spring-pin connections. Bias and control X-MWblocks most often consist of voltage regulators and digital components. The bias and control boards are typically made from a common FR-4 material.

## X-MWprotoplate

The prototyping plate serves as the foundation of the design system. Screw holes are placed in a 0.135 x 0.135 inch grid pattern of 1-72 threaded holes. The space between each hole is measured as 1 grid unit. X-MWblock sizes are integer multiples of the grid spacing. The last four digit grouping in the part number indicate block size in X-MWgrid units. For example, the most common block size is 0404 which means 4 grid units by 4 grid units (0.54" x 0.54").

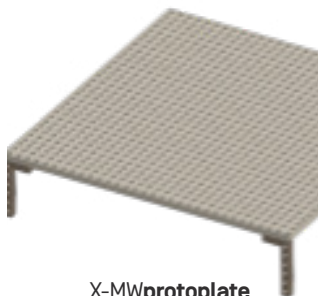

X-MWprotoplate

The X-MWgrid is offered in multiple metal options. Stainless steel provides the most durable prototyping plate. Other materials such as nickel-plated brass and nickel-plated copper offer better heat dissipation, but the softer metal is easier to damage by over-tightening screws.

### **X-MWprobe**

The solderless X-MWprobe is a precision machined RF connector designed for repeated use throughout the design process. Offered in multiple sizes, the X-MWprobe provides high quality measurements up to 65 GHz. The 2.92 mm [SMA Compatible] probe connection makes a solid connection with each side of the ground plane while the center pin makes contact with the signal trace on the launch. The probe can be installed and removed hundreds of times with minimal degradation.



X-MWprobe

## **Building Circuits**

One or more X-MWblocks are placed on the top of the prototyping plate and are fastened with 1-72 threaded screws.

### **Single X-MWblock**

A single component can be interfaced by the outside world by placing probes on each end of the X-MWblock. Each probe requires 4 screws, which secure the probe to both the X-MWprotoplate and the X-MWblock. A single block can be analyzed by connecting a X-MWprobe to each launch.

### **Multiple X-MWblocks**

Multiple X-MWblocks are combined to build a signal chain. They are placed on the grid with their launches aligned and a 5 mil gap in between. The X-MWjumper flex-circuit and anchors provide a low-loss interconnect. Alternatively, solder ribbon, silver epoxy, and wire bonding can also be used to connect X-MWblocks. The solderless interconnect is ideal for prototyping because it provides a relatively quick method for building and changing out parts with excellent RF performance.

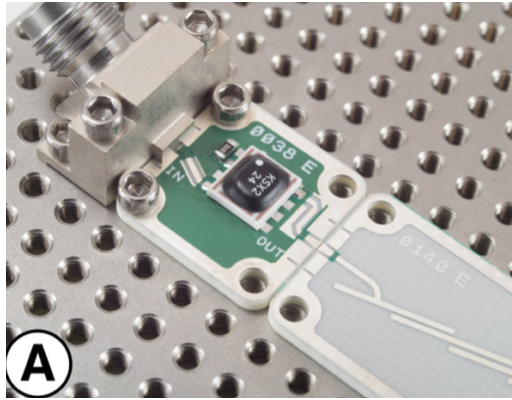

**A** X-MWblocks on a prototyping plate.



**B** X-MWanchor shown with two GSG jumpers.

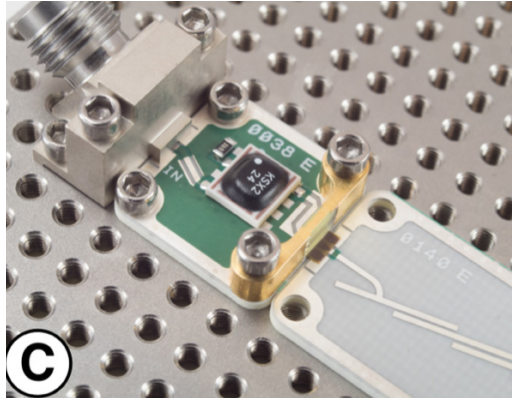

**C** An X-MWanchor secures a jumper across the 5 mil air gap.

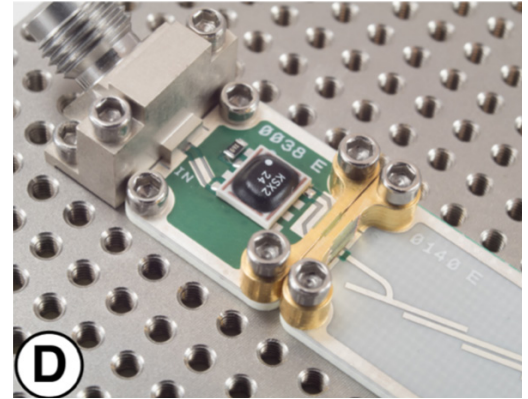

**D** Each side of the GSG jumper is secured by an anchor.

## Solderless Interconnect

Circuits are built by combining multiple X-MWblocks on the prototyping plate **[A]**, by placing the GSG jumper **[B]**, shiny side down, across the 5 mil air gap **[C]**, and securely anchoring each side of the jumper **[D]**. Anchor screws should only be lightly tightened to “finger-tight” which is 10 oz-in (7 N-cm). The X-MWjumper flex-circuit interconnect performs well from DC to beyond 60 GHz.



X-MWjumper  
[Ground-Signal-Ground  
[GSG] Jumper]



X-MWanchor  
[above an  
X-MWjumper]

## Flex Circuit Board-to-Board Interconnect

The X-MWjumper is coated in diamond dust and then gold plated to provide a robust ground-signal-ground solderless interconnect between boards. It is often placed with tweezers, centered between two X-MWblocks. The two anchors press the rough surface of the X-MWjumper into the surface of the PCB trace, increasing surface area. The flexible nature of the interconnect is critical, allowing for both thermal expansion and compensation for small inconsistencies in the thickness of the adjacent block.

**Tip:** The flex circuit interconnect should be mounted gold side down, ensuring all three traces connect the ground-signal-ground connections between two boards.

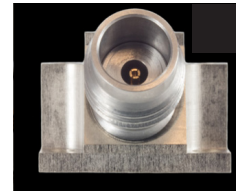
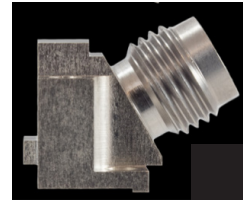
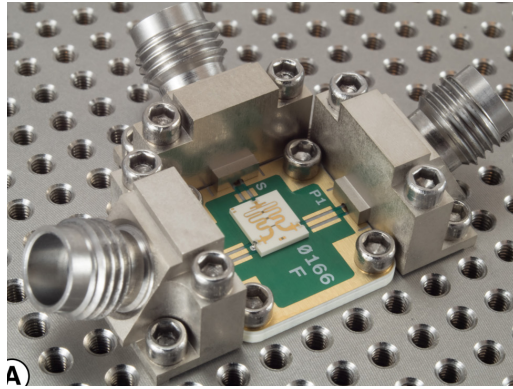

## Using the X-MWprobe

The X-MWprobe is placed down on the prototyping plate with the probe edge over the desired launch of the X-MWblock. Carefully center the probe between the light lines on the edge of the PCB. First, install the bottom screws and lightly tighten them to keep the probe perpendicular. Secondly, install the top screws. In a final pass, tighten all screws to the torque specification of 7 oz-in [5 N-cm]. Do not over-tighten the screws; you could crush the board or damage the threaded holes in the prototyping plate.

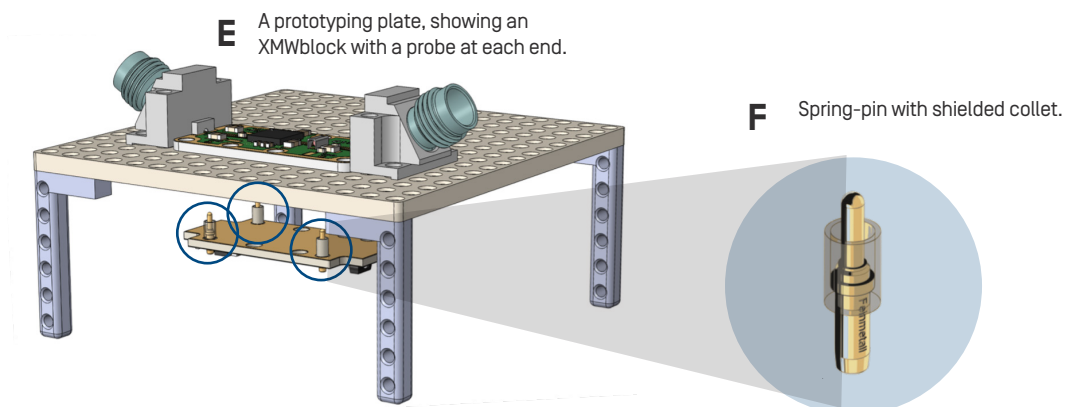

## Bias and Control

Matched bias voltage and control circuitry are placed on the bottom of the prototyping plate [E], supplying the microwave blocks with the necessary power and control signals. Spring-pins with shielded collets [F] are soldered to the bias and control circuit board, providing a shielded electrical connection through the prototyping plate to the RF X-MWblock.

In some cases, a single voltage is supplied. In other cases, a single supply voltage is regulated and supplied as multiple bias voltages that are sequenced at power-up. If a more robust connection is needed, the spring pins can be removed and replaced with soldered solid core shielded wire using the existing holes.

**Tip:** The microwave top board and the bottom bias and control board do not need to be the same size. However, the pins on the bottom board need to line up with the correct pads on the top board.

G

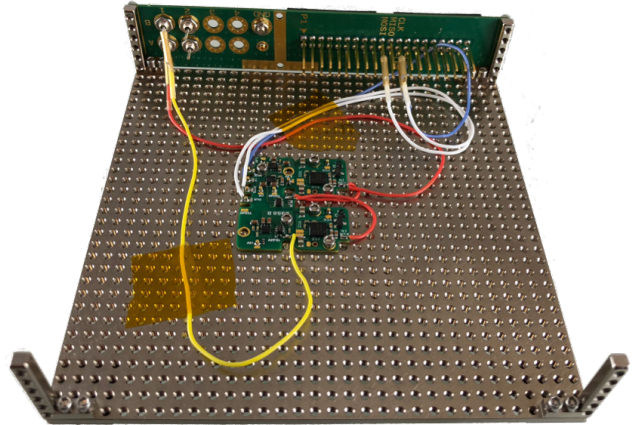
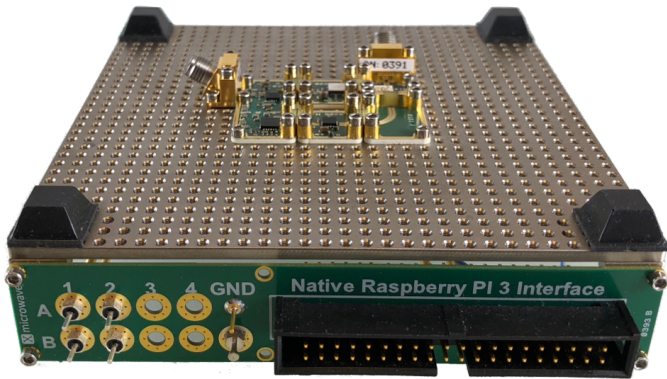

### Powering the Bias and Control Board

You will need to solder flexible shielded wire between the bias and control board and the interface board mounted to the side of the prototyping plate. Feedthrough capacitors are typically used on DC power sources as a noise block. In some cases, when the control board is still in development, breakout boards (G) can be used to provide bias and control. A stable benchtop supply is typically used with clip-on leads to provide the appropriate power to each feedthrough capacitor. It is important to note the prototyping plate serves as a common ground. Letters and numbers are printed on the interface PCB to aid in your own system documentation.

Tip: Product pages on [xmicrowave.com](http://xmicrowave.com) show diagrams of boards with silk screen markings and I/O points.

### Control for the Bias and Control Board

A standard 40-pin IDC cable interface (compatible with a standard Raspberry PI control board) is provided for digital IO and serial peripheral interface (SPI) communications. Quantic X-Microwave provides a touch screen interface integrated with Raspberry PI for programming all supported parts. The convenient interface stores your board configurations and register maps for quick, computer-free benchtop prototyping.

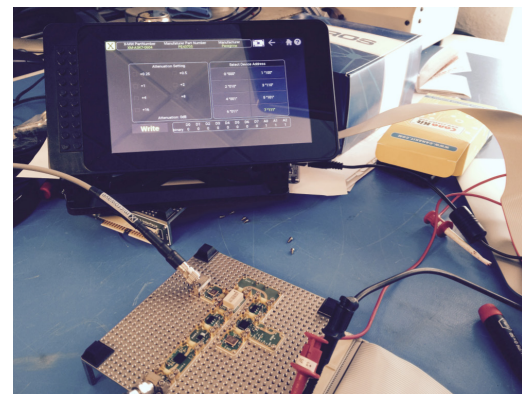

# Mechanical Elements

## Screws

All screws are 1-72 socket head cap screws made of 18/8 stainless steel. Using the proper length screw is important to ensure nothing protrudes through the top or bottom of the prototyping plate.

**Tip:** Be sure to use the correct length screws. Using screws that are too long can scratch or break the board below it. The screws in a single bag can also vary in length due to manufacturing variability.



X-MWblocks  
[bottom of plate]  
1-72 × 1/8"  
[0.125"]



X-MWblocks [top]  
X-MWprobe [short]  
1-72 × 5/32"  
[0.156"]



Lid [top]  
1-72 × 3/16"  
[0.187"]



X-MWanchor  
Pinbridge  
1-72 × 1/4"  
[0.25"]



X-MWprobe [tall]  
X-MWwall [short]  
1-72 × 3/8"  
[0.375"]



X-MWwall [tall]  
1-72 × 1/2"  
[0.5"]



X-MWwall  
Edge with Lid  
1-72 × 5/8"  
[0.625"]



X-MWwall

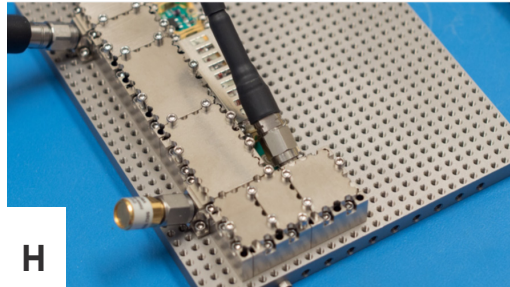

H

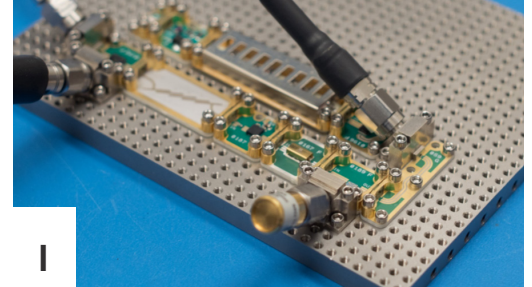

I



X-MWlid

## X-MWwalls and X-MWlids

Modular wall and lid pieces [H] allow you to prototype arbitrarily-shaped mechanical housings around your designs [I] to better understand how custom enclosures might impact the behavior of your design. The walls are designed to screw into the prototyping plate with a Spira-Shield at the edge to eliminate any gaps and ensure electrical continuity. Additionally, internal shielding is available if needed.

Learn more at [quanticxmw.com](https://quanticxmw.com)

Quantic™ X-Microwave