

ADJUSTABLE PRECISION SHUNT REGULATOR

■ GENERAL DESCRIPTION

The NJM431S/NJM432S are adjustable precision shunt regulators. The output voltage may be set to any value between V_{REF} (about 2.5V) and 36V by two resistors. Compared to the conventional 431, the NJM431S/NJM432S are improved the voltage accuracy. And they have smaller package option to support a wide range of applications. The NJM432S is the pin assignment option.

■ PACKAGE OUTLINE

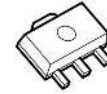

NJM431SU
NJM432SU
(SOT-89-3)

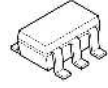

NJM431SF
NJM432SF
(SOT-23-5)

■ FEATURES

- Operating Voltage V_{REF} to 36V
- Precision Voltage Reference $2.495 \pm 1.8\%$
- Adjustable Output Voltage
- Bipolar Technology
- Package Outline

NJM431SU / NJM432SU	SOT-89-3
NJM431SF / NJM432SF	SOT-23-5

■ BLOCK DIAGRAM / SYMBOL

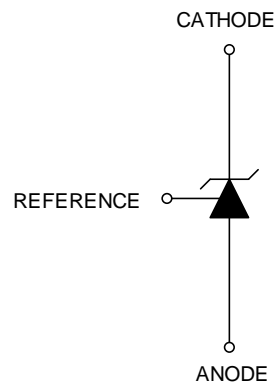
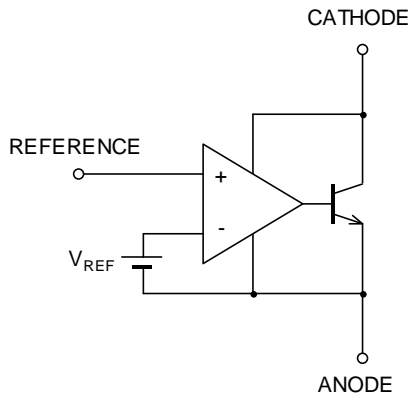

■ PIN CONFIGURATION

NJM431SU

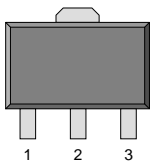

1. REFERENCE
2. ANODE
3. CATHODE

NJM431SF

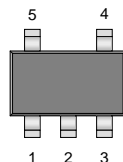

1. N.C.
2. ANODE*
3. CATHODE
4. REFERENCE
5. ANODE

* Pin 2 is attached to Substrate
and must be connected to
ANODE or left open.

NJM432SU

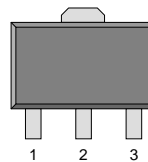

1. CATHODE
2. ANODE
3. REFERENCE

NJM432SF

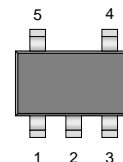

1. N.C.
2. ANODE
3. N.C.
4. CATHODE
5. REFERENCE

NJM431S/NJM432S

■ ABSOLUTE MAXIMUM RATINGS

($T_a=25^\circ\text{C}$)

PARAMETER	SYMBOL	MAXIMUM RATINGS	UNIT
Cathode Voltage	V_{KA}	37 (*1)	V
Continuous Cathode Current	I_K	-100 to 150	mA
Reference Input Current	I_{REF}	-0.05 to 10	mA
Power Dissipation	P_D	SOT-89-3 : 450(*2) : 1300(*3)	mW
		SOT-23-5 : 480(*4) : 650(*5)	
Operating Temperature Range	T_{opr}	-40 to +125	$^\circ\text{C}$
Storage Temperature Range	T_{stg}	-50 to +150	$^\circ\text{C}$

(*1) Unless specified, all voltage value are with respect to the anode pin.

(*2) Mounted on glass epoxy board. (76.2 × 114.3 × 1.6mm: EIA/JEDEC standard size, 2Layers)

(*3) Mounted on glass epoxy board. (76.2 × 114.3 × 1.6mm: EIA/JEDEC standard size, 4Layers)

(For 4Layers: Applying 74.2×74.2mm inner Cu area and a thermal via hole to a board based on JEDEC standard JESD51-5)

(*4) Mounted on glass epoxy board. (76.2 × 114.3 × 1.6mm: EIA/JEDEC standard size, 2Layers)

(*5) Mounted on glass epoxy board. (76.2 × 114.3 × 1.6mm: EIA/JEDEC standard size, 4Layers),

internal Cu area: 74.2 × 74.2mm

■ RECOMMENDED OPERATING CONDITIONS

PARAMETER	SYMBOL	MIN.	TYP.	MAX.	UNIT
Cathode Voltage	V_{KA}	V_{REF}	-	36	V
Cathode Current	I_K	0.7	-	100	mA

■ ELECTRICAL CHARACTERISTICS

($I_K=10\text{mA}$, $T_a=25^\circ\text{C}$)

PARAMETER	SYMBOL	TEST CONDITIONS	MIN.	TYP.	MAX.	UNIT
Reference Voltage	V_{REF}	$V_{KA}=V_{REF}$ (*6)	2450	2495	2540	mV
Reference Input Voltage Change Over Temperature Range	ΔV_{REF} (dev)	$V_{KA}=V_{REF}$ (*6) $T_a=-40^\circ\text{C}$ to $+85^\circ\text{C}$	-	8	17	mV
Reference Voltage Change vs. Cathode Voltage Change	$\frac{\Delta V_{REF}}{\Delta V_{KA}}$	(*7) $\Delta V_{KA}=10\text{V}-V_{REF}$ $\Delta V_{KA}=36\text{V}-10\text{V}$	-	-1.4 -1	-2.7 -2	mV/V
Reference Input Current	I_{REF}	$R1=10\text{k}\Omega$, $R2=\infty$ (*7)	-	2	4	μA
Reference Input Current Change Over Temperature Range	ΔI_{REF} (dev)	$R1=10\text{k}\Omega$, $R2=\infty$ (*7) $T_a=-40^\circ\text{C}$ to $+85^\circ\text{C}$	-	0.4	1.2	μA
Minimum Cathode Current	I_{MIN}	$V_{KA}=V_{REF}$ (*6)	-	0.4	0.7	mA
OFF State Cathode Current	I_{OFF}	$V_{KA}=36\text{V}$, $V_{REF}=0\text{V}$ (*8)	-	0.1	1.0	μA
Dynamic Impedance	$ Z_{KA} $	$V_{KA}=V_{REF}$, $I_K=1\text{mA}$ to 100mA , $f \leq 1\text{kHz}$ (*6)	-	0.2	0.5	Ω

The maximum value of “Dynamic Impedance“, “Reference Voltage Change” and “Reference Input Current Change” are determined based on sampling evaluation from the initial production lots, and thus not tested in the production test. Therefore, these values are for the reference design purpose only.

(*6) Test Circuit Fig.1

(*7) Test Circuit Fig.2

(*8) Test Circuit Fig.3

■ TEST CIRCUIT

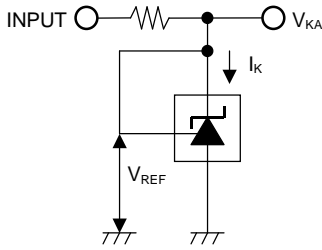

Fig.1 Test Circuit for $V_{KA}=V_{REF}$

$$V_O = V_{KA} = V_{REF}$$

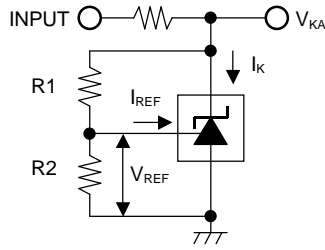

Fig. 2 Test Circuit for $V_{KA}>V_{REF}$

$$V_O = V_{KA} = V_{REF} \left(1 + \frac{R1}{R2} \right) + I_{REF} \times R1$$

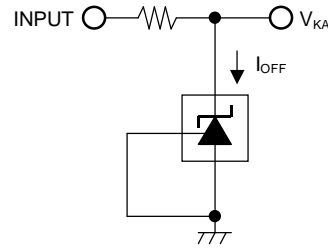
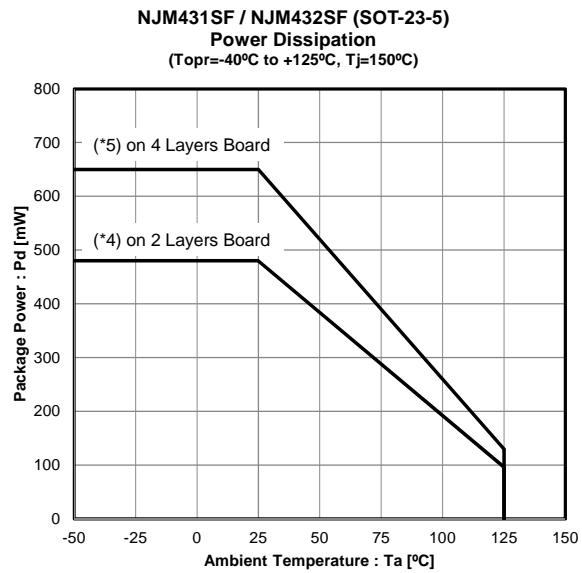
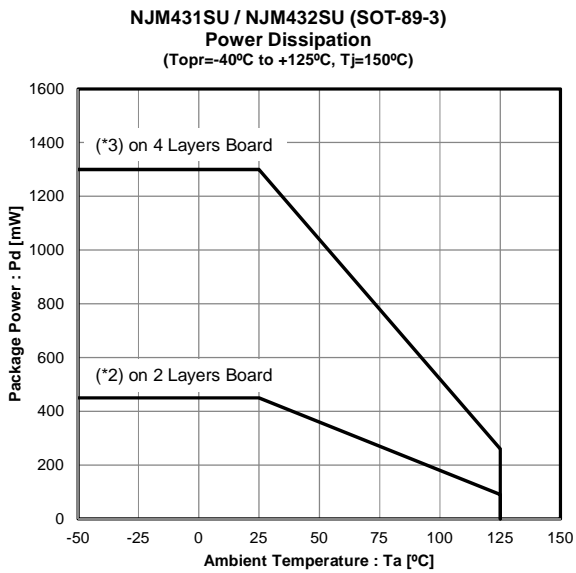

Fig.3 Test Circuit for I_{OFF}

■ POWER DISSIPATION vs. AMBIENT TEMPERATURE



(*2) Mounted on glass epoxy board. (76.2 × 114.3 × 1.6mm: EIA/JEDEC standard size, 2Layers)

(*3) Mounted on glass epoxy board. (76.2 × 114.3 × 1.6mm: EIA/JEDEC standard size, 4Layers)

(For 4Layers: Applying 74.2×74.2mm inner Cu area and a thermal via hole to a board based on JEDEC standard JESD51-5)

(*4) Mounted on glass epoxy board. (76.2 × 114.3 × 1.6mm: EIA/JEDEC standard size, 2Layers)

(*5) Mounted on glass epoxy board. (76.2 × 114.3 × 1.6mm: EIA/JEDEC standard size, 4Layers),

internal Cu area: 74.2 × 74.2mm

NJM431S/NJM432S

TYPICAL CHARACTERISTICS

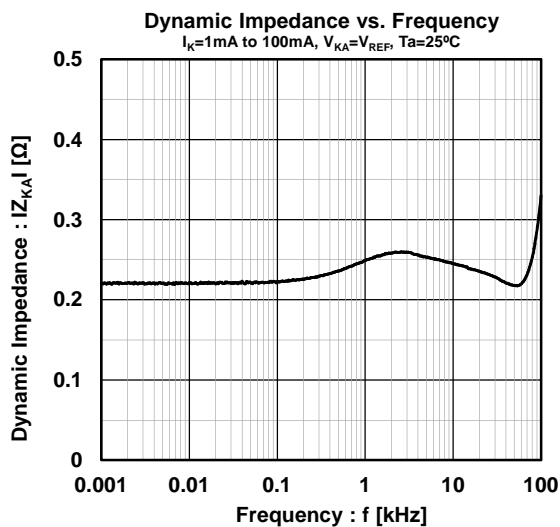
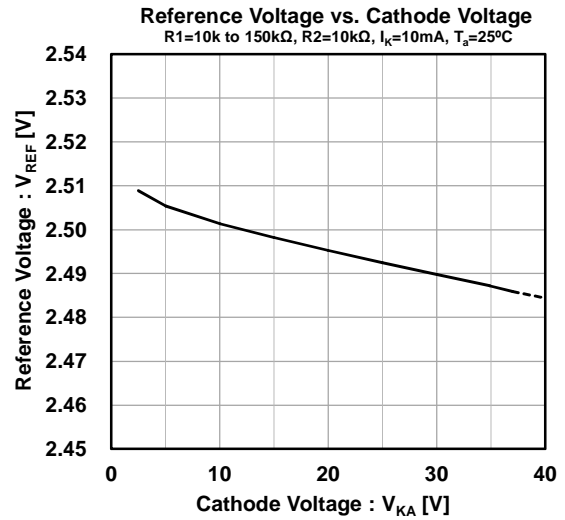
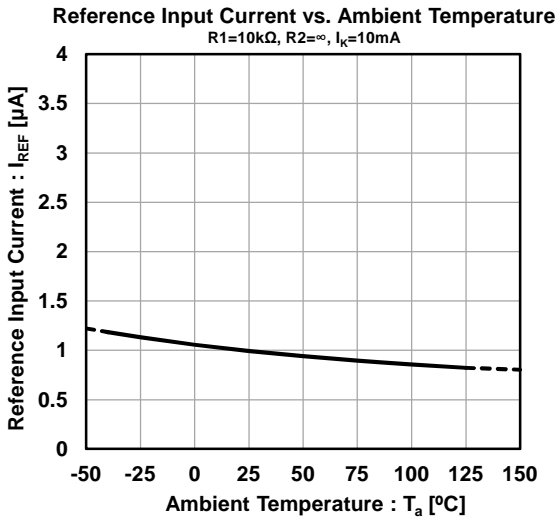
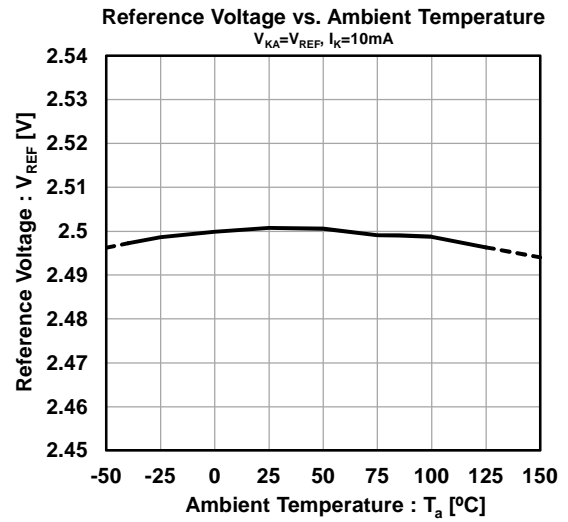
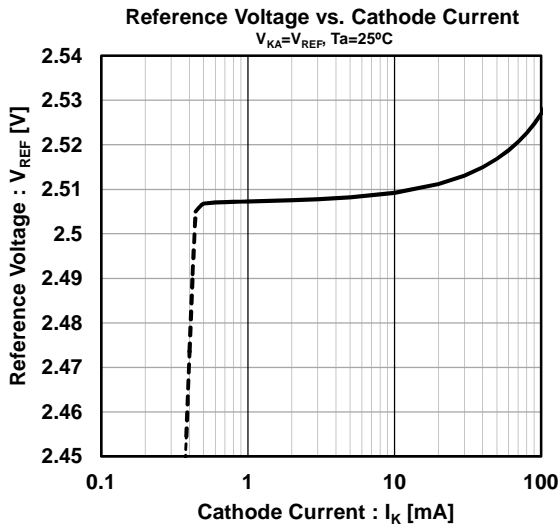

■ TYPICAL CHARACTERISTICS

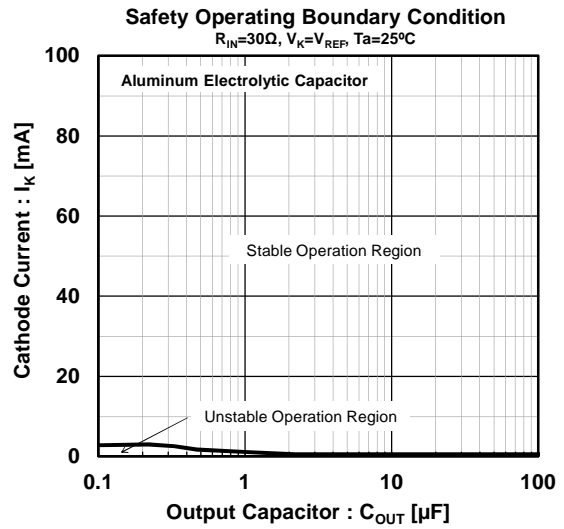
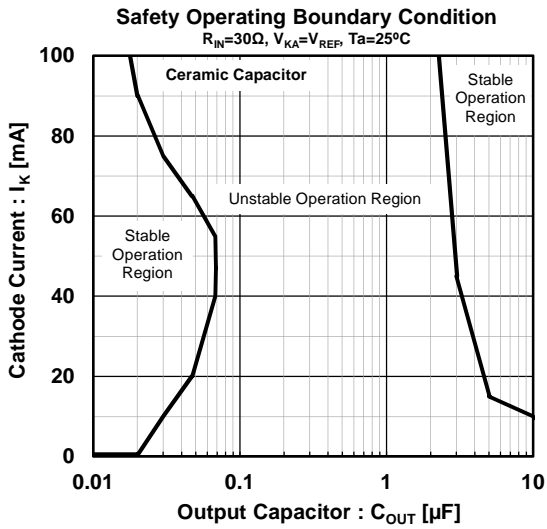

Safety Operating Boundary Condition Test Circuit

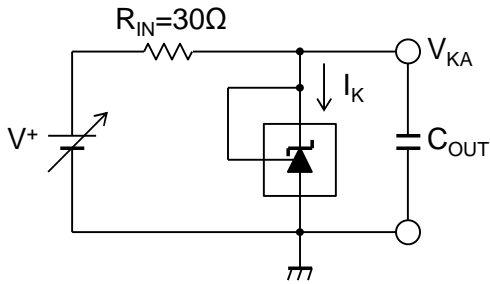

Note) Oscillation might occur while operating within the range of safety curve.

So that, it is necessary to make ample margins by taking considerations of fluctuation of the device.

[CAUTION]

The specifications on this databook are only given for information, without any guarantee as regards either mistakes or omissions. The application circuits in this databook are described only to show representative usages of the product and not intended for the guarantee or permission of any right including the industrial rights.