

## GRF5847

### 35 dBm Linear PA Module 4.4 to 5.2 GHz

#### FEATURES

- No External Matching
- Flexible Bias and Voltage Control
- Digital Shutdown
- Process: InGaP HBT

#### Reference: 5 V / 260 mA / 4.7 GHz

- Gain: 40 dB
- $P_{SAT}$ : 35.5 dBm
- Collector Efficiency: 52%
- Excellent EVM/ACLR vs.  $P_{OUT}$

#### APPLICATIONS

- C-Band Linear PA
- Point to Point Data Links
- Air Ground Air Operations
- Ship Shore Ship Operations
- N79 Wireless Infrastructure

#### DESCRIPTION

The GRF5847 is a PA module achieving 35+ dBm saturated output power from 4.4 to 5.2 GHz with power added efficiency greater than 50%. Due to its high native linearity, the device does not require digital predistortion. It can be operated over a range of supply voltage levels from 3 to 5 volts requiring no external matching.

Please consult with the GRF applications engineering team for custom tuning/evaluation board data.

#### BLOCK DIAGRAM

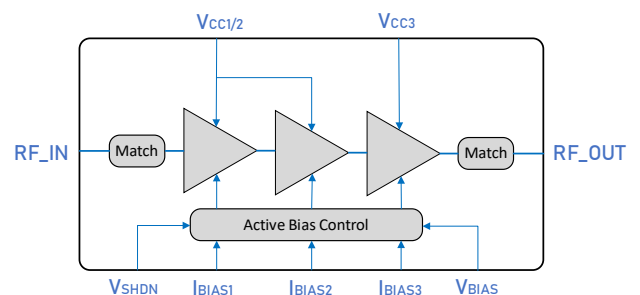

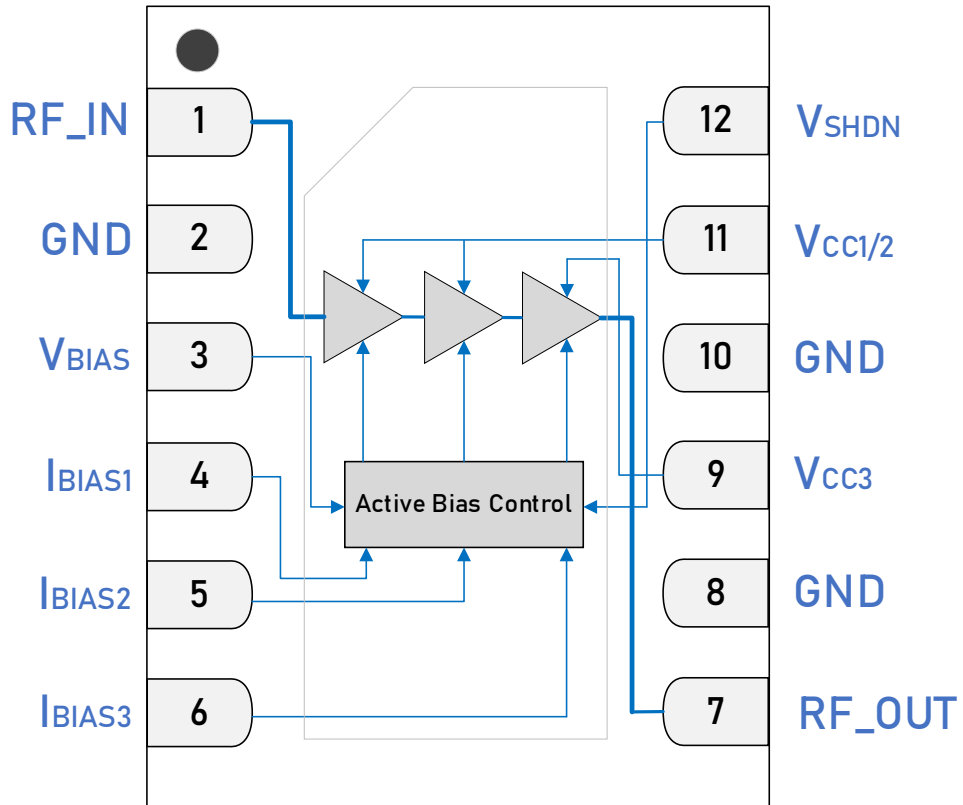

2.5 x 3.0 mm LAMM-12 Pin Out (Top View)

## Pin Assignments

Pin	Name	Description	Note
1	RF_IN	RF Input	Internally matched to 50 Ω. Connected to internal ESD protection circuit. Do not apply external DC voltage.
2, 8, 10	GND	Ground	Provides RF and DC ground for PA.
3	V <sub>BIAS</sub>	Bias Circuit Supply	Connect to V <sub>CC</sub> voltage.
4	I <sub>BIAS1</sub>	1 <sup>st</sup> Stage Bias Reference Current	Connect to V <sub>CC</sub> through an external resistor.
5	I <sub>BIAS2</sub>	2 <sup>nd</sup> Stage Bias Reference Current	Connect to V <sub>CC</sub> through an external resistor.
6	I <sub>BIAS3</sub>	3 <sup>rd</sup> Stage Bias Reference Current	Connect to V <sub>CC</sub> through an external resistor.
7	RF_OUT	RF Output	Internally matched to 50 Ω. Internally DC blocked.
9	V <sub>CC3</sub>	3 <sup>rd</sup> Stage Collector Voltage	Connect to V <sub>CC</sub> voltage.
11	V <sub>CC1/2</sub>	Collector Voltage for Stage 1 and 2	Connect to V <sub>CC</sub> voltage.
12	V <sub>SHDN</sub>	Digital Shutdown Pin	V <sub>SHDN</sub> ≥ 2 volts (Logic HIGH) disables device. V <sub>SHDN</sub> ≤ 0.8 volts (Logic LOW) enables device.
PKG BASE	GND	Ground	Provides DC and RF ground for the PA as well as thermal heat sink. Recommend multiple 8-mil vias beneath the package for optimal RF and thermal performance. Refer to evaluation board top layer graphic on schematic page.

## Absolute Ratings

Parameter	Symbol	Min.	Max.	Unit
Supply Voltage	V <sub>CC</sub>	0	5.5	V
Transient Average RF Input Power: Load VSWR < 2:1, V <sub>CC</sub> = 5 V. Duration: < 1 hour.	P <sub>IN MAX</sub>		TBD	dBm
Operating Temperature (Package Base)	T <sub>PKG BASE</sub>	-40	85	°C
Maximum Channel Temperature (MTTF: TBD)	T <sub>MAX</sub>		170	°C
Maximum Dissipated Power	P <sub>DISS MAX</sub>		TBD	W

## Electrostatic Discharge

Charged Device Model	CDM	TBD		V
Human Body Model	HBM	TBD		V

## Storage

Storage Temperature	T <sub>STG</sub>	-65	150	°C
Moisture Sensitivity Level	MSL		5A	--



**Caution! ESD Sensitive Device.**

**Exceeding Absolute Maximum Rating conditions may cause permanent damage.**

Note: For additional information, please refer to *Manufacturing Note MN-001 — Package and Manufacturing Information*.



All Guerrilla RF products are provided in RoHS compliant lead (Pb)-free packaging requiring no exemptions. Additional information for this topic can be found at this link - [Environmental and Restricted Substance Statement Library](#)

## Recommended Operating Conditions

Parameter	Symbol	Specification			Unit	Condition
		Min.	Typ.	Max.		
Supply Voltage	$V_{CC}$	2.7	5	5.5	V	
Operating Temperature (Package Base)	$T_{PKG\ BASE}$	-40		85	°C	
RF Frequency Range	$F_{RF}$	4.4		5.2	GHz	Typical application schematic.
RF_IN Port Impedance	$Z_{RF\_IN}$		50		$\Omega$	Single-ended.
RF_OUT Port Impedance	$Z_{RF\_OUT}$		50		$\Omega$	Single-ended.

## Nominal Operating Parameters – General

The following conditions apply unless noted otherwise: typical application schematic using the 4.4 to 5.2 GHz tuning set,  $V_{CC} = 5\text{ V}$ ,  $I_{CC} = 260\text{ mA}$ ,  $F_{TEST} = 4.7\text{ GHz}$ ,  $50\ \Omega$  impedance,  $T_{PKG\ BASE} = 25\ ^\circ\text{C}$ . Evaluation board losses are included within the specifications.

Parameter	Symbol	Specification			Unit	Condition
		Min.	Typ.	Max.		
Quiescent Current	$I_{CCQ}$		260		mA	
Bias Current ( $V_{CC1/2}$ )	$I_{BIAS\ V_{CC1/2}}$		55		mA	
Bias Current ( $V_{CC3}$ )	$I_{BIAS\ V_{CC3}}$		215		mA	
Enable Current	$I_{ENABLE}$		11		mA	
Switching Rise Time	$T_{RISE}$		TBD		ns	Disabled mode to Gain mode ( <b>note 3</b> ).
Switching Fall Time	$T_{FALL}$		TBD		ns	Gain mode to Disabled mode ( <b>note 4</b> ).

### Disabled Mode

Enable Current	$I_{ENABLE}$		750		$\mu\text{A}$	$V_{CC} = 5\text{ V}$ , $V_{SHDN} = 5\text{ V}$ , $V_{BIAS} = 5\text{ V}$ .
Bias Current	$I_{BIAS}$		17		mA	$V_{CC} = 5\text{ V}$ , $V_{SHDN} = 5\text{ V}$ , $V_{BIAS} = 5\text{ V}$ .

### Thermal Data

Thermal Resistance (Infrared Scan)	$\Theta_{JC}$		TBD		$^\circ\text{C}/\text{W}$	On standard evaluation board ( <b>note 5</b> ).
------------------------------------	---------------	--	-----	--	---------------------------	---

**Note 3:** Switching Time: 50% of  $V_{SHDN}$  to 90% of  $P_{OUT}$ .

**Note 4:** Switching Time: 50% of  $V_{SHDN}$  to 10% of  $P_{OUT}$ .

**Note 5:** MTTF: TBD.

## Nominal Operating Parameters – RF

The following conditions apply unless noted otherwise: typical application schematic using the 4.4 to 5.2 GHz tuning set,  $V_{CC} = 5\text{ V}$ ,  $I_{CC} = 260\text{ mA}$ ,  $F_{TEST} = 4.7\text{ GHz}$ ,  $50\ \Omega$  impedance,  $T_{PKG\ BASE} = 25\ ^\circ\text{C}$ . Evaluation board losses are included within the specifications.

Parameter	Symbol	Specification			Unit	Condition
		Min.	Typ.	Max.		
Gain	S <sub>21</sub>		40		dB	
Saturated Output Power	P <sub>SAT</sub>		35.5		dBm	
Peak Collector Efficiency	$\eta$		52		%	
Noise Figure	NF		4.8		dB	On standard evaluation board.
Output 3 <sup>rd</sup> Order Intercept Point	OIP3		43		dBm	P <sub>OUT</sub> = 26 dBm per tone at 600 kHz spacing.

GRF5847 Typical Operating Curves: 4.4 to 5.2 GHz Tune

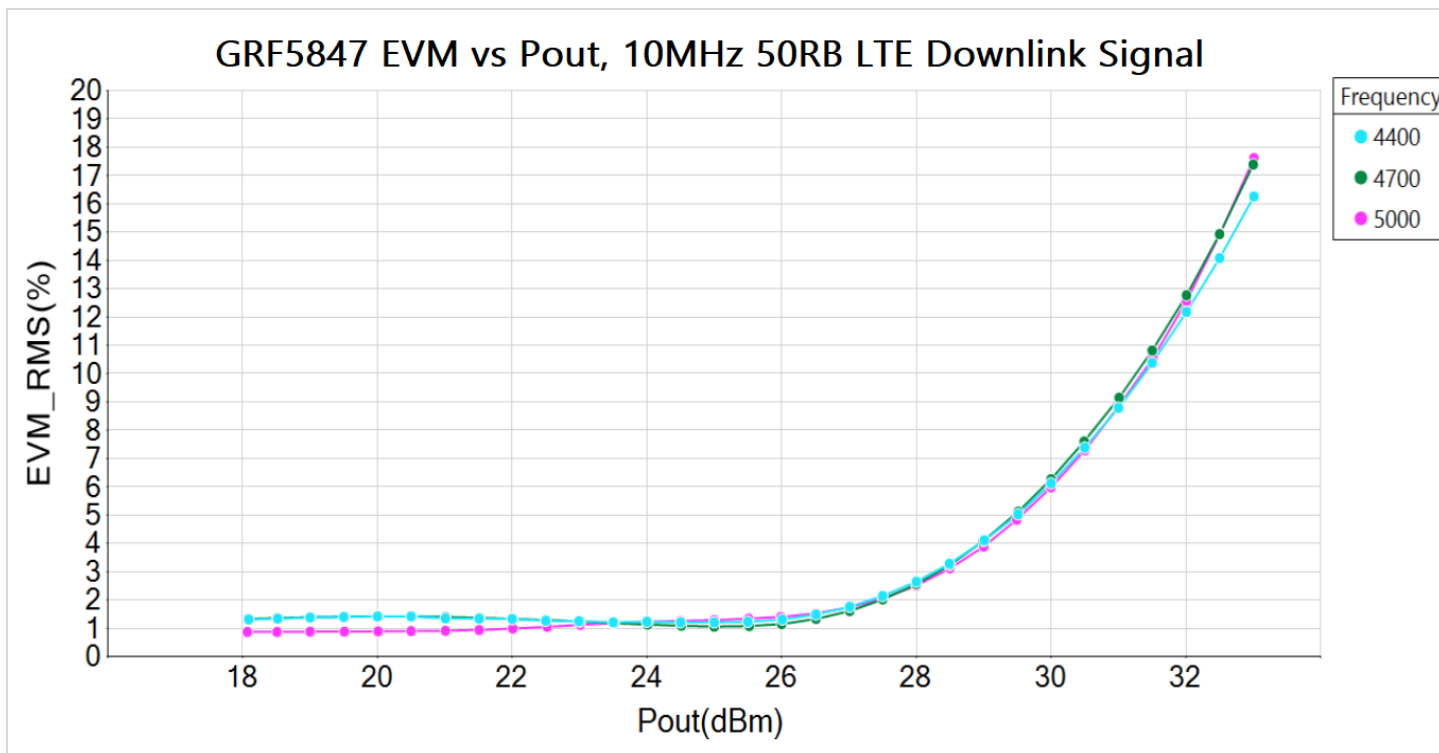
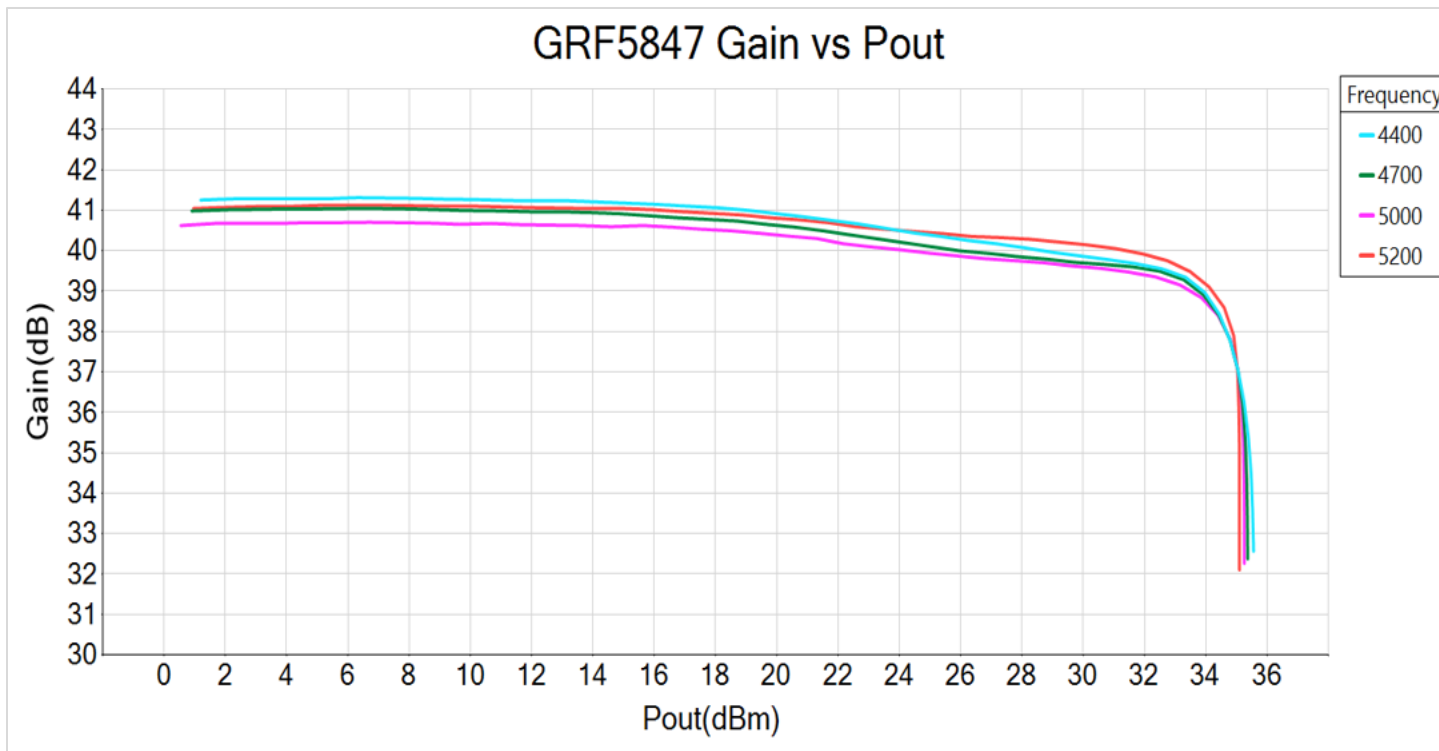

GRF5847 Typical Operating Curves: 4.4 to 5.2 GHz Tune

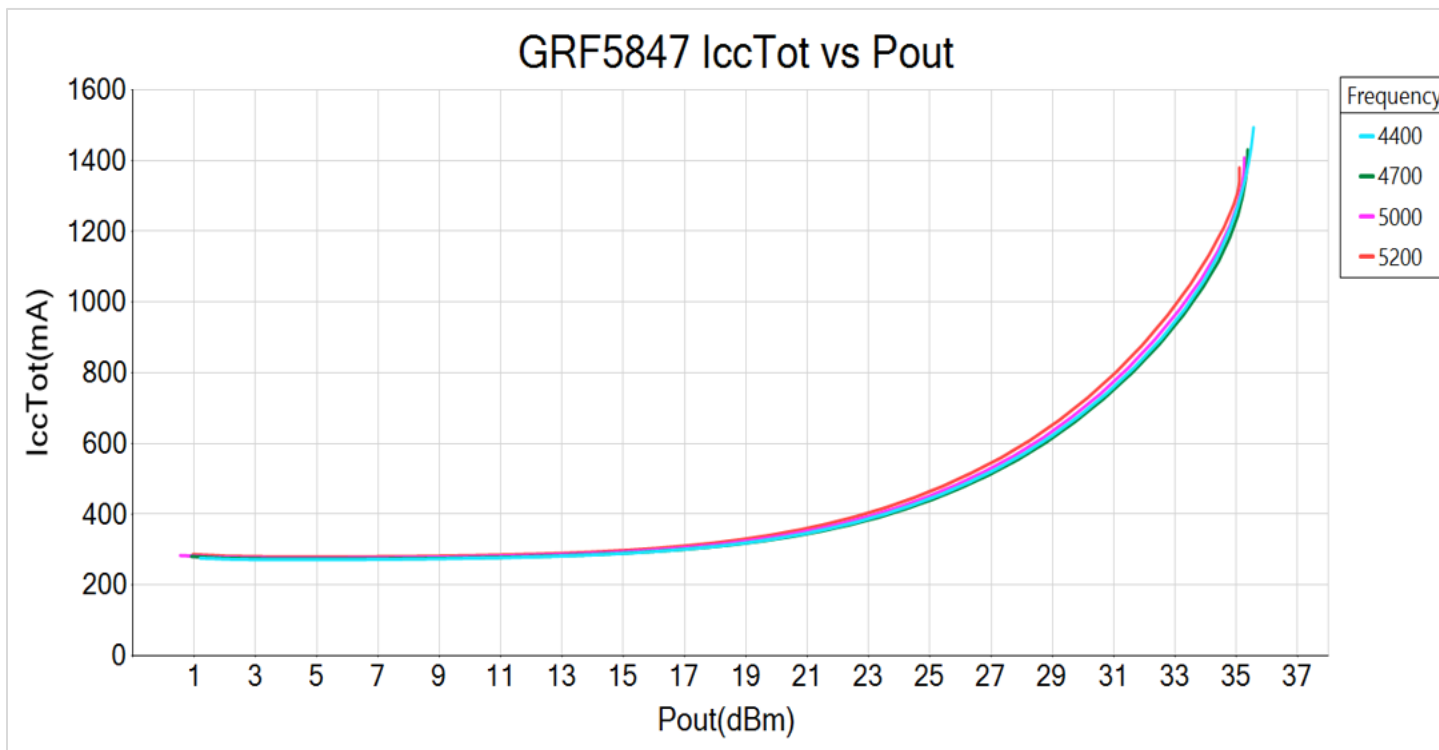
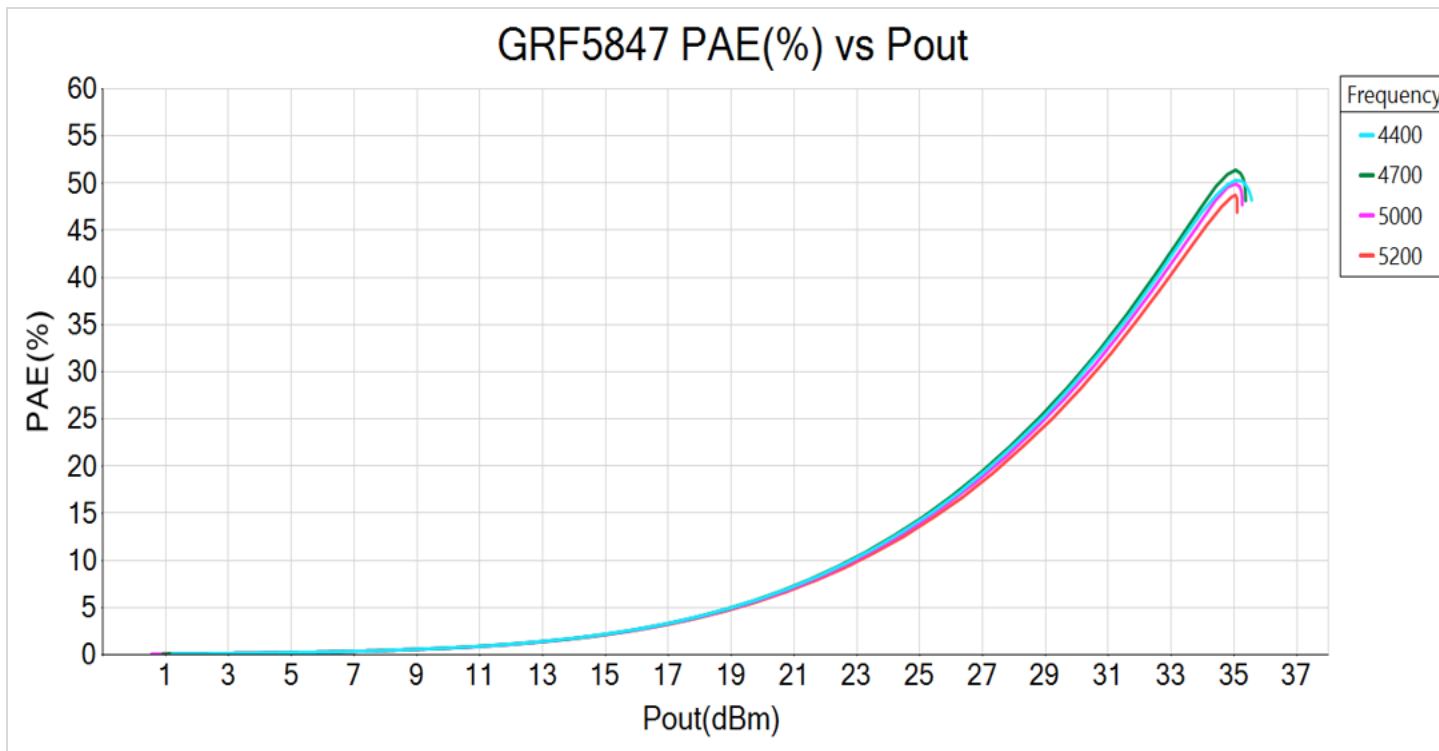

GRF5847 Typical Operating Curves: 4.4 to 5.2 GHz Tune

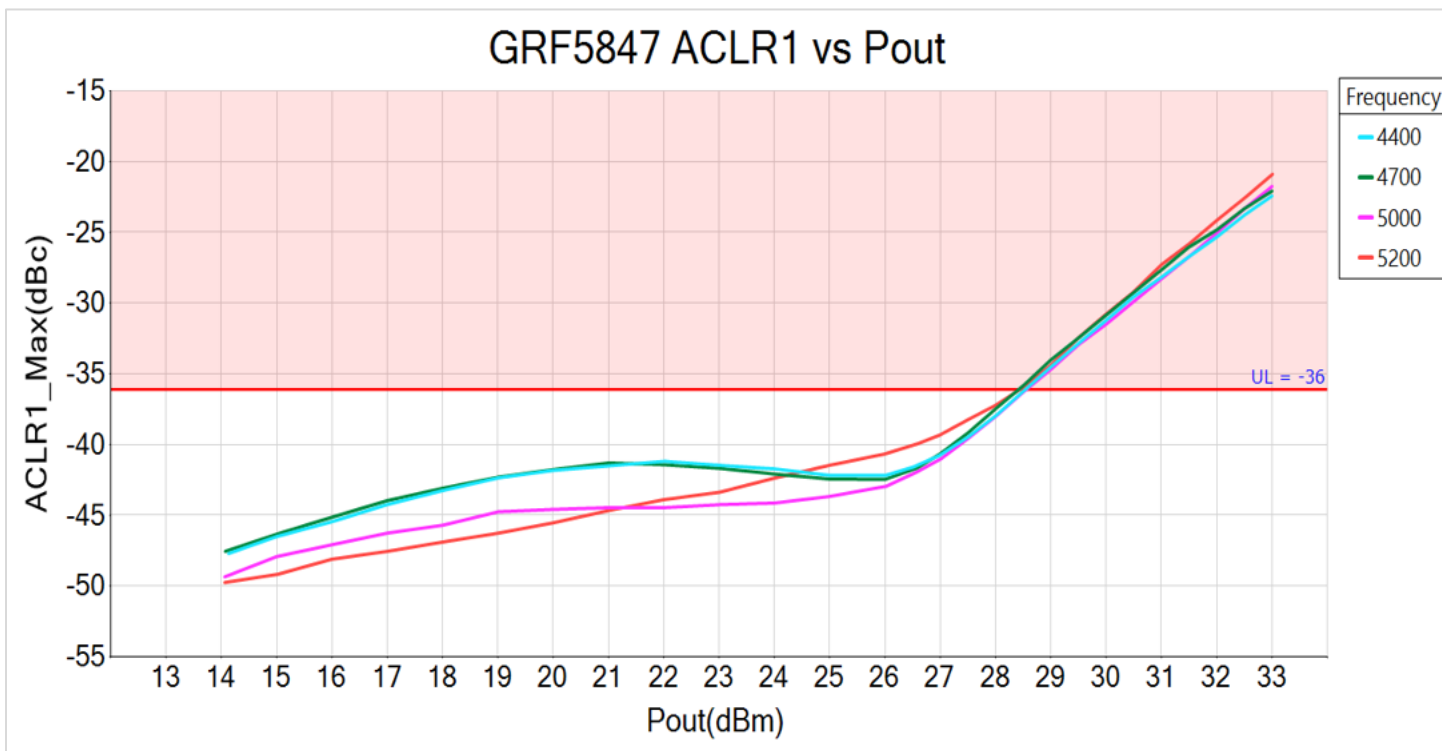
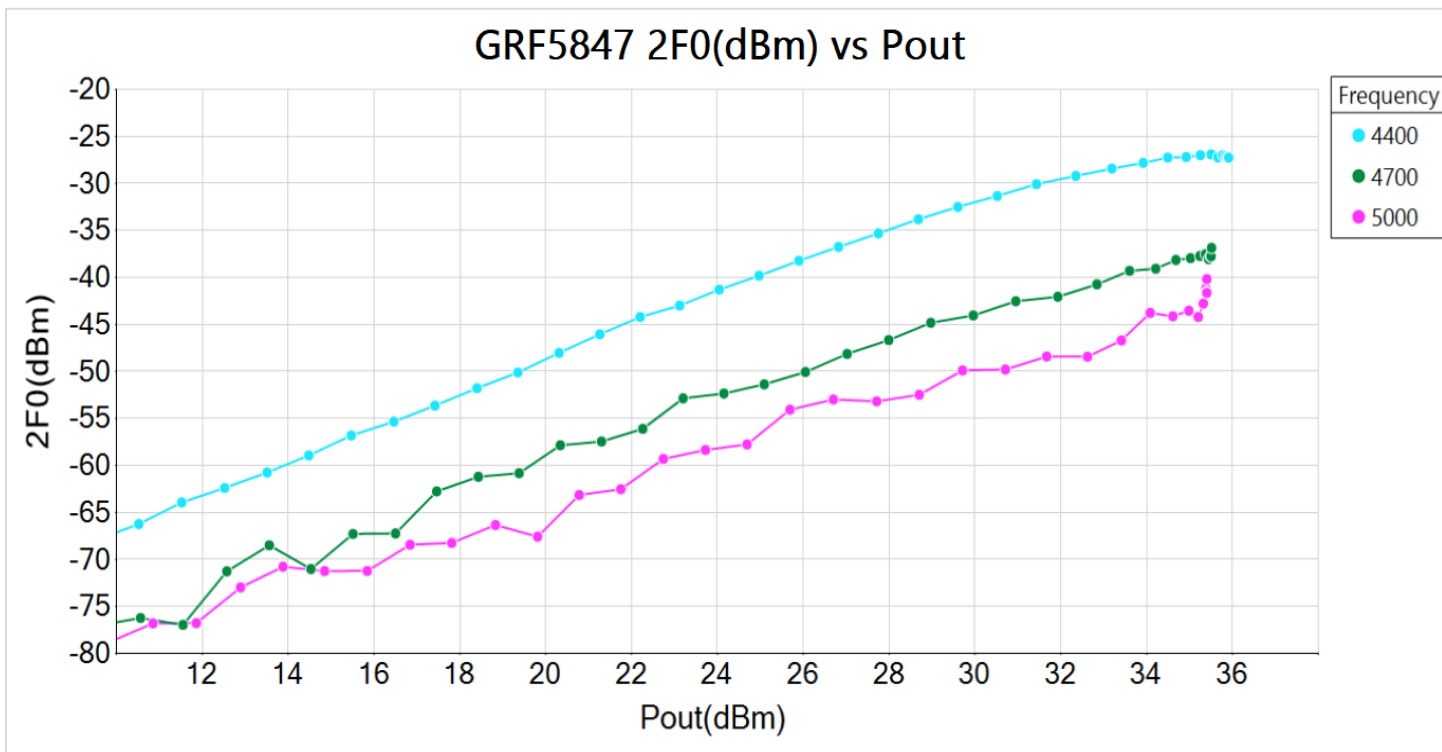

GRF5847 Typical Operating Curves: S-Parameters (4.4 to 5.2 GHz Tune)

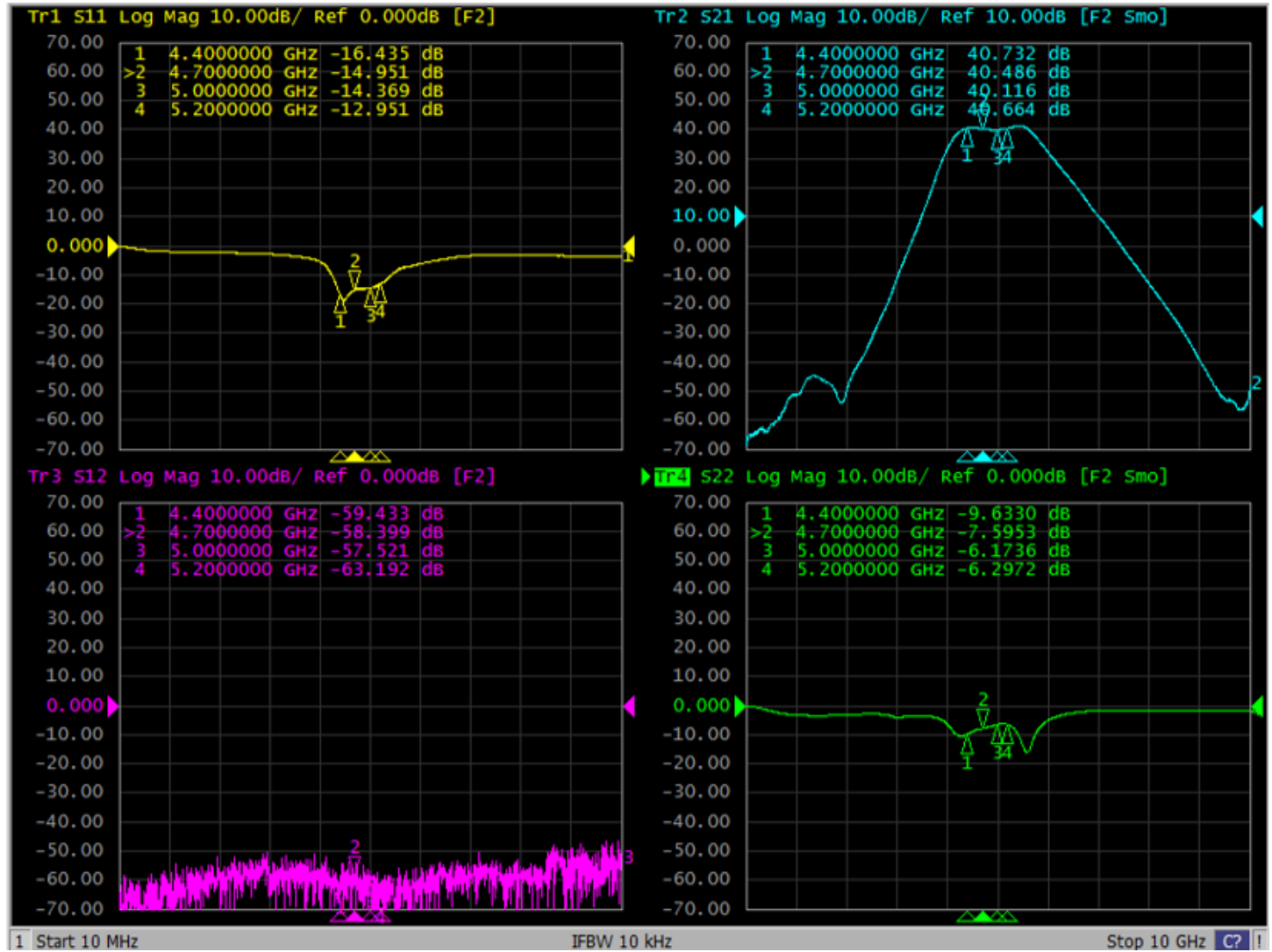

GRF5847 Typical Operating Curves: Stability Mu Factor (10 MHz to 20 GHz)

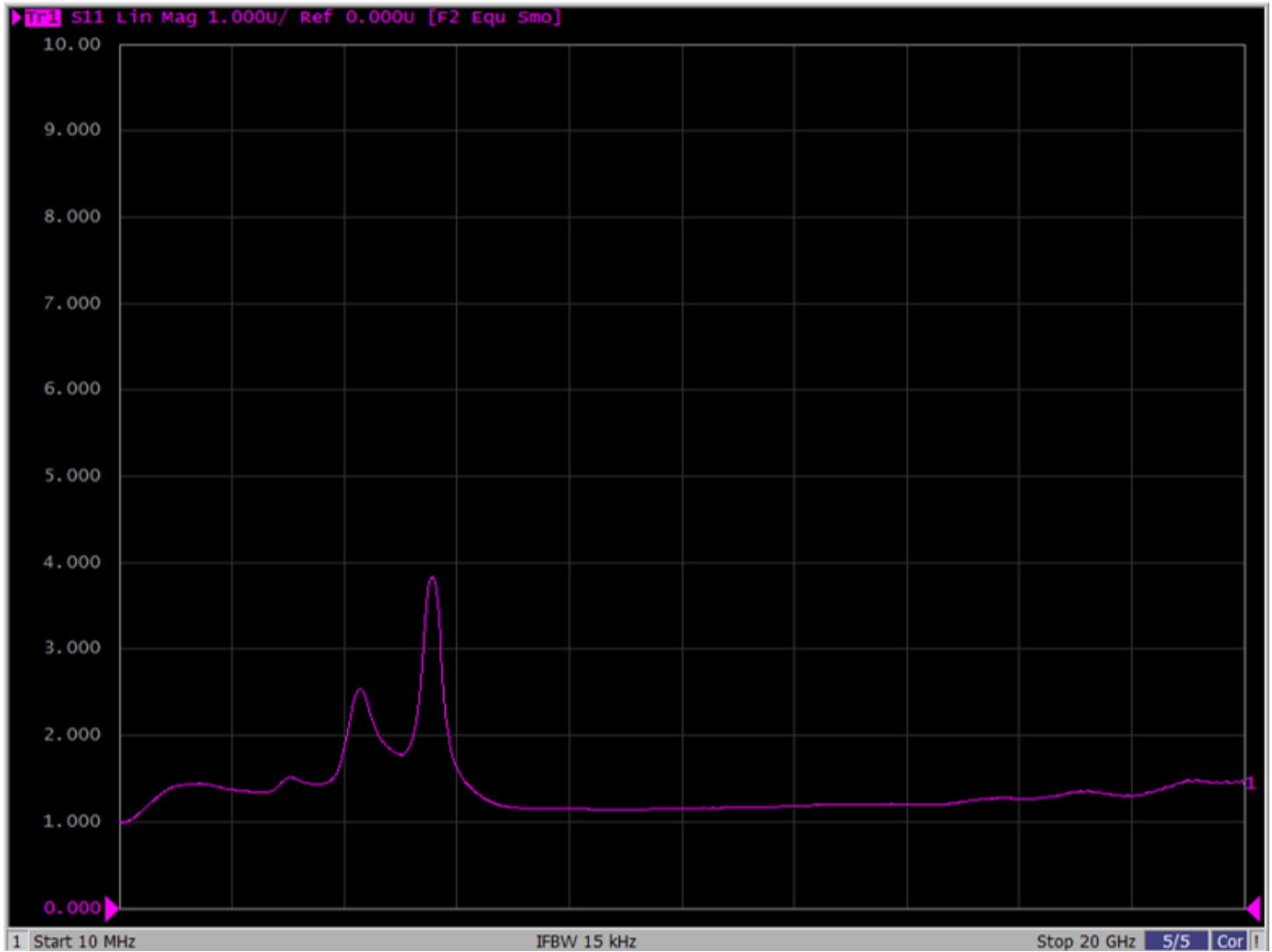

Note: Mu factor  $\geq 1.0$  implies unconditional stability.

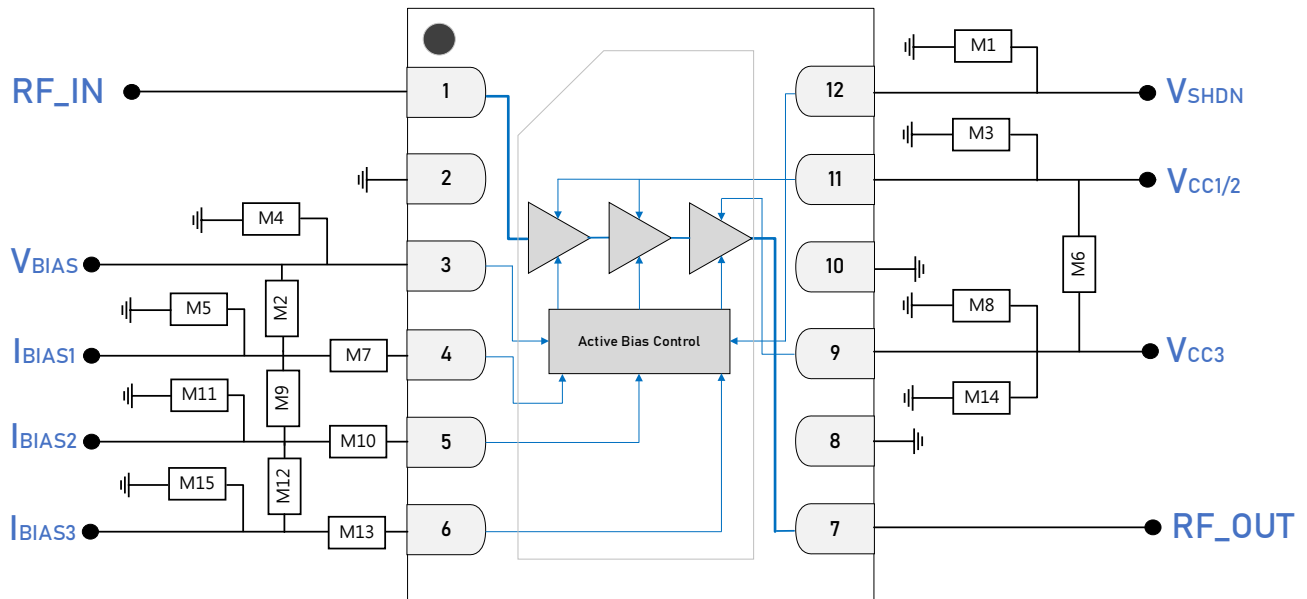

GRF5847 Standard Evaluation Board Schematic

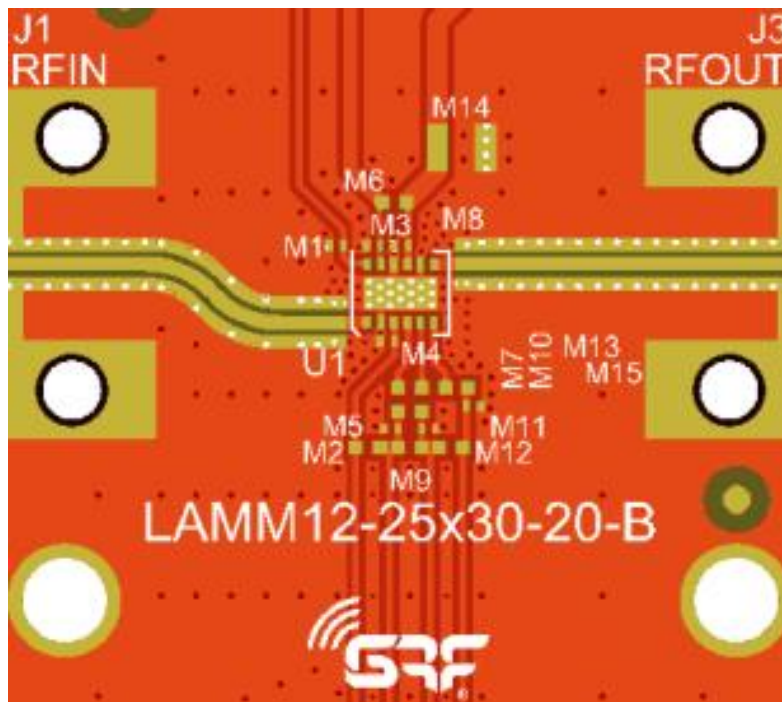

GRF5847 Evaluation Board Assembly Diagram

**GRF5847 Evaluation Board Assembly Diagram Reference: 4.4 to 5.2 GHz Tune**

Component	Type	Manufacturer	Family	Value	Package Size	Substitution
M1	Capacitor	Murata	GRM	220 pF	0201	ok
M2, M9, M12	Resistor (jumper)	Various	5%	0 $\Omega$	0402	ok
M3, M4, M8	Capacitor	Murata	GRM	0.1 $\mu$ F	0201	ok
M5, M6, M11, M15	DNP					
M7	Resistor	Various	1%	1.3 k $\Omega$	0402	ok
M10	Resistor	Various	1%	806 $\Omega$	0402	ok
M13	Resistor	Various	1%	590 $\Omega$	0402	ok
M14	Capacitor	Kemet	T529	22 $\mu$ F	0805	ok
Evaluation Board	LAMM12-25x30-20-B					

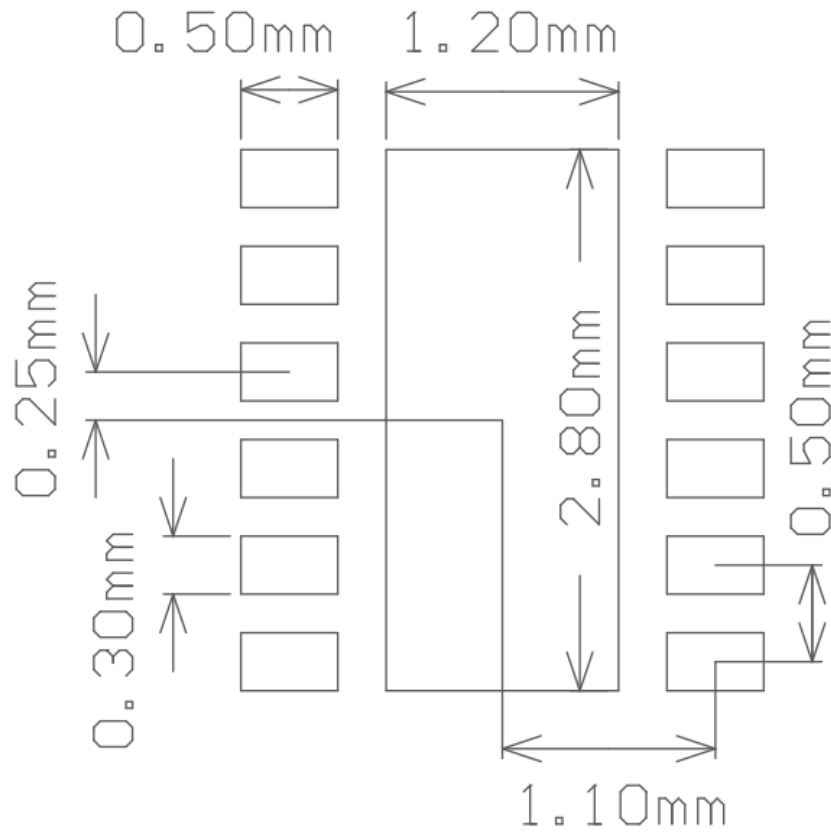

2.5 x 3.0 mm LAMM-12 Suggested PCB Footprint (Top View)

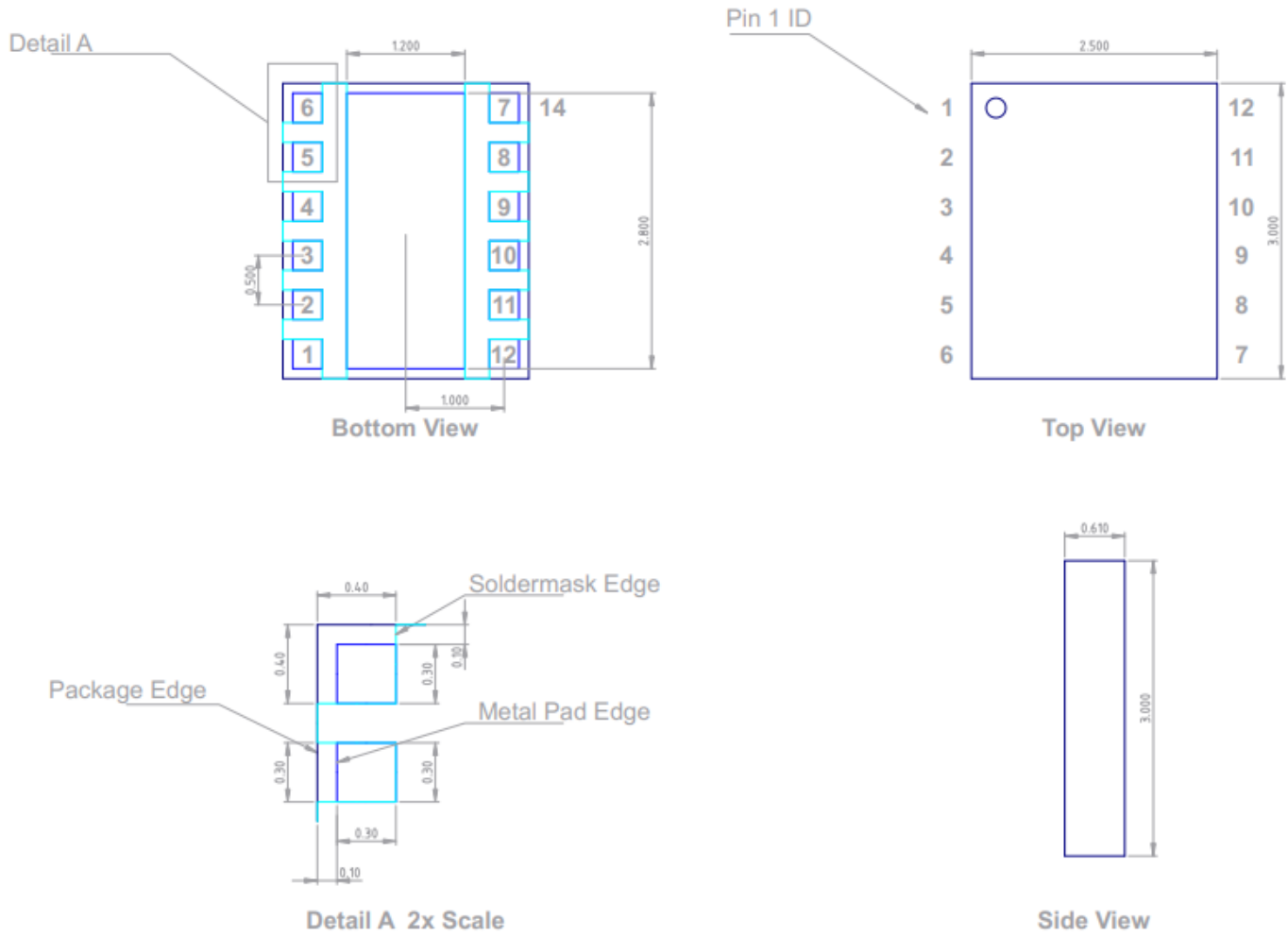

**LAMM12 2.5x3.0mm**  
Dimensions in millimeters

**2.5 x 3.0 mm LAMM-12 Package Dimensions**

### Package Marking Diagram



- Line 1: "YY" = YEAR. "WW" = WORK WEEK the device was assembled.
- Line 2: "XXXX" = Device PART NUMBER.

### Tape and Reel Information

Guerrilla RF's tape and reel specification complies with Electronic Industries Alliance (EIA) standards for "Embossed Carrier Tape of Surface Mount Components for Automatic Handling" (reference EIA-481). See the following page for the Tape and Reel Specification and Device Package Information table, which includes units per reel.

Devices are loaded with pins down into the carrier pocket with protective cover tape and reeled onto a plastic reel. Each reel is packaged in a cardboard box. There are product labels on the reel, the protective ESD bag and the outside surface of the box.

For the Tape and Reel Reference Table, please refer to: [Package Manufacturing Information | Guerrilla RF \(guerrilla-rf.com\)](http://www.guerrilla-rf.com)

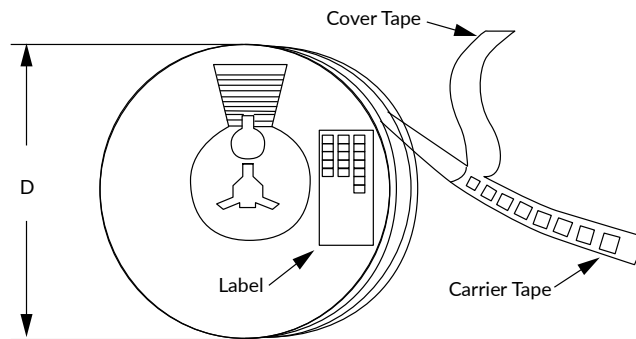

Tape and Reel Packaging with Reel Diameter Noted (D)

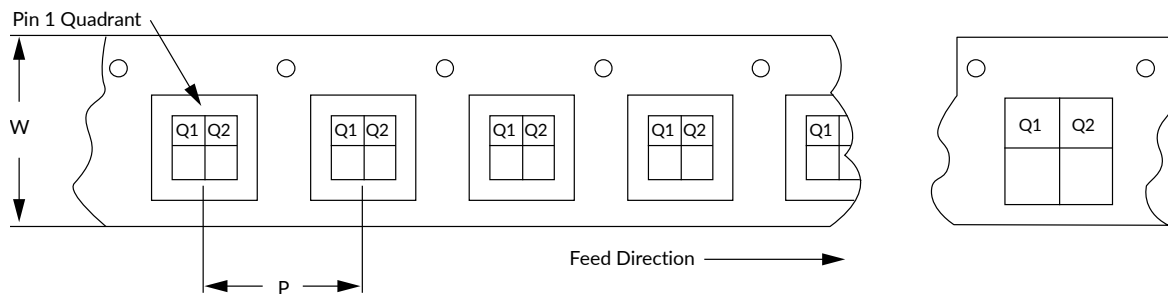

Carrier Tape Width (W), Pitch (P), Feed Direction and Pin 1 Quadrant Information



## Revision History

Revision Date	Description of Change
September 5, 2024	Advance Data Sheet.
October 21, 2024	Preliminary Data Sheet.
January 15, 2025	Changed Mean Time to Failure (MTTF) to TBD.
November 7, 2025	Changed MSL Rating from TBD to 5A.



### Data Sheet Classifications

Data Sheet Status	Notes
Advance	S-Parameter and NF data based on EM simulations for the fully packaged device using foundry-supplied transistor S-Parameters. Linearity estimates based on device size, bias condition and experience with related devices.
Preliminary	All data based on limited evaluation board measurements taken within the Guerrilla RF Applications Lab. All parametric values are subject to change pending the collection of additional data.
Release Ø	All data based on measurements taken with <i>production-released</i> material. TYP values are based on a combination of ATE and bench-level measurements, with MIN/MAX limits defined using <i>modelled estimates</i> that account for part-to-part variations and expected process spreads. Although unlikely, future refinements to the TYP/MIN/MAX values may be in order as multiple lots are processed through the factory.
Release A-Z	All data based on measurements taken with production-released material <i>derived from multiple lots which have been fabricated over an extended period of time</i> . MIN/MAX limits may be refined over previous releases as more statistically significant data is collected to account for process spreads.

Information in this data sheet is specific to the Guerrilla RF, Inc. ("Guerrilla RF") product identified.

This data sheet, including the information contained in it, is provided by Guerrilla RF as a service to its customers and may be used for informational purposes only by the customer. Guerrilla RF assumes no responsibility for errors or omissions on this data sheet or the information contained herein. Information provided is believed to be accurate and reliable, however, no responsibility is assumed by Guerrilla RF for its use, nor for any infringement of patents, or other rights of third parties, resulting from its use. Guerrilla RF assumes no liability for any data sheet, data sheet information, materials, products, product information, or other information provided hereunder, including the sale, distribution, reproduction or use of Guerrilla RF products, information or materials.

No license, whether express, implied, by estoppel, by implication or otherwise is granted by this data sheet for any intellectual property of Guerrilla RF, or any third party, including without limitation, patents, patent rights, copyrights, trademarks and trade secrets. All rights are reserved by Guerrilla RF.

All information herein, products, product information, data sheets, and data sheet information are subject to change and availability without notice. Guerrilla RF reserves the right to change component circuitry, recommended application circuitry and specifications at any time without prior notice. Guerrilla RF may further change its data sheet, product information, documentation, products, services, specifications or product descriptions at any time, without notice. Guerrilla RF makes no commitment to update any materials or information and shall have no responsibility whatsoever for conflicts, incompatibilities, or other difficulties arising from any future changes.

GUERRILLA RF INFORMATION, PRODUCTS, PRODUCT INFORMATION, DATA SHEETS AND DATA SHEET INFORMATION ARE PROVIDED "AS IS" AND WITHOUT WARRANTY OF ANY KIND, WHETHER EXPRESS, IMPLIED, STATUTORY, OR OTHERWISE, INCLUDING FITNESS FOR A PARTICULAR PURPOSE OR USE, MERCHANTABILITY, PERFORMANCE, QUALITY OR NON-INFRINGEMENT OF ANY INTELLECTUAL PROPERTY RIGHT; ALL SUCH WARRANTIES ARE HEREBY EXPRESSLY DISCLAIMED. GUERRILLA RF DOES NOT WARRANT THE ACCURACY OR COMPLETENESS OF THE INFORMATION, TEXT, GRAPHICS OR OTHER ITEMS CONTAINED WITHIN THESE MATERIALS. GUERRILLA RF SHALL NOT BE LIABLE FOR ANY DAMAGES, INCLUDING BUT NOT LIMITED TO ANY SPECIAL, INDIRECT, INCIDENTAL, STATUTORY, OR CONSEQUENTIAL DAMAGES, INCLUDING WITHOUT LIMITATION, LOST REVENUES OR LOST PROFITS THAT MAY RESULT FROM THE USE OF THE MATERIALS OR INFORMATION, WHETHER OR NOT THE RECIPIENT OF MATERIALS HAS BEEN ADVISED OF THE POSSIBILITY OF SUCH DAMAGE.

Customers are solely responsible for their use of Guerrilla RF products in the Customer's products and applications or in ways which deviate from Guerrilla RF's published specifications, either intentionally or as a result of design defects, errors, or operation of products outside of published parameters or design specifications. Customers should include design and operating safeguards to minimize these and other risks. Guerrilla RF assumes no liability or responsibility for applications assistance, customer product design, or damage to any equipment resulting from the use of Guerrilla RF products outside of stated published specifications or parameters.