



TAOGLAS®



Datasheet

Accura UWCCP.01

Part No:
UWCCP.01

Description:

6~7 GHz Ultra-Wideband (UWB), Embedded Linear Polarized, SMT Chip Antenna

Features:

SMD UWB Chip Antenna

For European and USA UWB Applications In Channels 5

Uses

- Centimeter Level Positioning
- Indoor Positioning
- Follow Me Autonomous Positioning
- Time of Arrival (TOA) Applications
- Angle of Arrival (AOA) Applications
- Remote Keyless Entry (RKE) Security

Frequency: 6.0 – 7.0 GHz

Dims: 14.3mm*8.35mm*2mm

RoHS and REACH compliant

1. Introduction	3
2. Specifications	5
3. Antenna Characteristics	6
4. Radiation Patterns	11
5. Mechanical Drawing	13
6. Antenna Integration Guide	14
7. Packaging	22
8. Solder Reflow Profile	23
9. Application Note	24
Changelog	31

Taoglas makes no warranties based on the accuracy or completeness of the contents of this document and reserves the right to make changes to specifications and product descriptions at any time without notice. Taoglas reserves all rights to this document and the information contained herein. Reproduction, use or disclosure to third parties without express permission is strictly prohibited.



1. Introduction



The UWCCP.01 chip antenna, at 14.3*8.35*2 mm, is a small form factor embedded Ultra-Wideband (UWB) antenna with high efficiencies across the pulsed UWB communications operational channel 5 (6.25 GHz – 6.75 GHz). It is linear polarized and hence very suitable for use in mobile tags in standard Time of Arrival (ToA) and advanced Angle of Arrival (AoA) localization systems. It is mounted to a PCB via standard SMT reflow process.

The UWCCP.01 antenna is a durable ceramic antenna that has a peak gain of 6.5dBi, an efficiency of more than 70% across the channel 5 and is designed to be mounted directly onto a PCB. It is an ideal choice for any device maker that needs to keep manufacturing costs down over the lifetime of a product. Like all such antennas, care should be taken to mount the antenna at least 3mm from metal components or surfaces, and ideally 5mm for best radiation efficiency.

Ultra-Wideband (also known as UWB) is a low power digital wireless technology for transmitting large amounts of digital data over a wide spectrum of frequency bands typically spanning more than 500MHz with very low power for short distances.

The low power requirements of UWB mean increased battery life of sensors and tags leading to reduction in overall operational costs.

Besides the chip antenna line, Taoglas has also developed innovative and new-to-market flexible embedded UWB antennas designed for seamless integration on plastics and using highly flexible micro-coaxial cable mounting while achieving high performance where space is limited. Taoglas UWB antennas have been designed for use with the recently launched Decawave ScenSor DW1000 module and are also compatible with any other UWB sensor modules on the market.

1.1 Applications of Pulsed UWB antenna Technology

- **Radar** - These short-pulsed antennas provide very fine range resolution and precision distance and positioning measurement capabilities. UWB signals enable inexpensive high definition radar antennas which find use in automotive sensors, smart airbags and precision surveying applications amongst many others.
- **Home Network Connectivity** - Smart home and entertainment systems can take advantage of high data rates for streaming high quality audio and video contents in real time for consumer electronics and computing within a home environment.
- **Position location & Tracking** - UWB antennas also find use in Position Location and Tracking applications such as locating patients in case of critical condition, hikers injured in remote areas, tracking cars, and managing a variety of goods in a big shopping malls. UWB offers better noise immunity and better accuracy to within a few cm compared to current localization technologies such as Assisted GPS for Indoors, Wi-Fi and cellular which are at best able to offer meter level precision. Tethered Indoor Positioning UWB systems that measure the angles of arrival of ultra-wideband (UWB) radio signals perform triangulation by using multiple sensors to communicate with a tag device.



2. Specifications

Electrical	
STANDARD	EU UWB
	USA UWB Channel 5
Operation Frequency (GHz)	6.24-6.74
Return Loss (dB)	<-8
Efficiency (%)	80
Peak Gain (dBi)	6.5
Max Axial Ratio (dB)	6
Radiation Properties	Omnidirectional
Polarization	Linear
Impedance (Ohms)	50
Max input Power (Watts)	10
Mechanical	
Dimension	14.8mm x 8.4mm x 2mm
Material	Ceramic
Environmental	
Operation Temperature	-40°C to 85°C
Storage Temperature	-40°C to 85°C
Moisture Sensitivity Level (MSL)	3 (168 Hours)
Humidity	40% to 90%

Results obtained for antenna on Standard Evaluation Board size 16 mm x 12 mm,
with 16 mm x 4.2 mm ground plane.

3. Antenna Characteristics

3.1 Return Loss

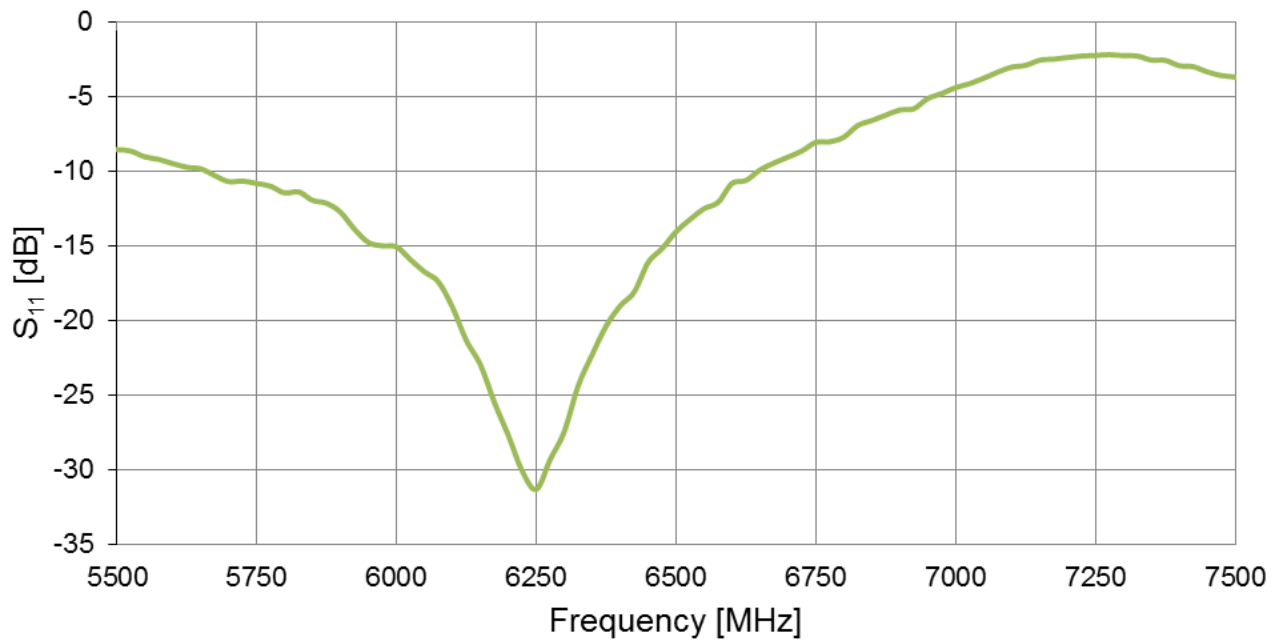

3.2 VSWR

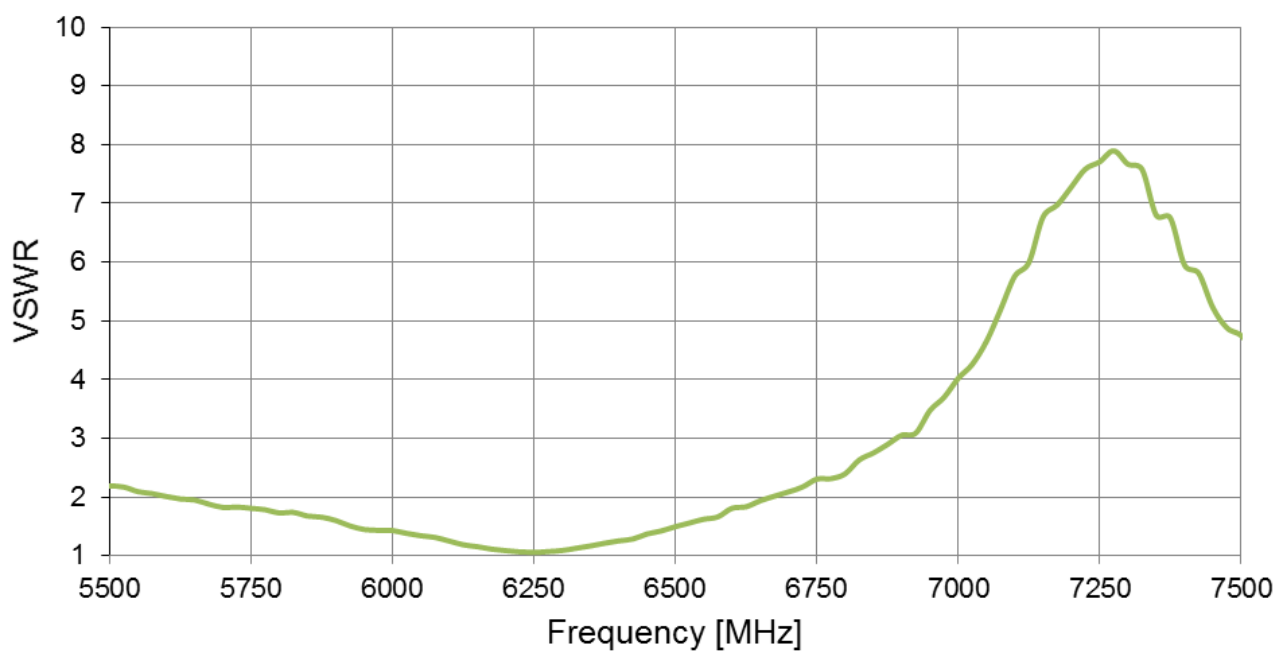

3.3 Efficiency [%]

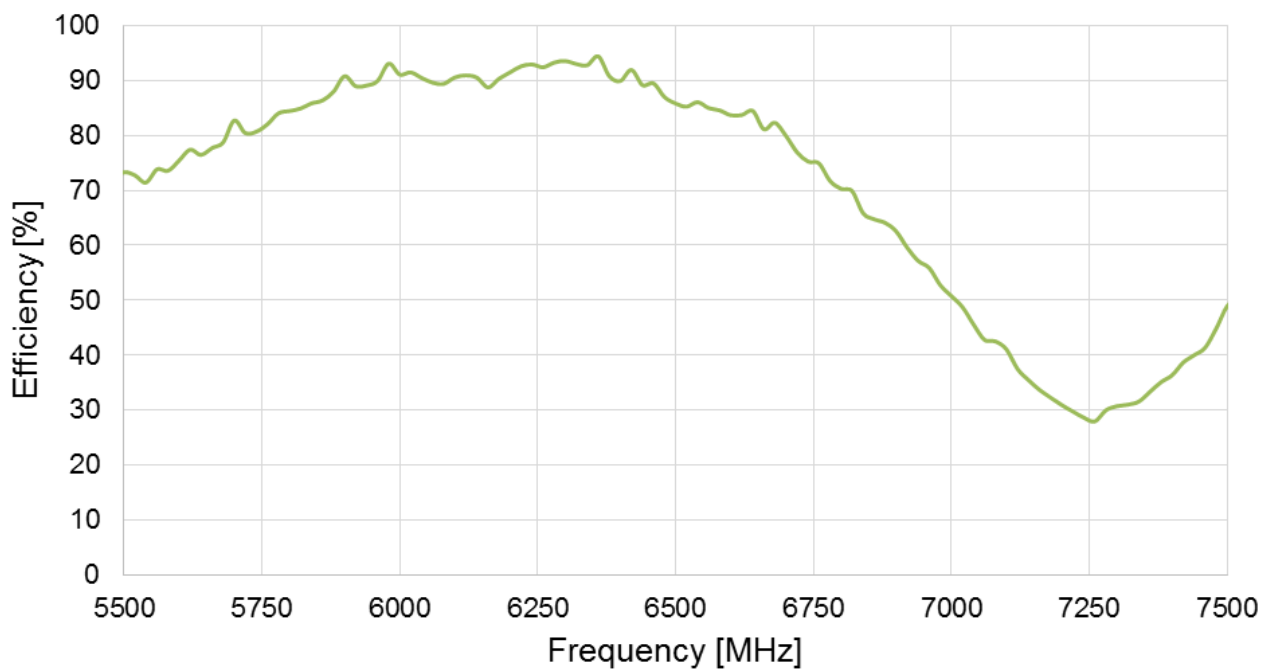

3.4 Peak Gain

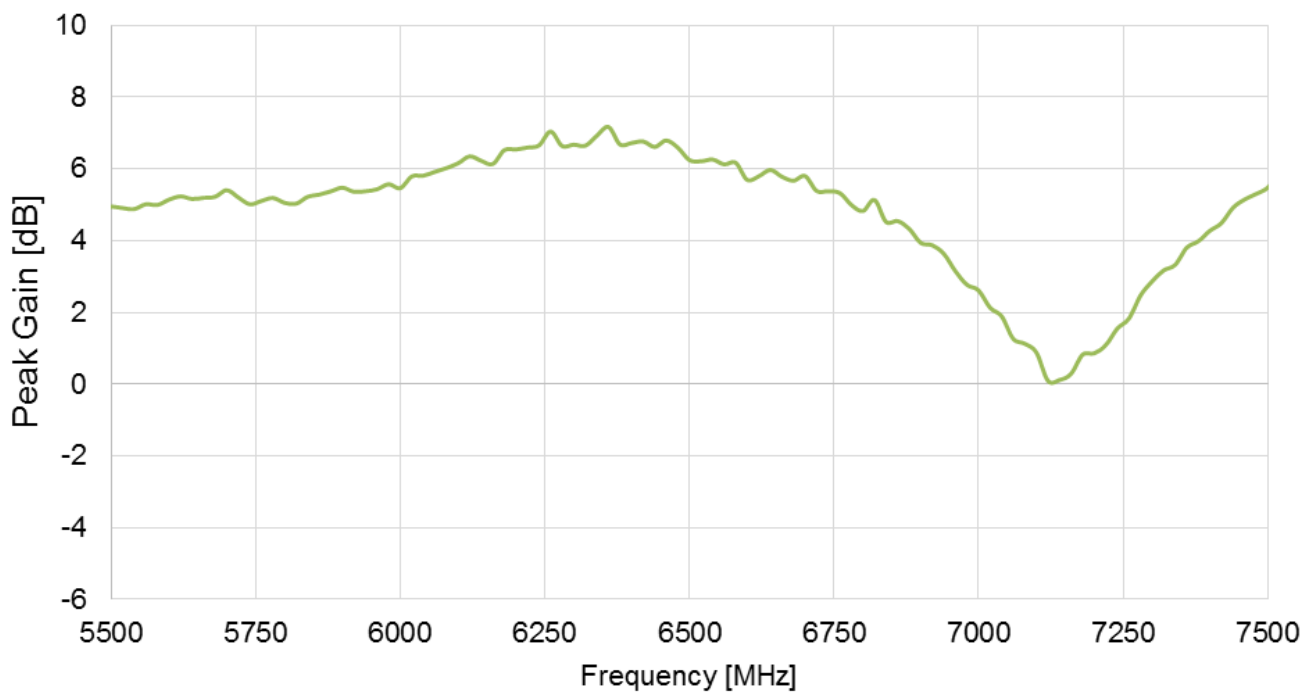

3.5 Average Gain

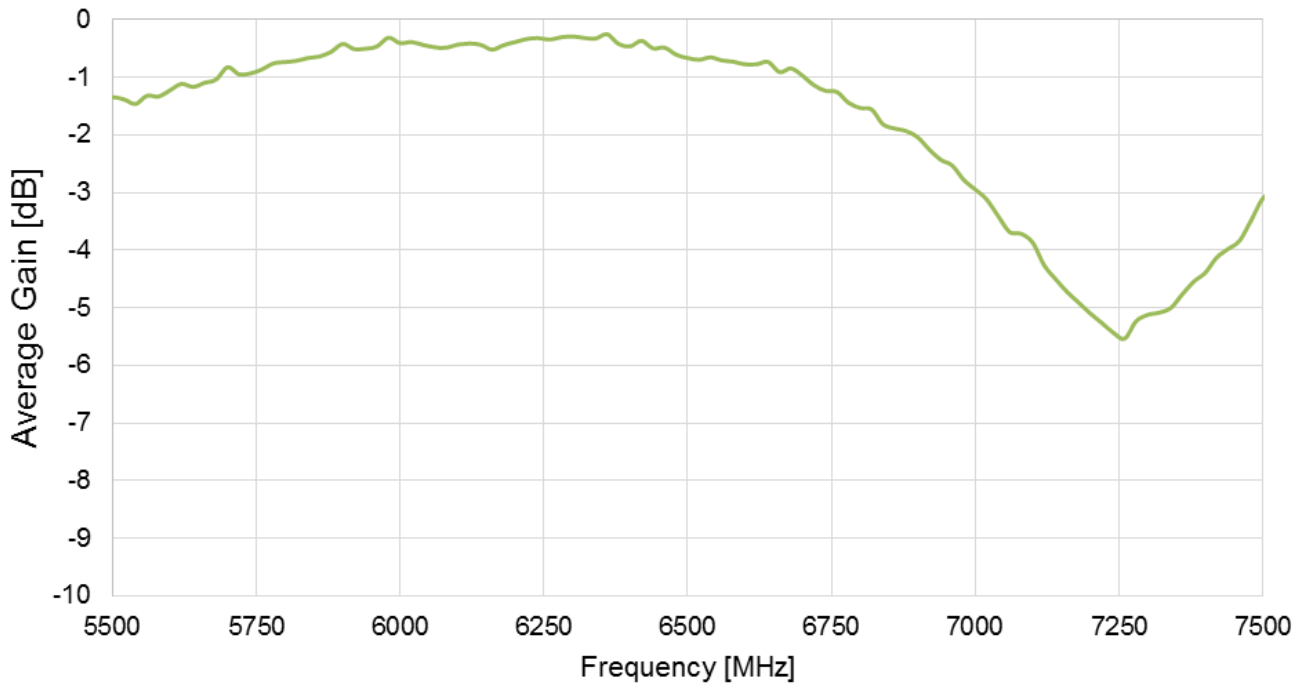

3.6 Axial Ratio

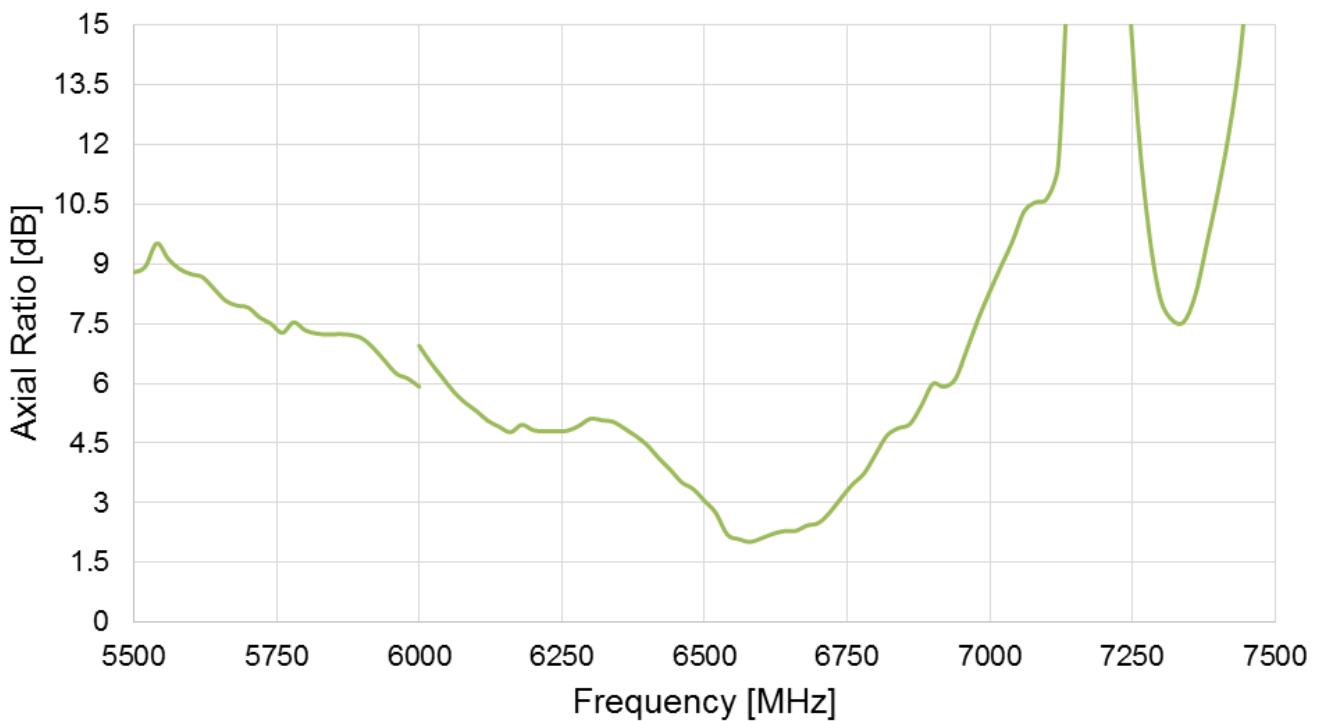

*Note: Axial ratio measurements are done with 2 different physical systems (< 6 GHz and > 6 GHz) therefore a discontinuity appears at 6 GHz

3.7 Group Delay (XY Plane) at 6.5GHz

The Total System Group Delay (in seconds) is the total time delay or transmit time of the amplitude envelopes of the various sinusoidal components of UWB signals through a device or link budget system. Effectively it is the propagation delay in transmitting antenna (Tx), propagation channel (Ch), and in receiving antenna (Rx) summed together.

An even more important parameter is the Group Delay Variation over Theta Angle from an average constant group delay. The group delay ripple is used to quantify this deviation. Ultimately, deviations from a maximally flat or constant group delay represent distortions in the output signal which is undesirable. A group delay variation of 100-150ps or less is considered very good for UWB system implementation.

3.8 Group Delay Vs Frequency

The group delay was simulated for two antennas placed at a far-field distance of 1m distance. One of the antennas was kept stationary, while the other was rotated in 45° intervals.

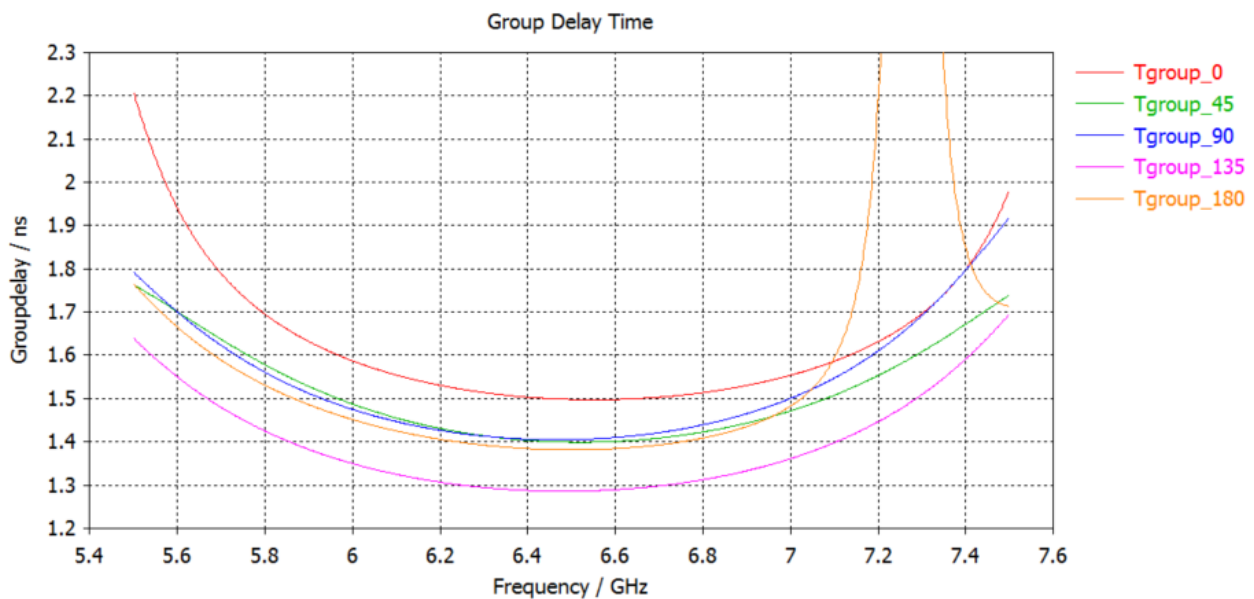

3.9 Group Delay Vs Theta at 6.5 GHz

The calculated Maximum difference between the highest value and the lowest Group Delay value is presented below. The UWCCP.01 antenna presents Group Delay variation smaller than 250 ps (slightly above benchmark but flat) from 6 GHz up to 7.1 GHz spanning UWB channels 5-7.

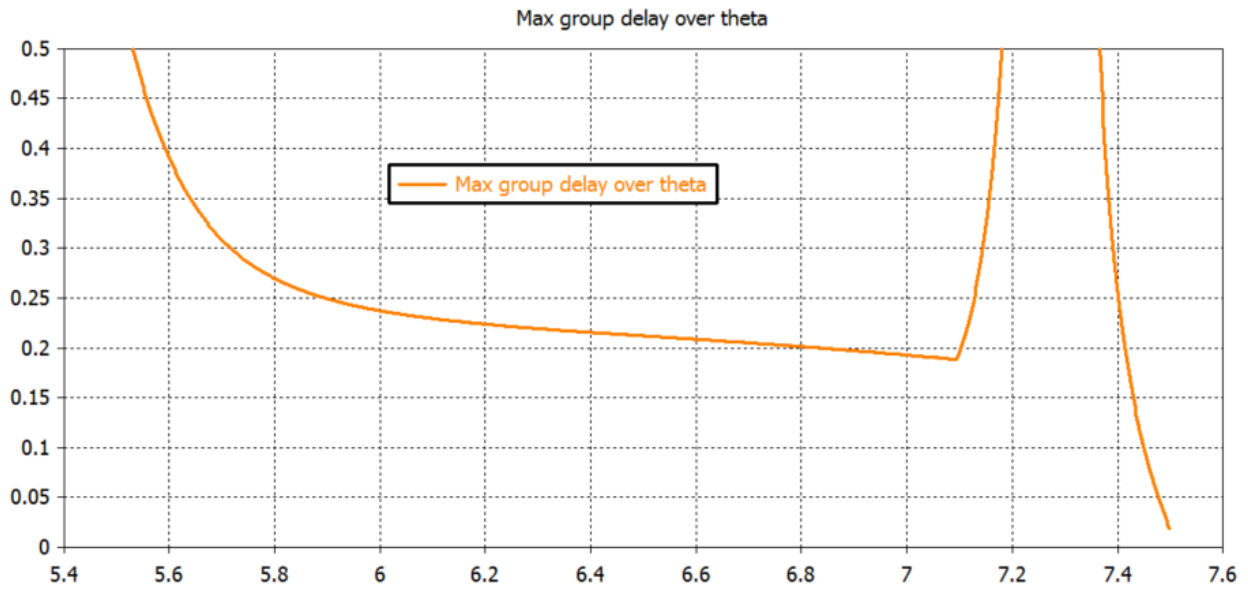

3.10 Fidelity Factor vs. Theta Angle

The fidelity is above 0.9 (benchmark value) for all Theta angles, therefore UWCCP.01 shows very good performance.

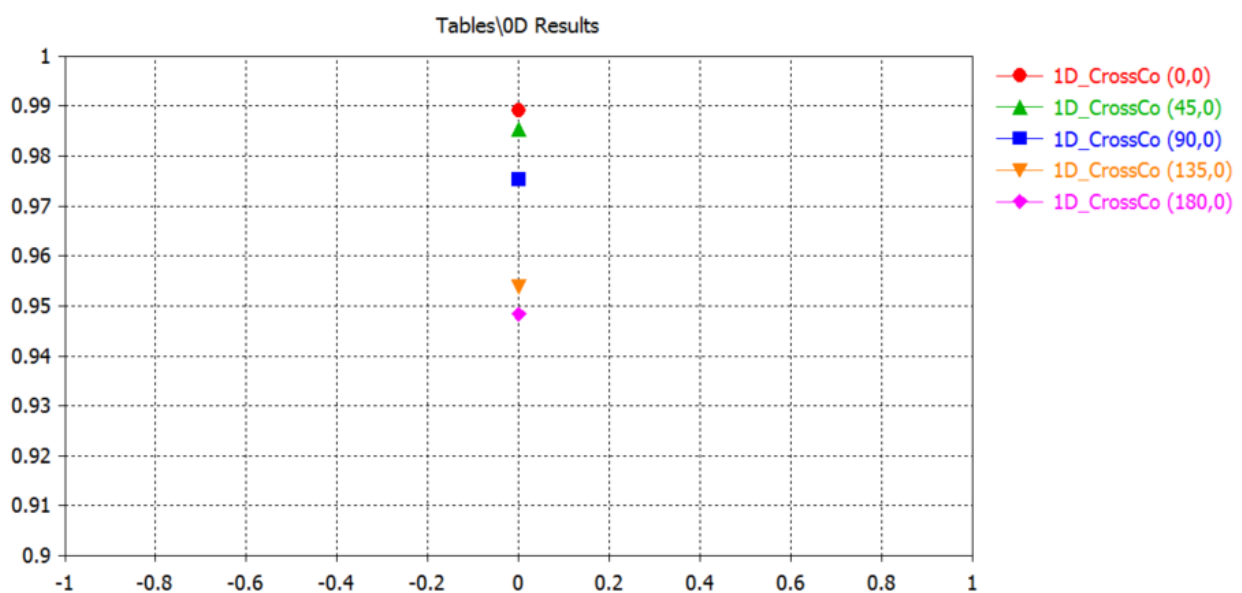

4. Radiation Patterns

4.1 Test Setup

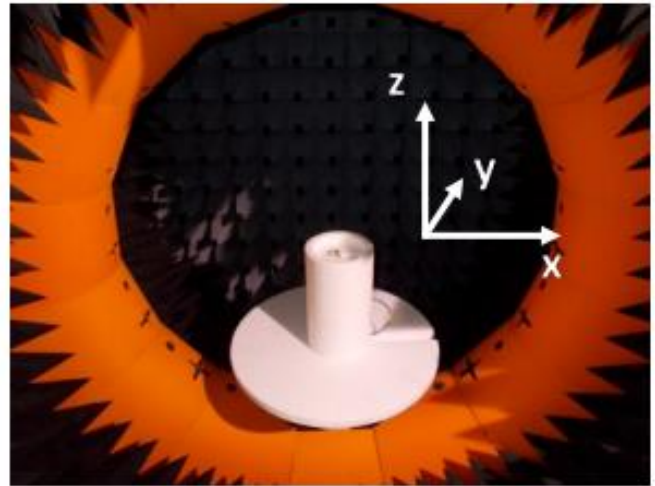
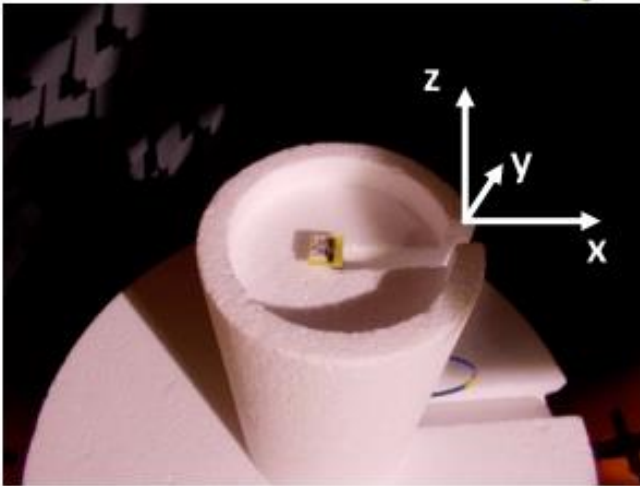

4.2 3D and 2D Radiation Patterns

6GHz

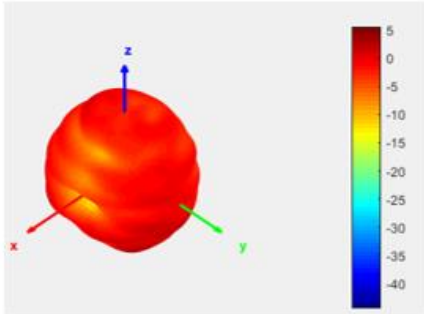

6.5GHz

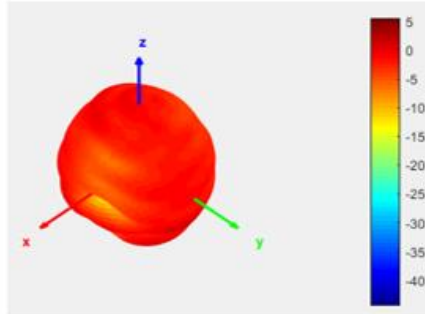

7GHz

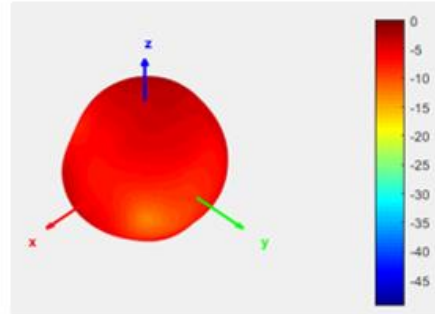

XY Plane

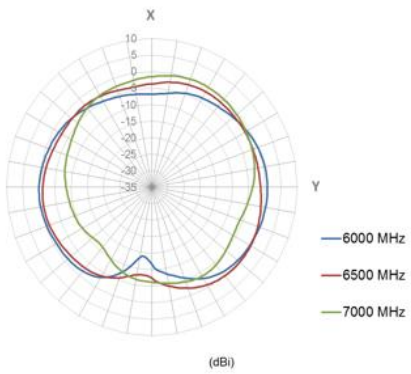

XZ Plane

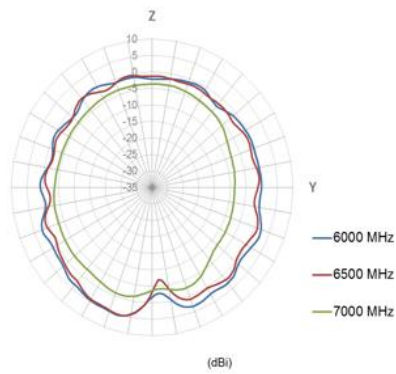

YZ Plane

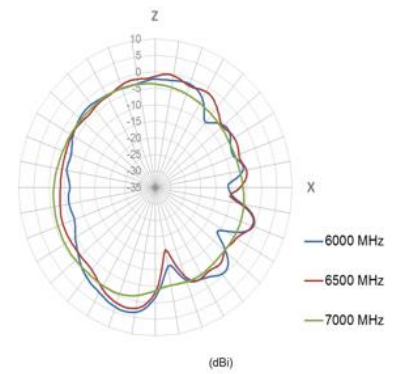

6. Antenna Integration Guide



6.1 Schematic Symbol and Pin Definition

The circuit symbol for the antenna is shown below. The antenna has 3 pins, all of which are functional.

Pin	Description
1	RF Feed
2,3	Ground

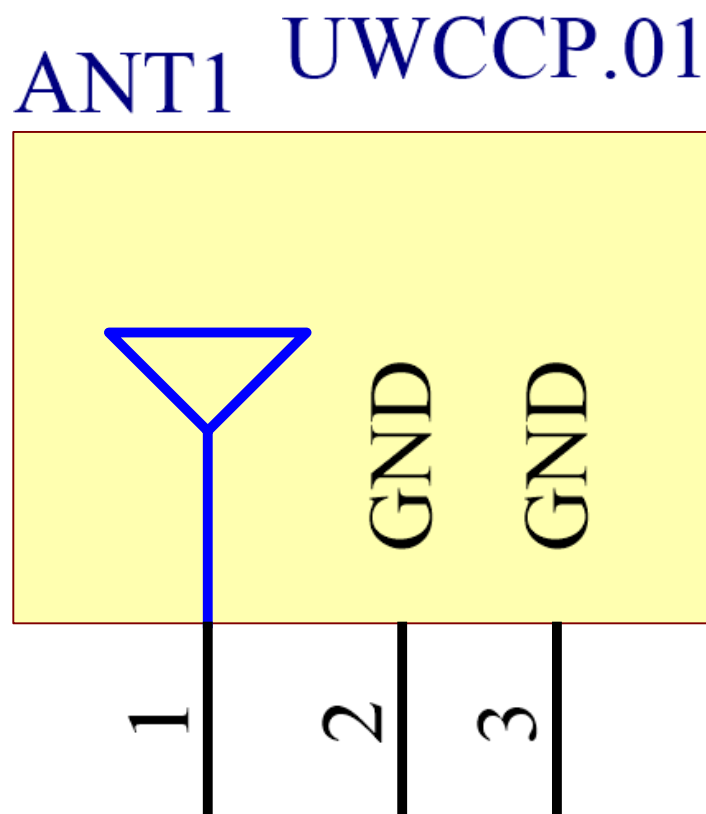

Please note you can download the CST and HFSS simulation files from the website here:

<https://www.taoglas.com/product/uwccp-01-67-ghz-uw-embedded-circular-polarized-smt-chip-antenna/>

6.2 Antenna Integration

The antenna should be placed in the centre at the top of the PCB. The top plated footprint around the pin should not be covered in solder mask so that the antenna pin is soldered to the PCB. No pin soldering is needed on the bottom side of the PCB. Please see application note in section 7 below.



6.3 PCB Layout

The footprint and clearance on the PCB must meet the antenna specification. An example of the PCB layout shows the antenna footprint with clearance.

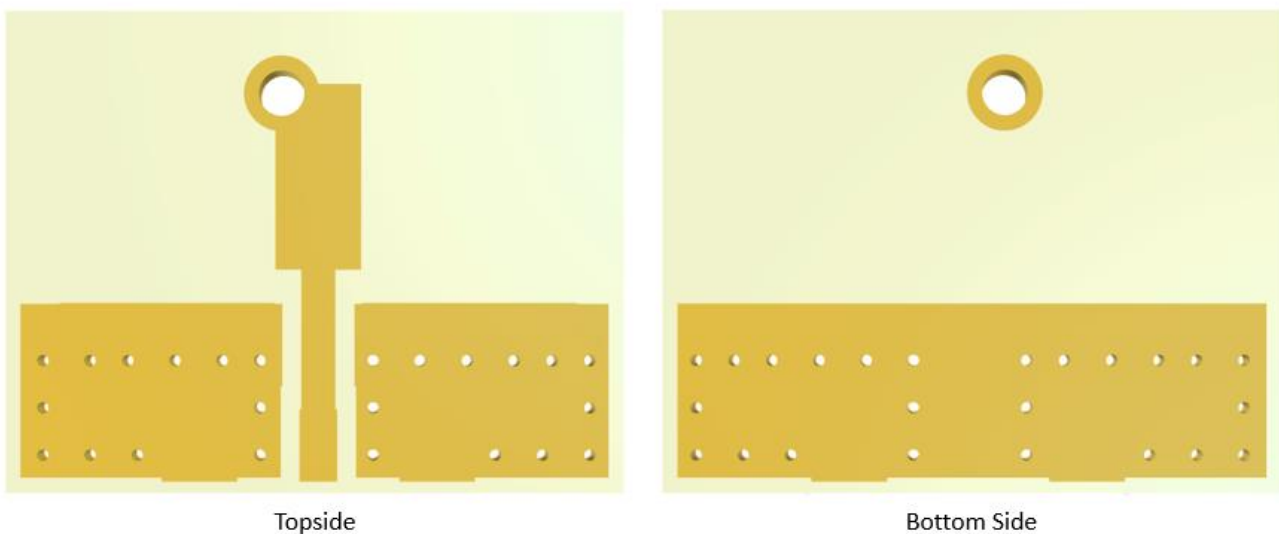

6.4 PCB Clearance

Below shows the antenna footprint and clearance through ALL layers on the PCB. Only the antenna pads and connections to feed are present within this clearance area (marked RED). This clearance area includes the bottom side and ALL internal layers on the PCB.

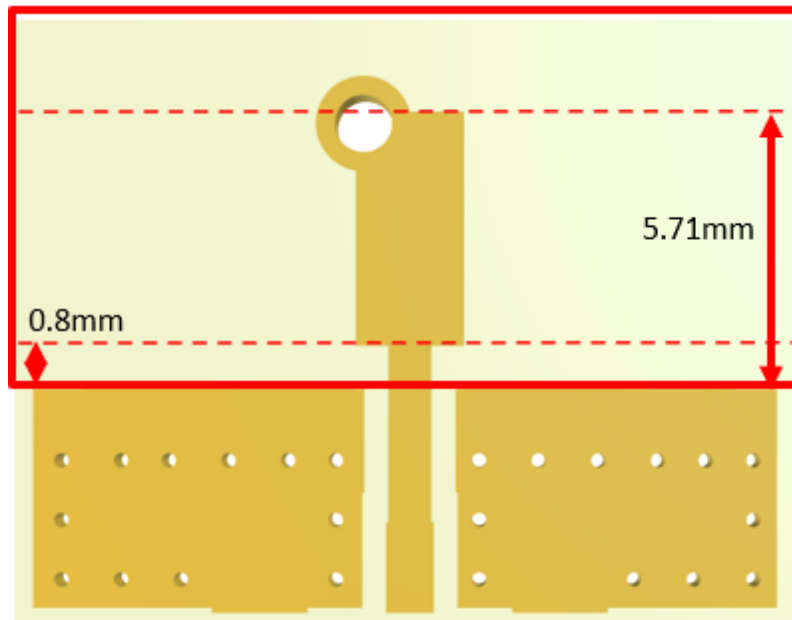

Top Side

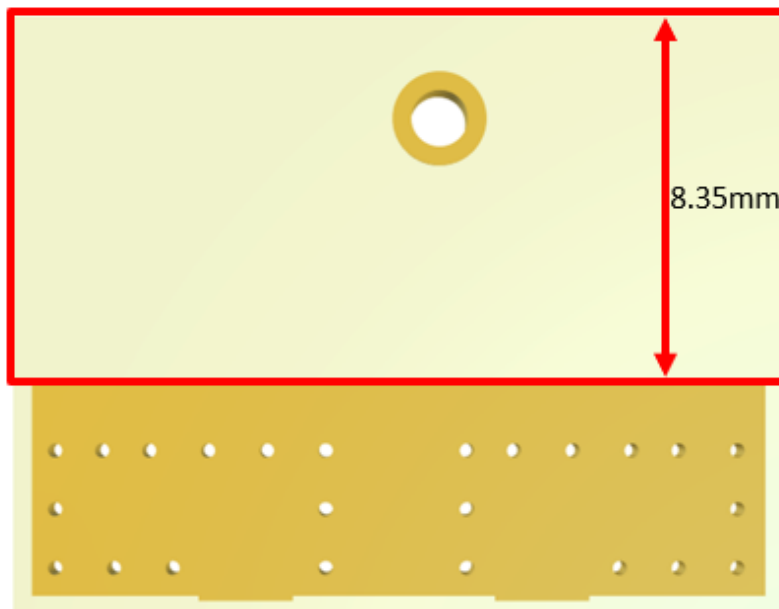

Bottom Side

6.5 Evaluation Board

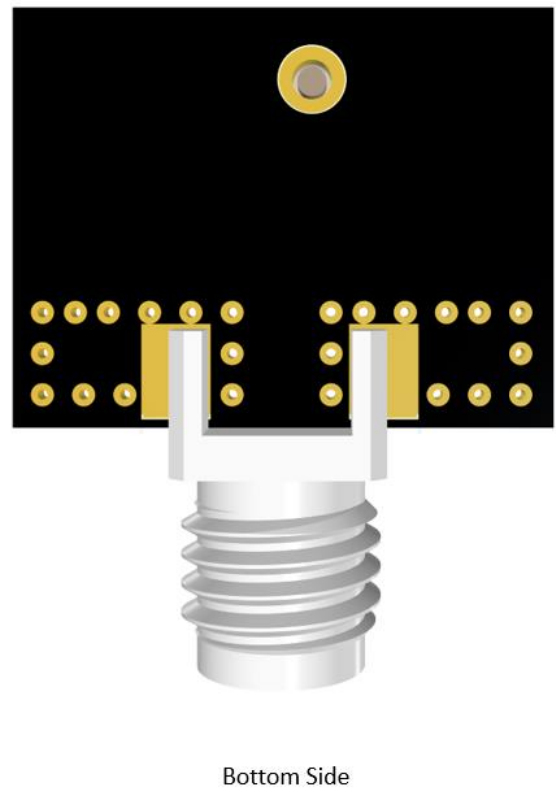
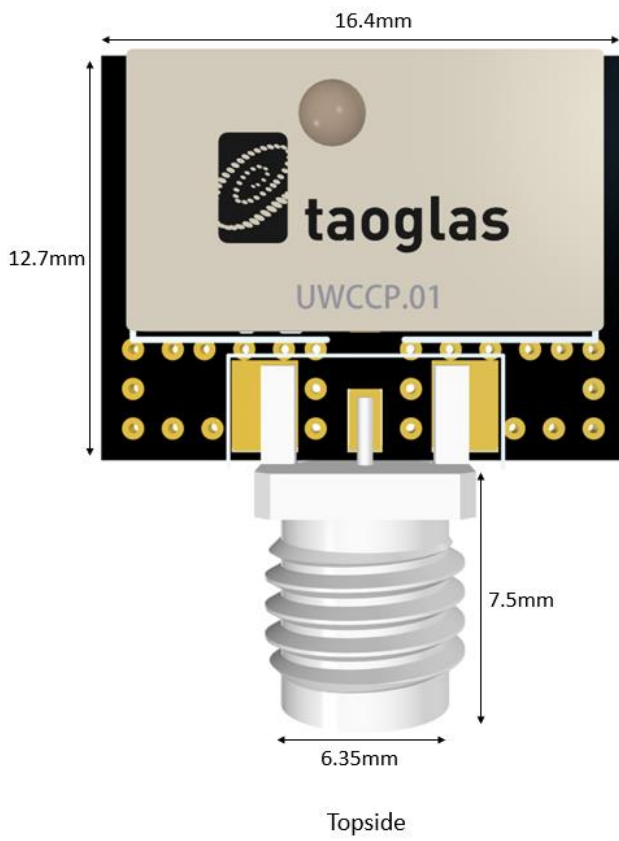

6.6 Evaluation Board Ground Plane Length



6.7 Clearance Study

A metal clearance study is also performed. A 5mm X 5mm X 2mm metal component is placed on different locations around the UWCCP.01 antenna as shown in the figure below. The component is either placed at 1mm or 3mm distance to the antenna.

The results show that components placed as close as 1 mm from the left, right, or top edge of the antenna will not significantly decrease performance. It is advised not to place components closer than 1 mm from the antenna.

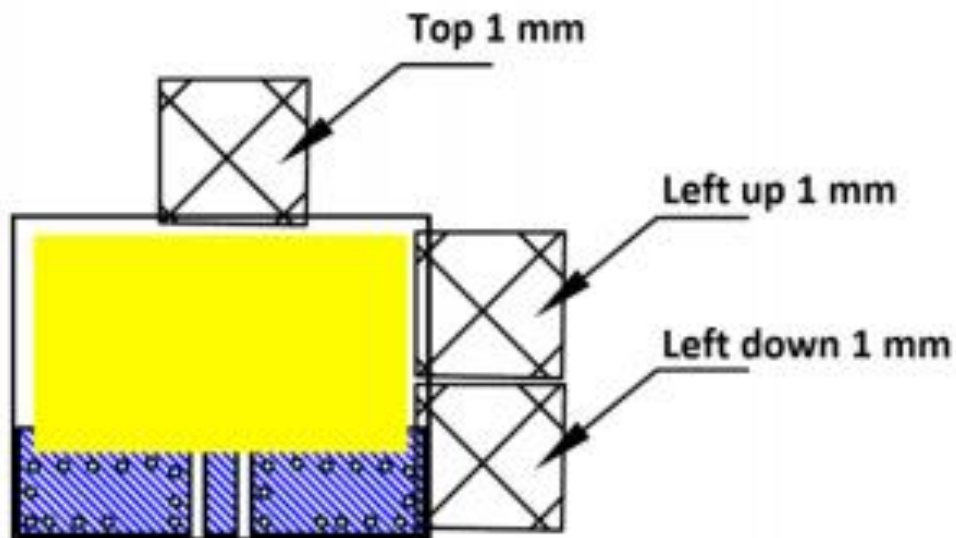

6.8 Footprint

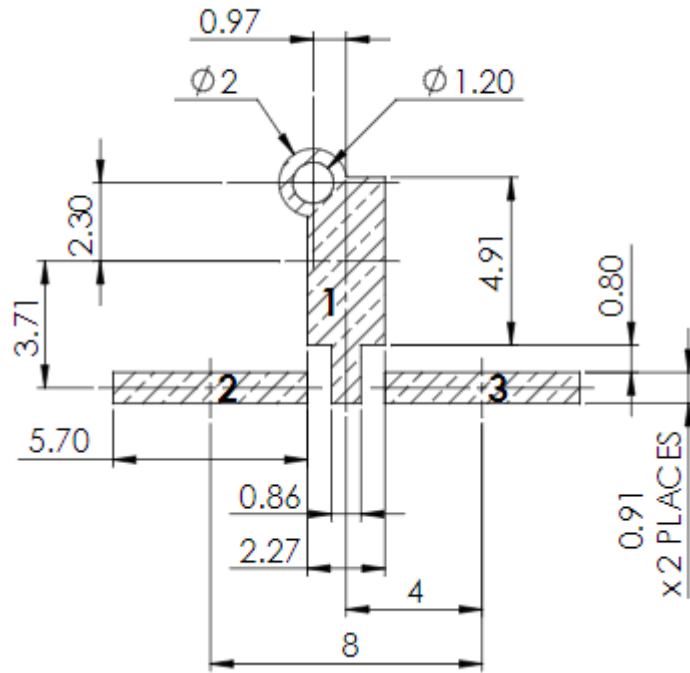

PIN:	DESCRIPTION:
1	Feed (50 ohm)
2,3	GND

7. Packaging

700 pcs UWCCP.01 per reel
 Dimensions - Ø330*20.4mm

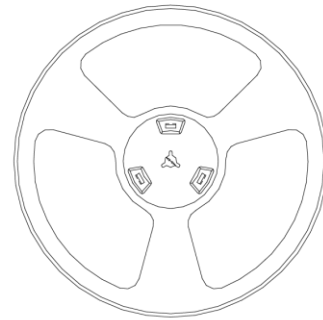

700 pcs UWCCP.01 / 1 Reel in small box
 Dimensions - 350*340*47mm

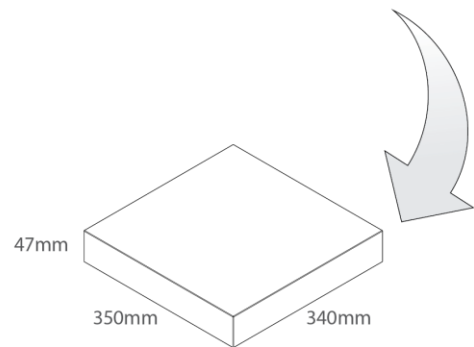

5 small boxes, 3500 pcs in one carton
 Carton Dimensions - 370*370*300mm

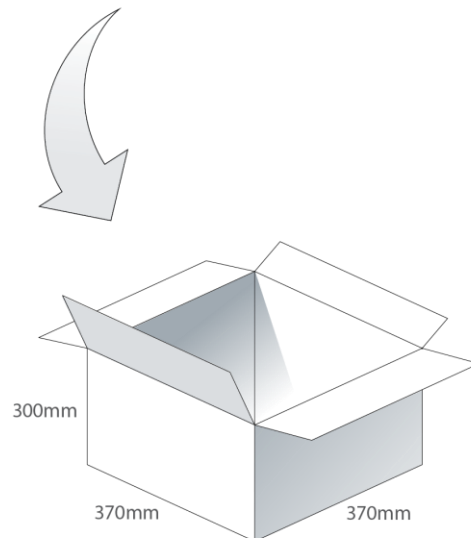

8. Solder Reflow Profile

The UWCCP.01 can be assembled by following the recommended soldering temperatures are as follows:

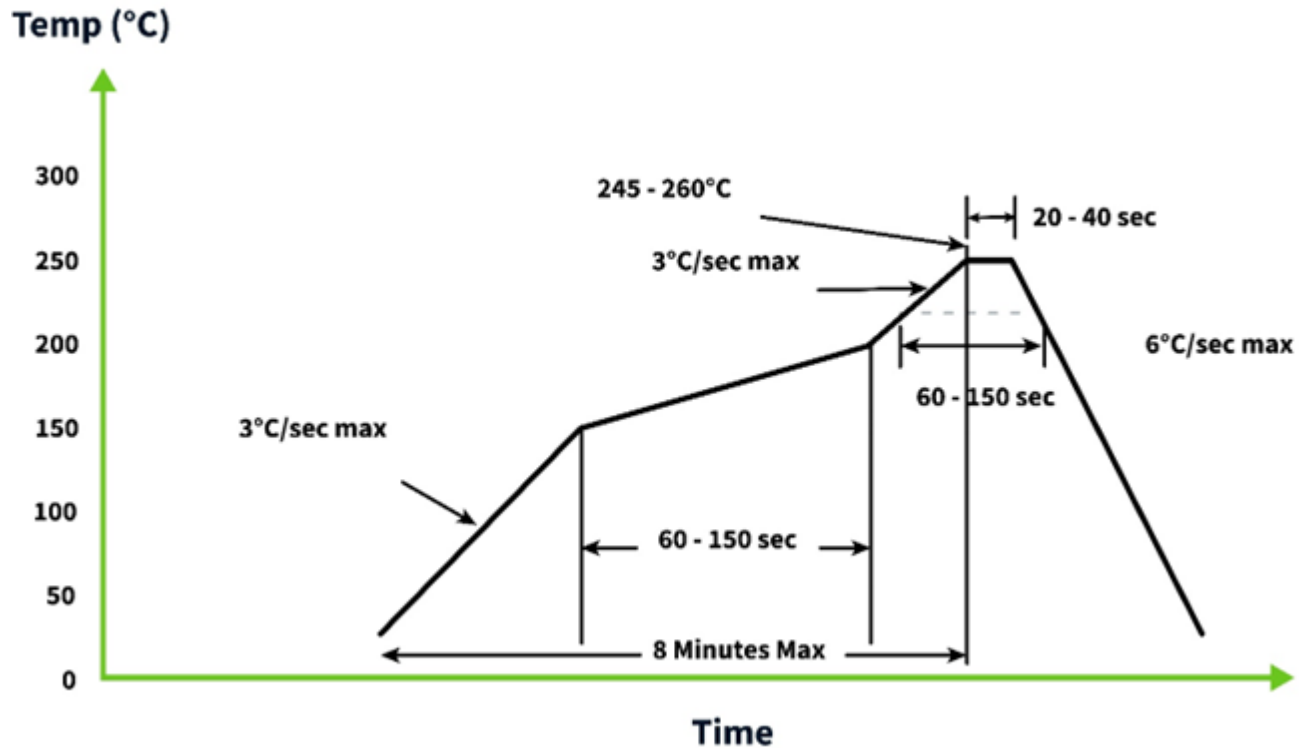

*Temperatures listed within a tolerance of +/- 10° C

Smaller components are typically mounted on the first pass, however, we do advise mounting the UWCCP.01 when placing larger components on the board during subsequent reflows.

Note: Soldering flux classified ROL0 under IPC J-STD-004 is recommended.

9. Application Note

9.1 Recommended Placement and Ground Plane Size

The recommended ground plane dimensions and antenna landing pattern are shown below. The antenna should be placed in the middle of the ground plane. The top plated footprint around the pin should be covered in solder mask so that the antenna pin is soldered to the PCB. No pin soldering is needed on the bottom side of the PCB.

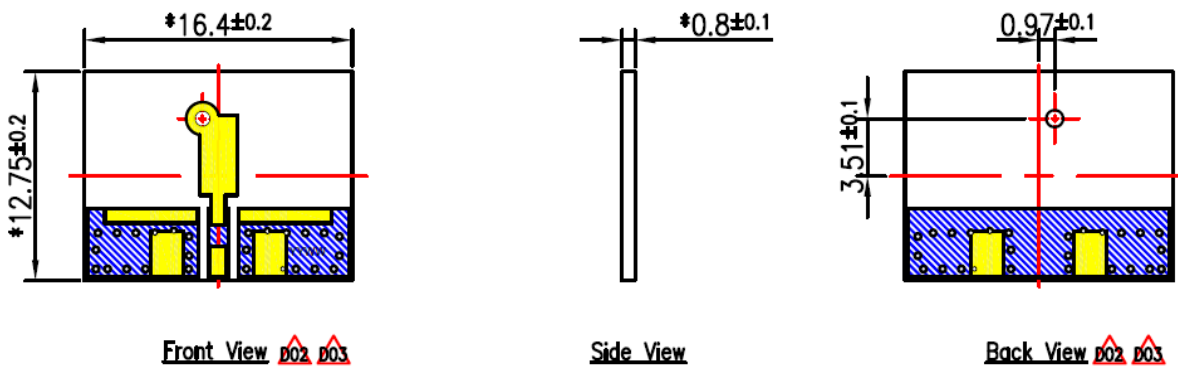

Evaluation Board

Copper Lay  Plated Lay 

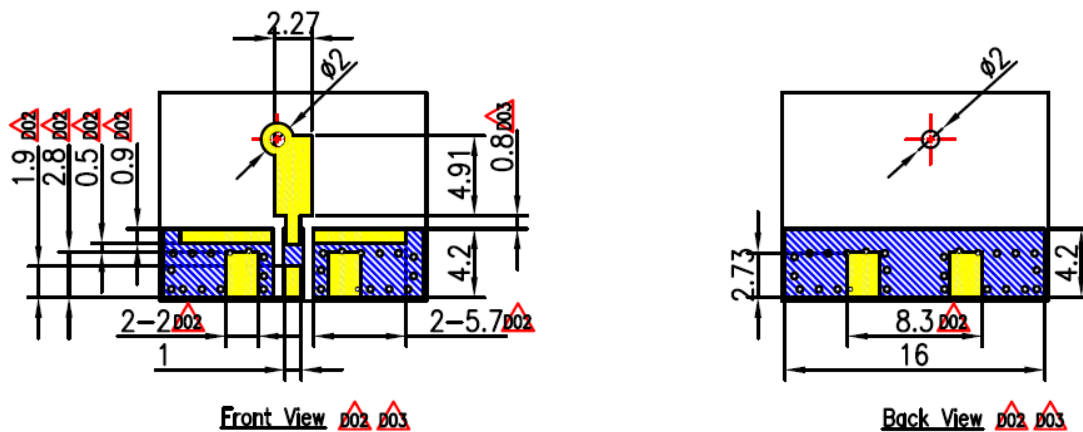

Detailed dimensions EVB front and back

9.2 Ground Plane Size Influence

Influence of ground plane length and width is tested.

Length

Graphs below show that there is only slight influence on S11 and on Efficiency when the ground plane length is increased. However the ground plane length has strong influence on the achieved axial ratio as seen in Figure 7. Those results show that length up to 10 mm maintains the antenna performance. Length of 15 mm is not recommended (square ground plane), lengths above 20 mm can be used but with precaution. Taoglas recommends making a small isolated RF ground for the UWCCP.01, in case large ground plane is needed for the device, connected with inductors to the main PCB ground.

Width

When the ground plane width is increased the antenna becomes detuned as evident on both S11 and efficiency. Axial Ratio, S11, and efficiency show that widths of 30 mm and 40 mm are not advisable.

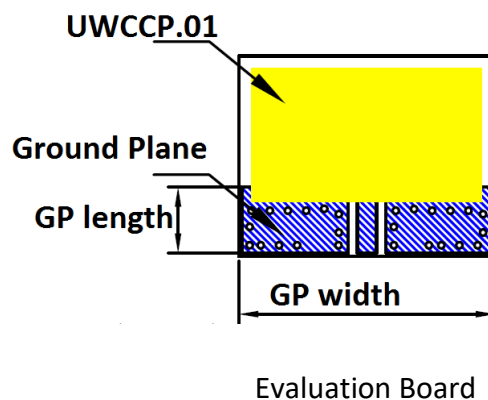

9.3 Ground Plane Length

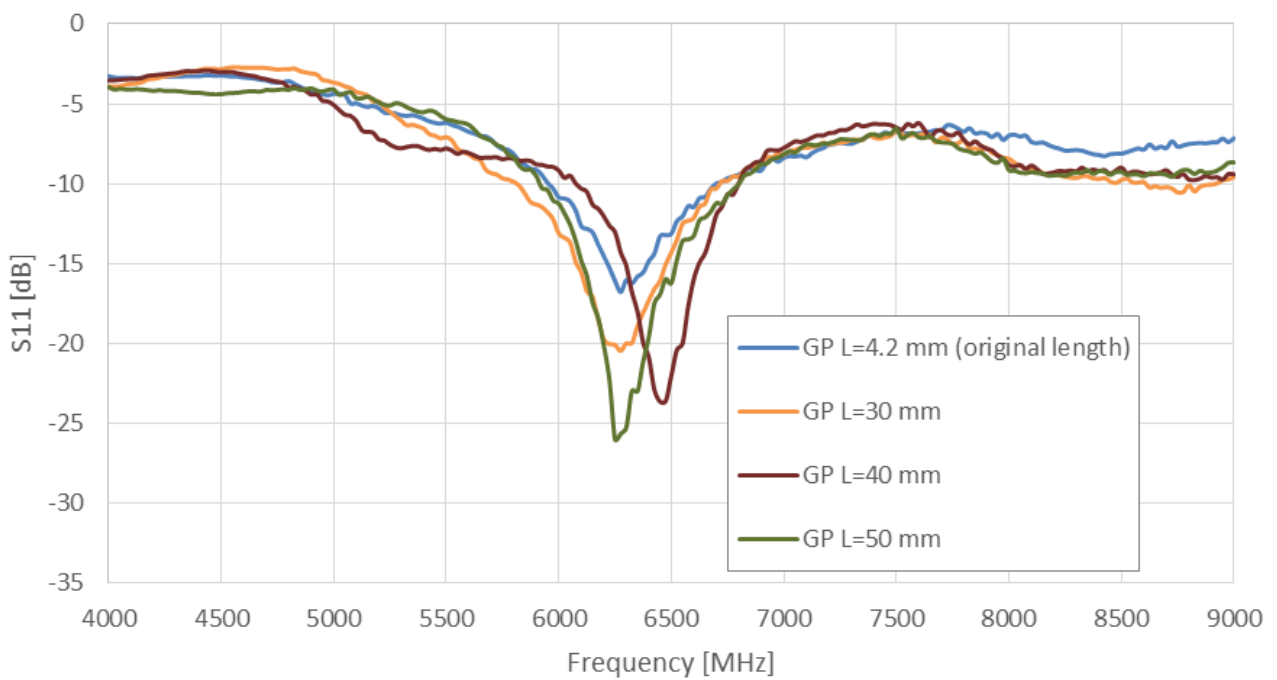
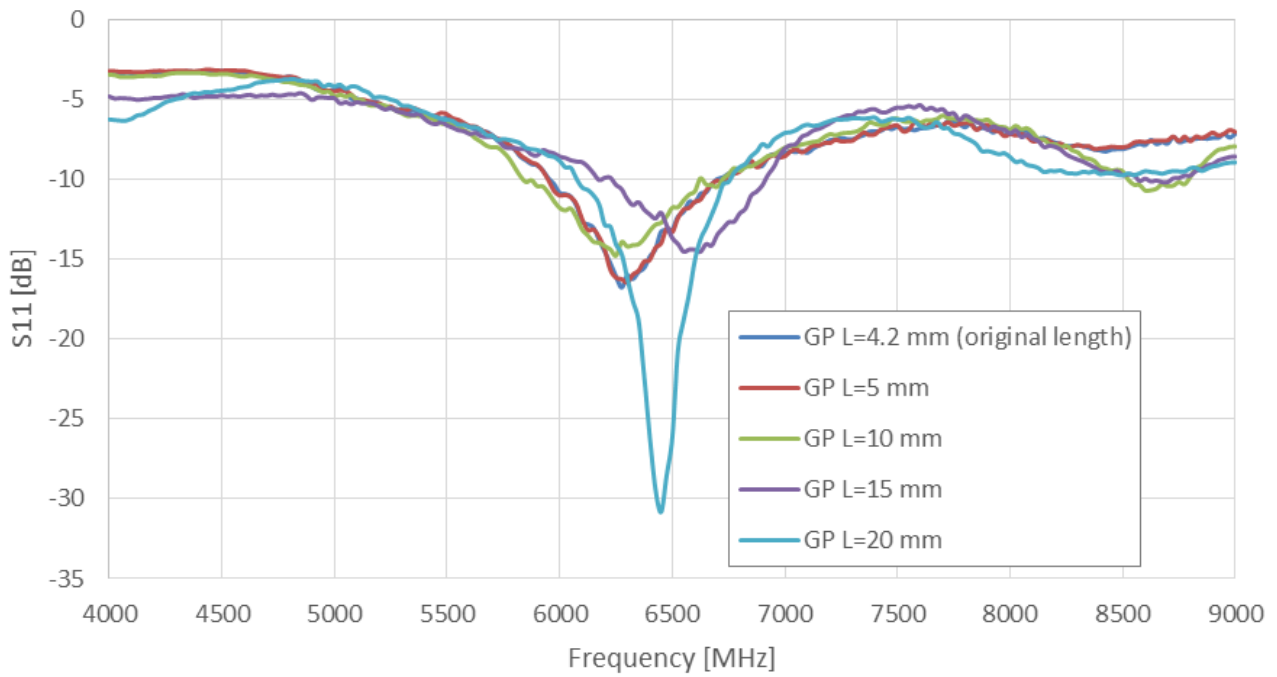

Return loss for ground plane length variations

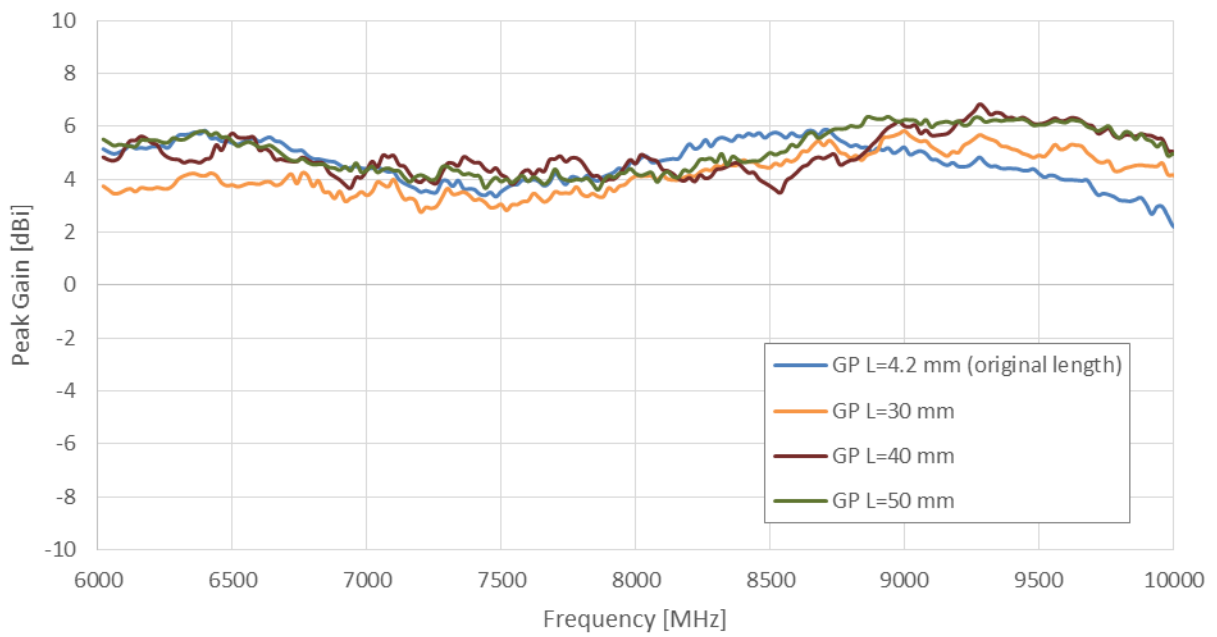
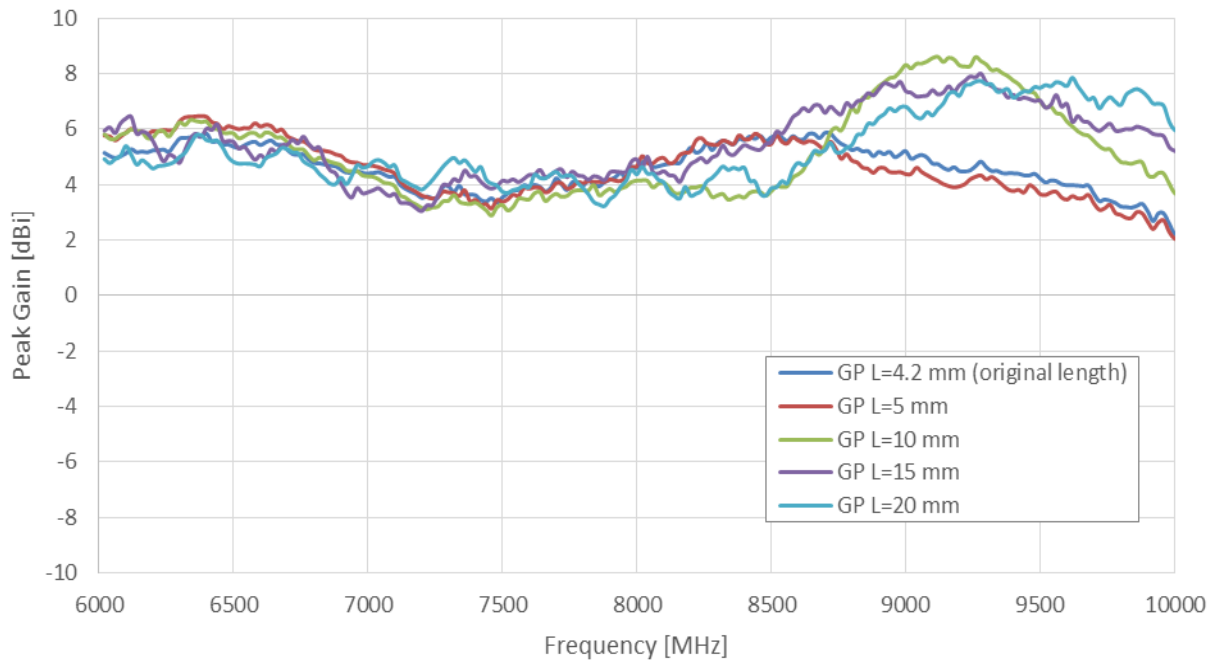

Peak gain for ground plane length variations

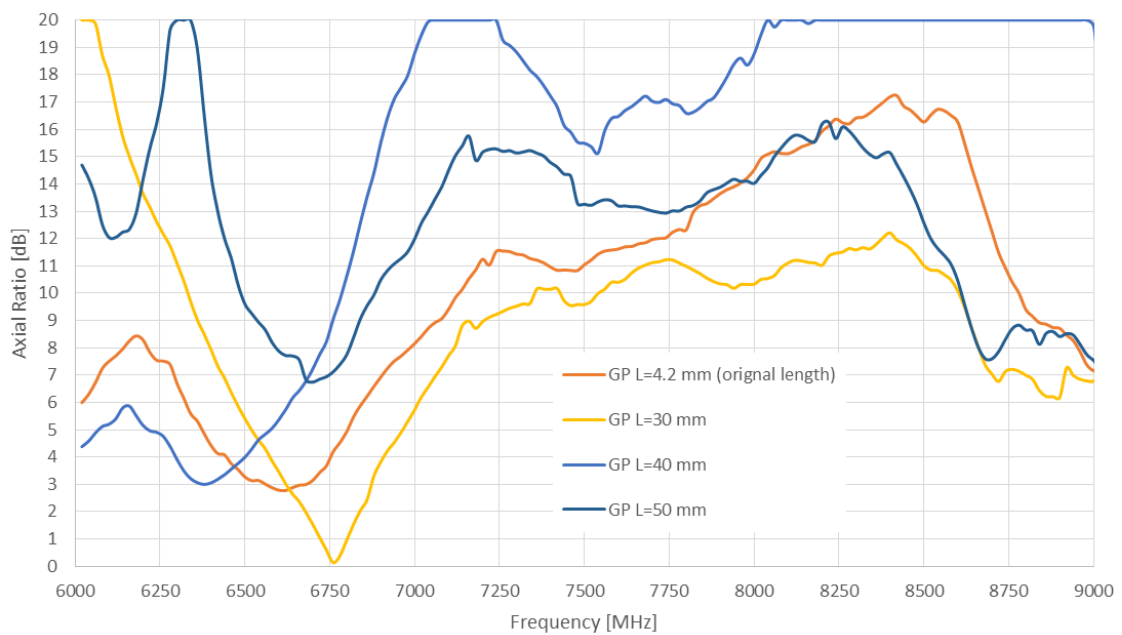
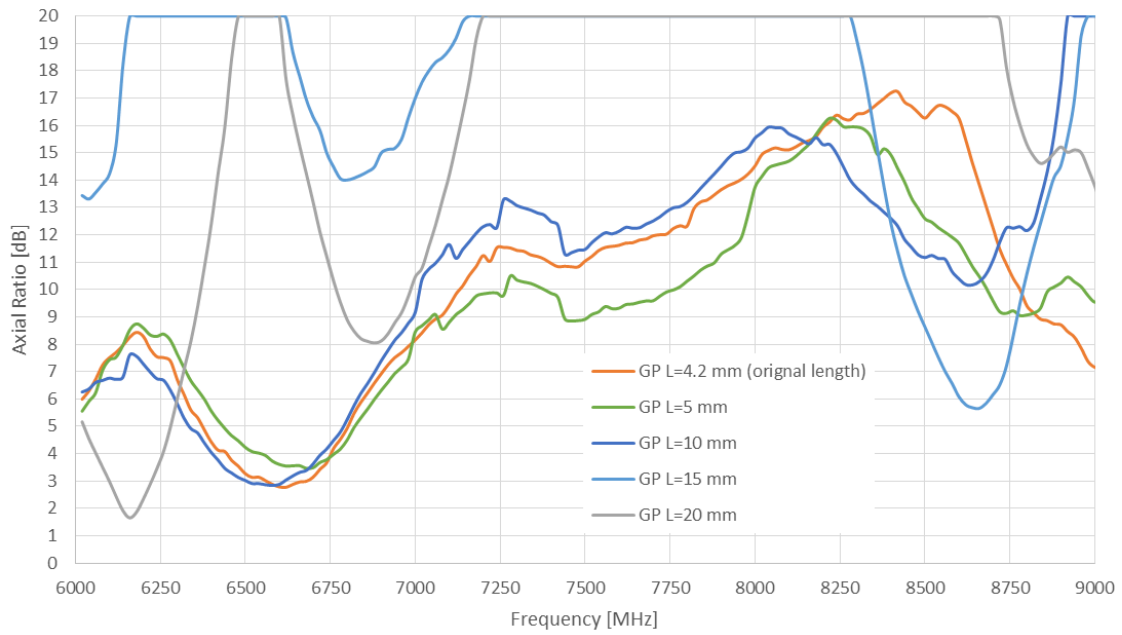

Axial Ratio for ground plane length variation

9.4 Ground Plane Width

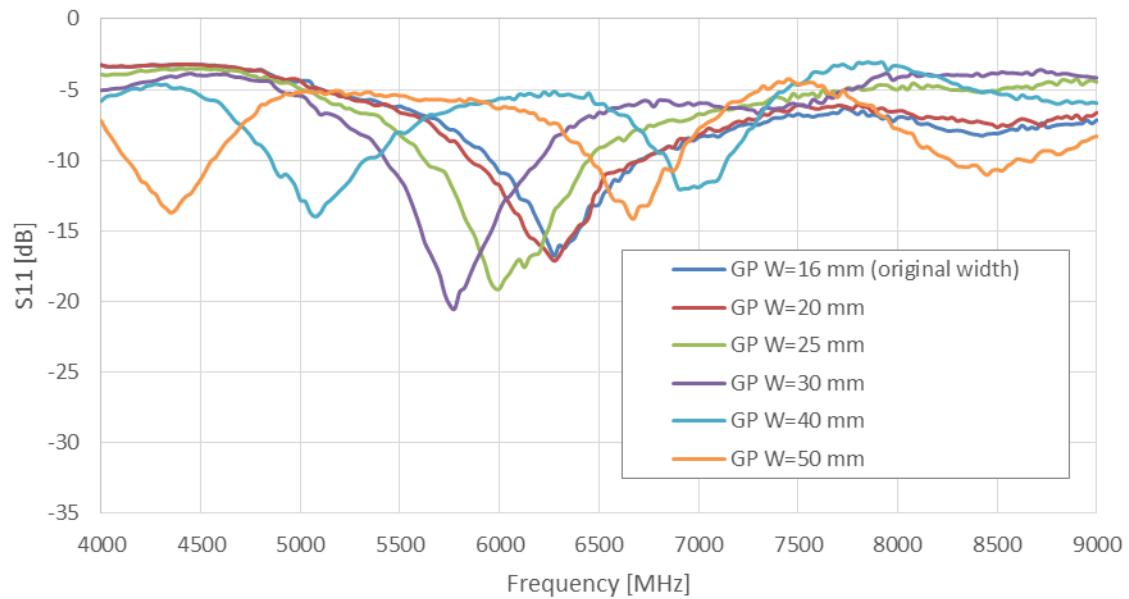

Return loss for ground plane width variation

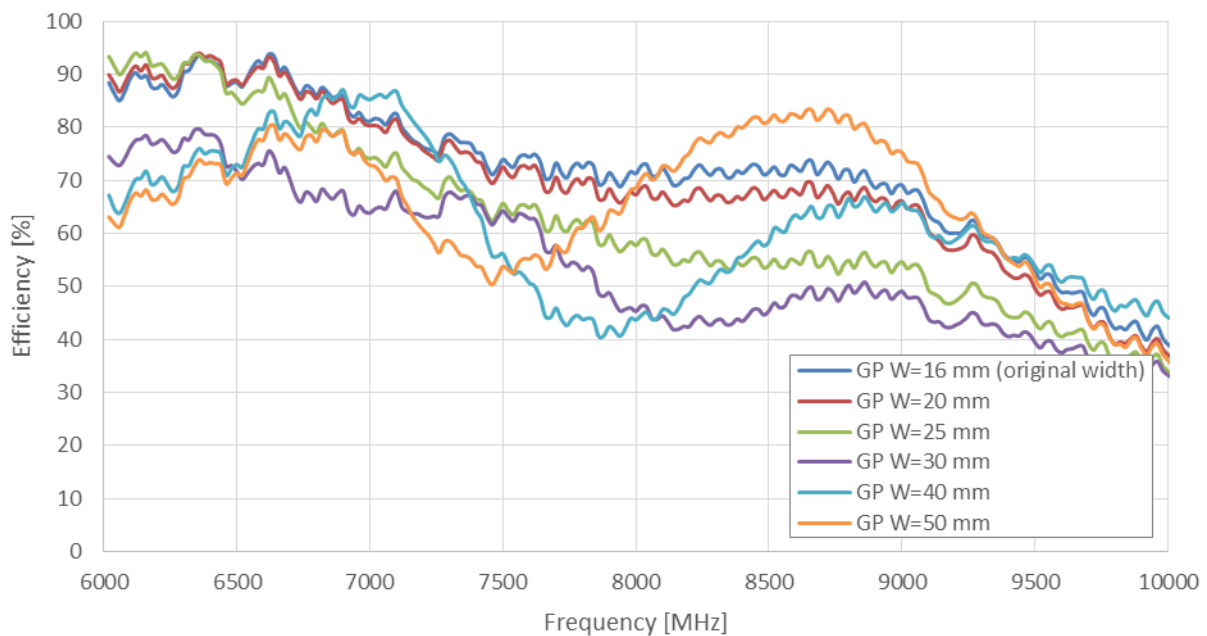

Efficiency for ground plane width variation

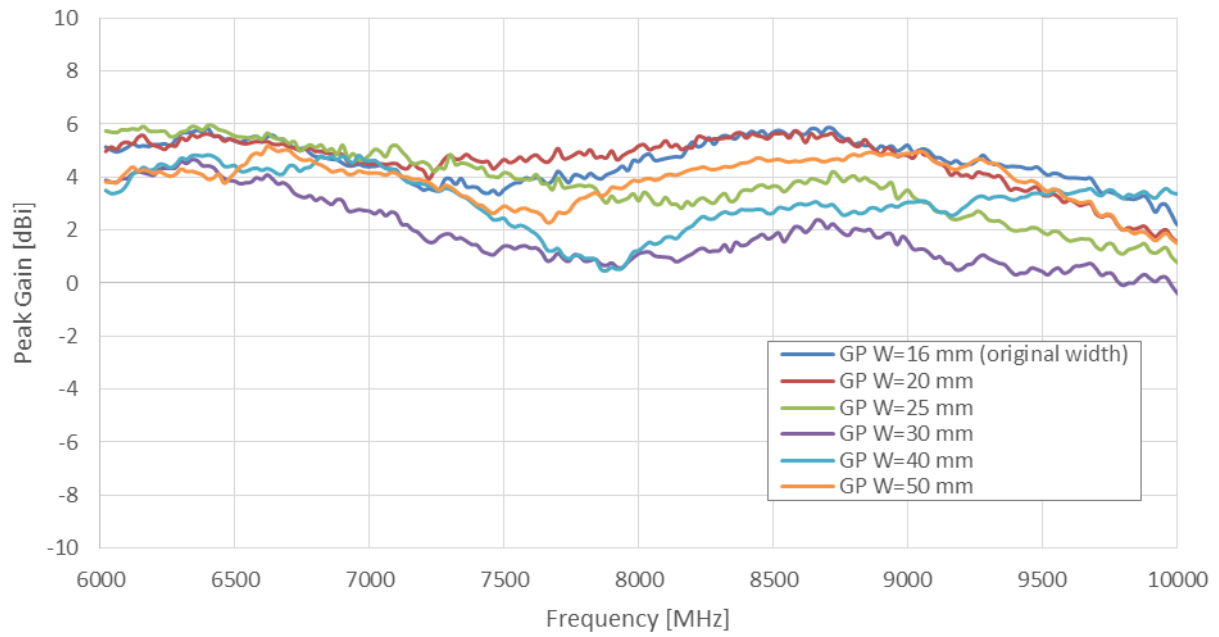

Peak gain for ground plane width variation

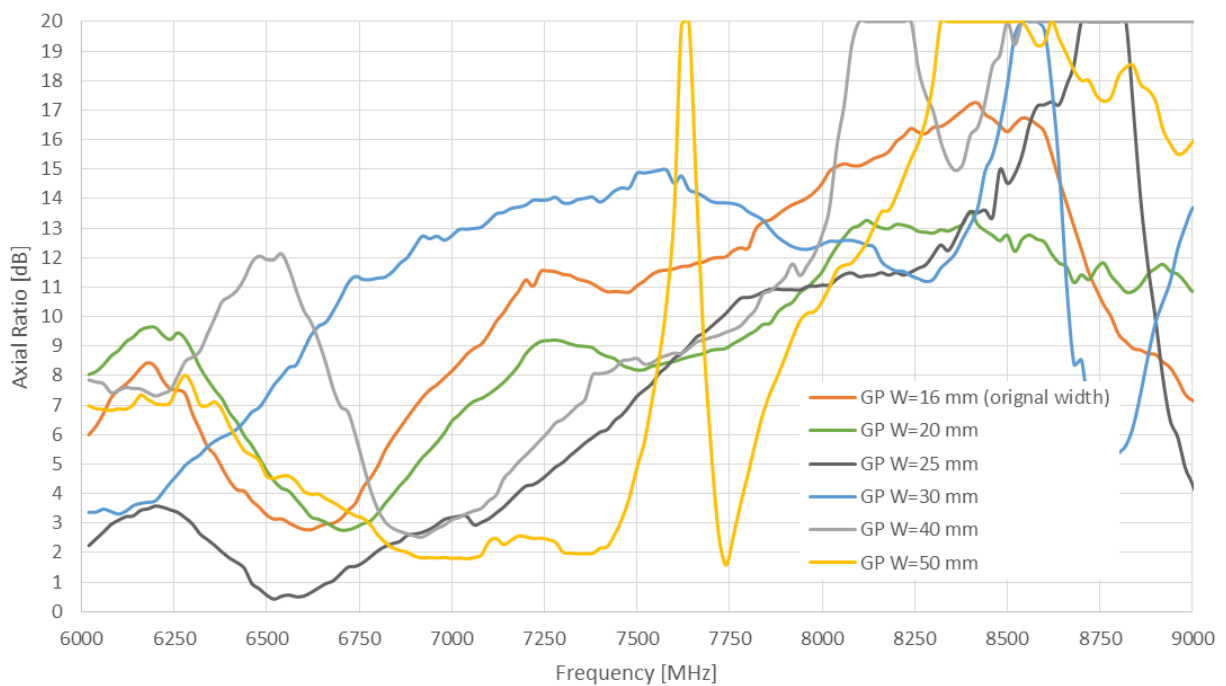

Axial ratio for ground plane width variation

Changelog for the datasheet

SPE-17-8-057- UWCCP.01

Revision: H (Current Version)

Date:	2023-12-15
Changes:	Updated Electrical information
Changes Made by:	Cesar Sousa

Previous Revisions

Revision: G

Date:	2023-09-06
Changes:	Updated Solder Reflow Information
Changes Made by:	Cesar Sousa

Revision: B

Date:	2018-03-22
Changes:	New Mechanical Drawing
Changes Made by:	Andy Mahoney

Revision: F

Date:	2022-05-03
Changes:	Addition of Packaging Section
Changes Made by:	Paul Doyle

Revision: A (Original First Release)

Date:	2017-06-09
Notes:	First Release
Author:	Andela Zaric

Revision: E

Date:	2022-01-17
Changes:	Addition of the solder reflow profile.
Changes Made by:	Gary West

Revision: D

Date:	2021-09-27
Changes:	MSL updated.
Changes Made by:	Erik Landi

Revision: C

Date:	2021-05-20
Changes:	New datasheet Template Update and Addition of Antenna Integration Guide
Changes Made by:	Gary West



TAOGLAS®

www.taoglas.com

