

## OLGA-RS

~6° spot beam beam. Optimized for high-power 3535 size LED packages. Assembly with holder and installation tape.

### SPECIFICATION:

Dimensions	Ø 32.0
Height	19.1 mm
Fastening	tape, pin
ROHS compliant	yes ⓘ



### MATERIALS:

Component	Type	Material	Colour	Finish	Length (mm)
OLGA-HLD2	Holder	PC	black		
OLGA-RS	Single lens	PMMA	clear		
SPUTNIK-TAPE3	Tape	Acryl tape	black		

### ORDERING INFORMATION:

Component	Qty in box	MOQ	MPQ	Box weight (kg)
CA16672_OLGA-RS » Box size: 476 x 273 x 292 mm	792	132	66	9.8

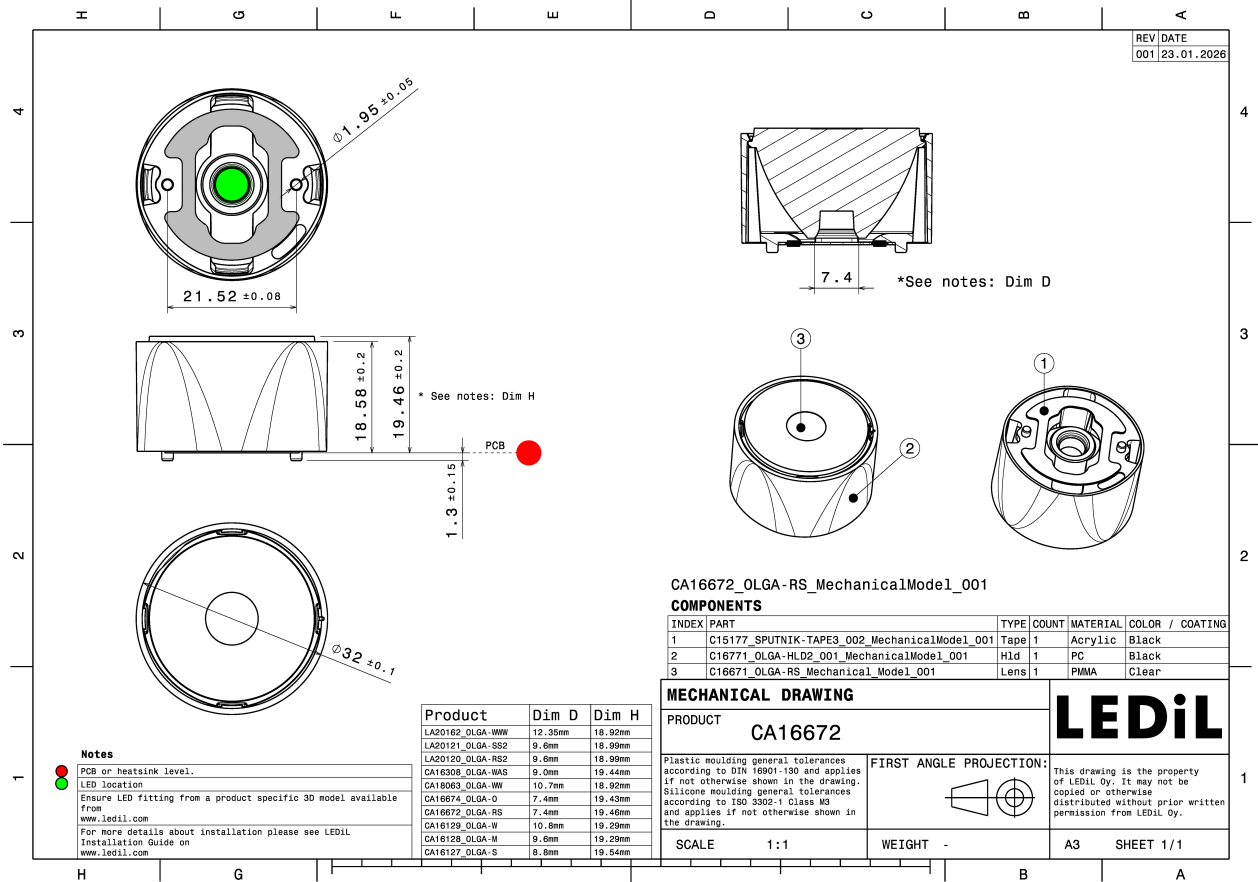

See also our general installation guide: [www.ledil.com/installation\\_guide](http://www.ledil.com/installation_guide)

### OPTICAL RESULTS (MEASURED):



**LED** XHP35 HD  
**FWHM / FWTM** 13.0° / 29.0°  
**Efficiency** 84 %  
**Peak intensity** 9.8 cd/lm  
**LEDs/each optic** 1  
**Light colour/type** White  
**Required components:**

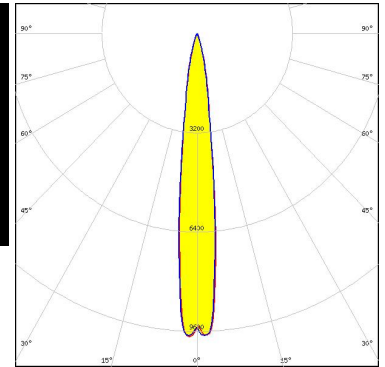

Light distribution files



**LED** XHP35 HI  
**FWHM / FWTM** 9.0° / 22.0°  
**Efficiency** 87 %  
**Peak intensity** 18.8 cd/lm  
**LEDs/each optic** 1  
**Light colour/type** White  
**Required components:**

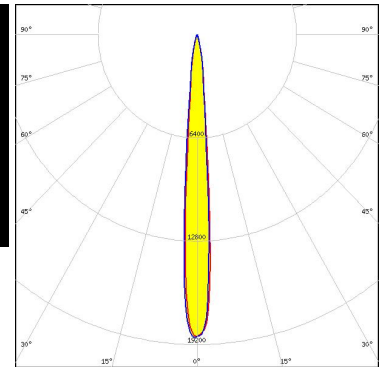
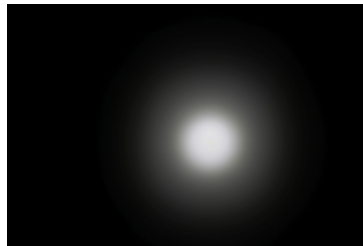

Light distribution files



**LED** XHP50.2  
**FWHM / FWTM** 17.0° / 41.0°  
**Efficiency** 78 %  
**Peak intensity** 5.1 cd/lm  
**LEDs/each optic** 1  
**Light colour/type** White  
**Required components:**

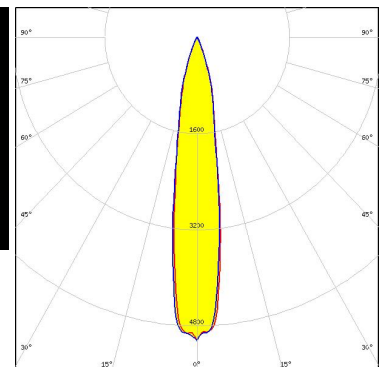

Light distribution files

#### OPTICAL RESULTS (MEASURED):



LED XM-L3  
 FWHM / FWTM 11.0° / 25.0°  
 Efficiency 86 %  
 Peak intensity 13.6 cd/lm  
 LEDs/each optic 1  
 Light colour/type White  
 Required components:

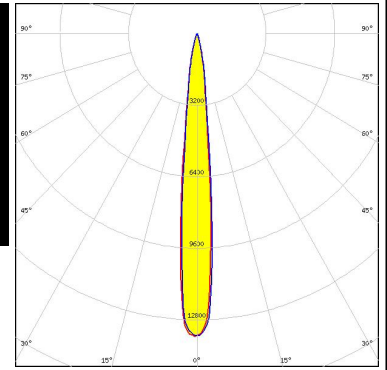
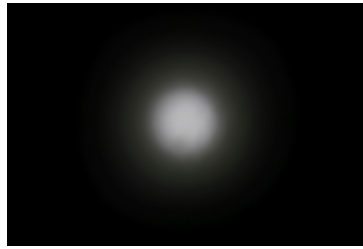

Light distribution files



LED XP-E  
 FWHM / FWTM 5.0° / 12.0°  
 Efficiency 87 %  
 Peak intensity 45.6 cd/lm  
 LEDs/each optic 1  
 Light colour/type White  
 Required components:

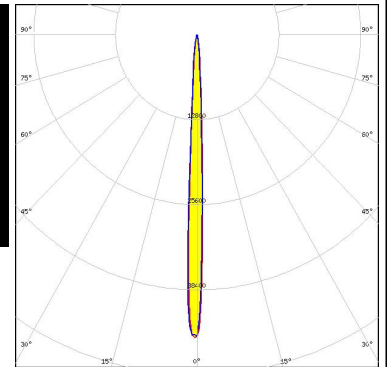
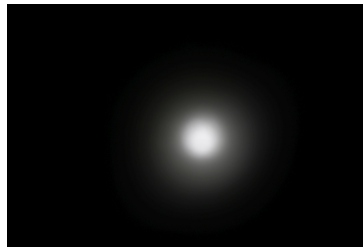

Light distribution files



LED XP-E2  
 FWHM / FWTM 4.9° / 11.6°  
 Efficiency 86 %  
 Peak intensity 50.2 cd/lm  
 LEDs/each optic 1  
 Light colour/type White  
 Required components:

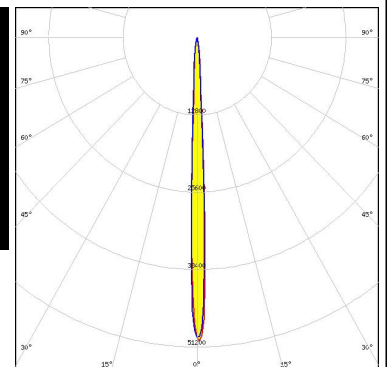

Light distribution files

#### OPTICAL RESULTS (MEASURED):



LED XP-G2  
 FWHM / FWTM 7.0° / 17.0°  
 Efficiency 86 %  
 Peak intensity 28 cd/lm  
 LEDs/each optic 1  
 Light colour/type White  
 Required components:

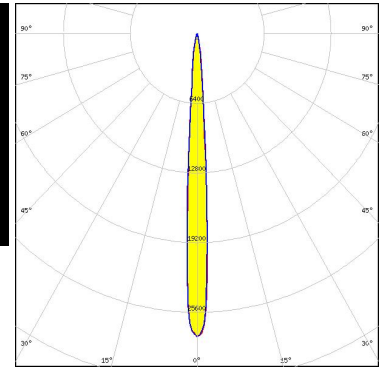
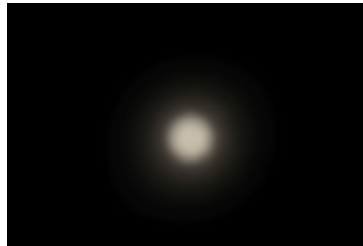

Light distribution files



LED XP-G3  
 FWHM / FWTM 8.0° / 20.0°  
 Efficiency 85 %  
 Peak intensity 21.8 cd/lm  
 LEDs/each optic 1  
 Light colour/type White  
 Required components:

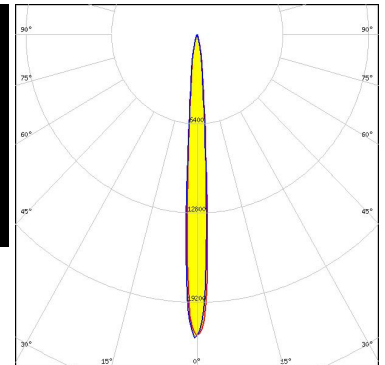
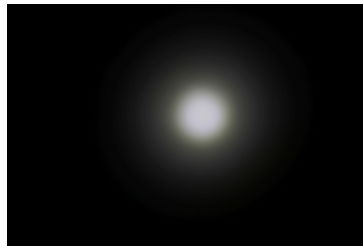

Light distribution files



LED XP-L2  
 FWHM / FWTM 12.0° / 29.0°  
 Efficiency 83 %  
 Peak intensity 10.7 cd/lm  
 LEDs/each optic 1  
 Light colour/type White  
 Required components:

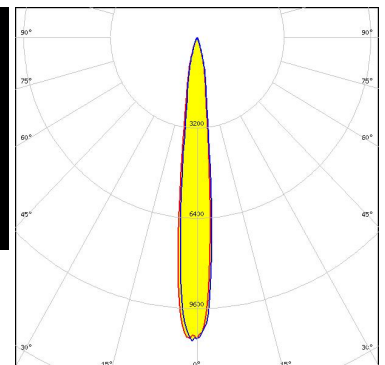

Light distribution files

### OPTICAL RESULTS (MEASURED):



LED XQ-E HD  
 FWHM / FWTM 5.0° / 13.0°  
 Efficiency 79 %  
 Peak intensity 42 cd/lm  
 LEDs/each optic 1  
 Light colour/type White  
 Required components:

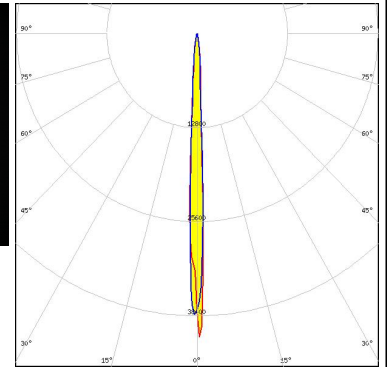

Light distribution files



LED XQ-E HI  
 FWHM / FWTM 3.0° / 9.0°  
 Efficiency 84 %  
 Peak intensity 70 cd/lm  
 LEDs/each optic 1  
 Light colour/type White  
 Required components:

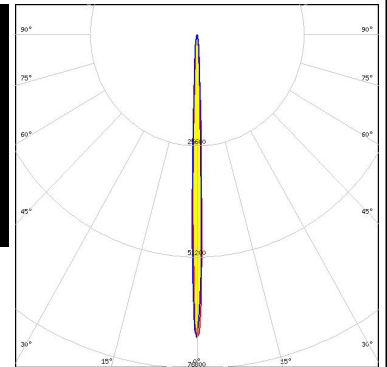
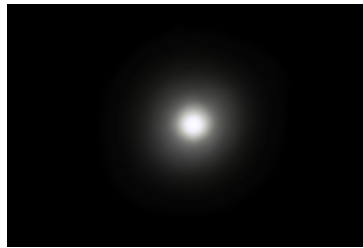

Light distribution files



LED XT-E  
 FWHM / FWTM 8.0° / 19.0°  
 Efficiency 83 %  
 Peak intensity 21.2 cd/lm  
 LEDs/each optic 1  
 Light colour/type White  
 Required components:

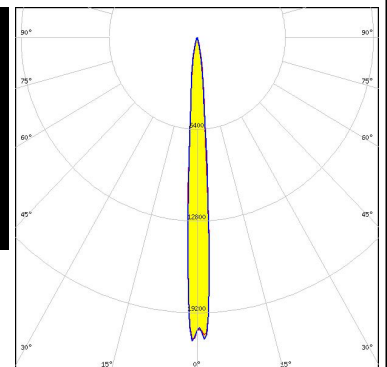
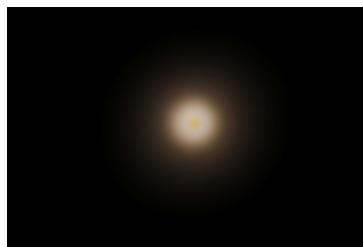

Light distribution files

### OPTICAL RESULTS (MEASURED):



LED LUXEON 5050 Round LES  
 FWHM / FWTM 14.0° / 38.0°  
 Efficiency 86 %  
 Peak intensity 7.1 cd/lm  
 LEDs/each optic 1  
 Light colour/type White  
 Required components:

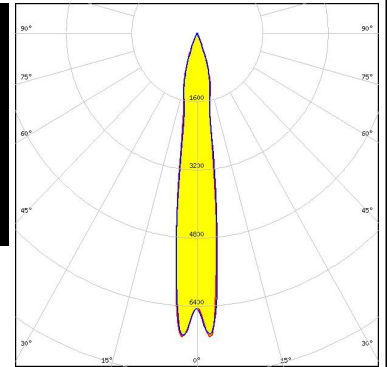
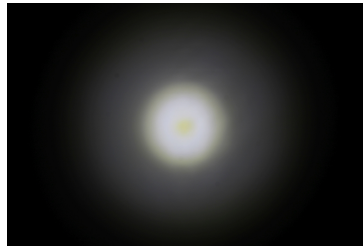

Light distribution files



LED LUXEON MZ  
 FWHM / FWTM 11.0° / 30.0°  
 Efficiency 85 %  
 Peak intensity 11.1 cd/lm  
 LEDs/each optic 1  
 Light colour/type White  
 Required components:

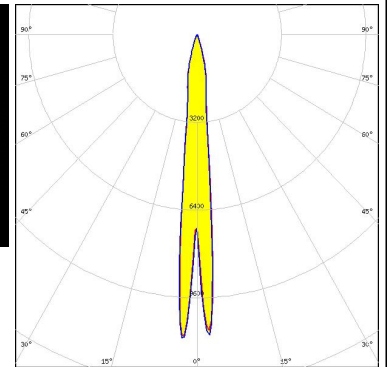

Light distribution files



LED LUXEON TX  
 FWHM / FWTM 7.0° / 18.0°  
 Efficiency 86 %  
 Peak intensity 24.8 cd/lm  
 LEDs/each optic 1  
 Light colour/type White  
 Required components:

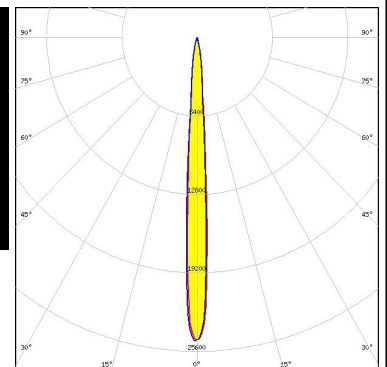
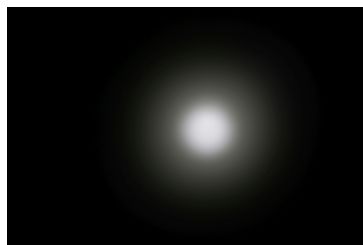

Light distribution files

### OPTICAL RESULTS (MEASURED):



**LED** LUXEON V  
**FWHM / FWTM** 11.0° / 28.0°  
**Efficiency** 84 %  
**Peak intensity** 11.7 cd/lm  
**LEDs/each optic** 1  
**Light colour/type** White  
**Required components:**

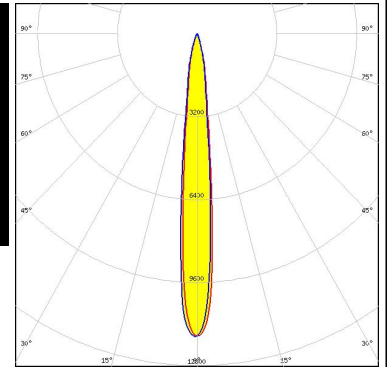
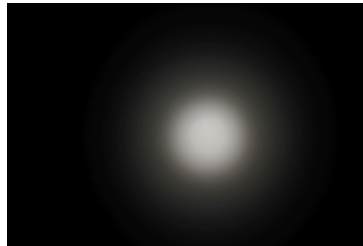

Light distribution files



**LED** LUXEON Z ES  
**FWHM / FWTM** 5.0° / 12.0°  
**Efficiency** 87 %  
**Peak intensity** 44.5 cd/lm  
**LEDs/each optic** 1  
**Light colour/type** White  
**Required components:**

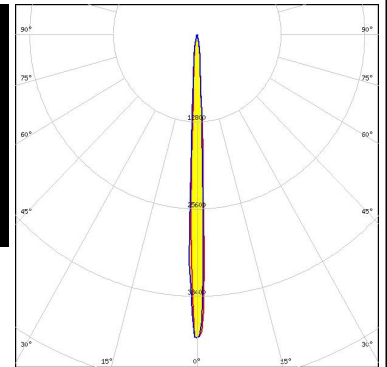
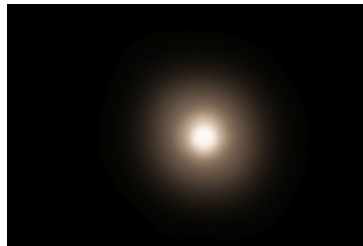

Light distribution files



**LED** NCSxE17A  
**FWHM / FWTM** 4.0° / 13.0°  
**Efficiency** 83 %  
**Peak intensity** 37.1 cd/lm  
**LEDs/each optic** 1  
**Light colour/type** White  
**Required components:**

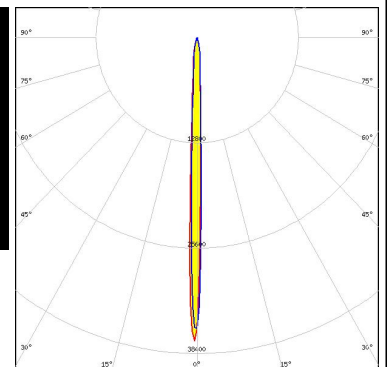

Light distribution files

### OPTICAL RESULTS (MEASURED):



**LED** NV4x144A  
**FWHM / FWTM** 18.0° / 39.0°  
**Efficiency** 83 %  
**Peak intensity** 5.5 cd/lm  
**LEDs/each optic** 1  
**Light colour/type** White  
**Required components:**

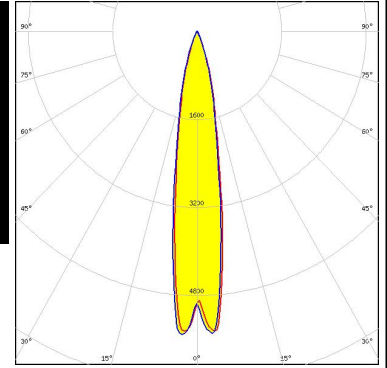
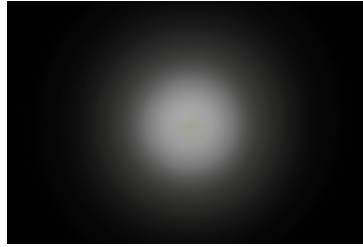

Light distribution files



**LED** NVSW219D  
**FWHM / FWTM** 9.0° / 19.0°  
**Efficiency** 87 %  
**Peak intensity** 21 cd/lm  
**LEDs/each optic** 1  
**Light colour/type** White  
**Required components:**

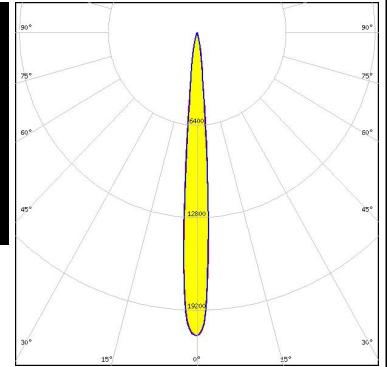
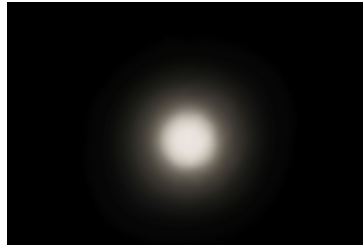

Light distribution files



**LED** NVSW319B  
**FWHM / FWTM** 10.0° / 23.0°  
**Efficiency** 87 %  
**Peak intensity** 16.1 cd/lm  
**LEDs/each optic** 1  
**Light colour/type** White  
**Required components:**

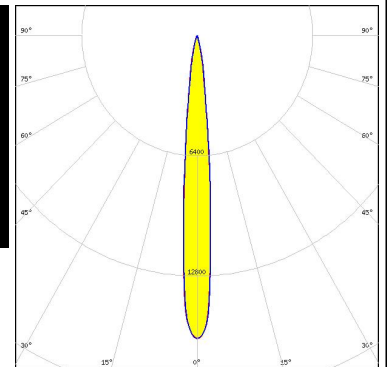
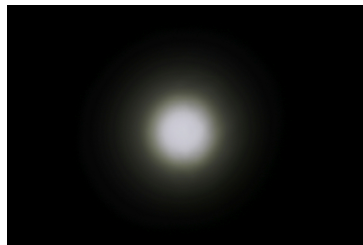

Light distribution files

#### OPTICAL RESULTS (MEASURED):



**LED** NVSW719AC  
**FWHM / FWTM** 8.0° / 19.0°  
**Efficiency** 91 %  
**Peak intensity** 24.6 cd/lm  
**LEDs/each optic** 1  
**Light colour/type** White  
**Required components:**

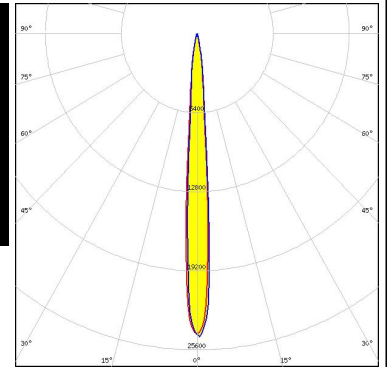

Light distribution files



**LED** NVSxE21A  
**FWHM / FWTM** 5.0° / 16.0°  
**Efficiency** 84 %  
**Peak intensity** 27.4 cd/lm  
**LEDs/each optic** 1  
**Light colour/type** White  
**Required components:**

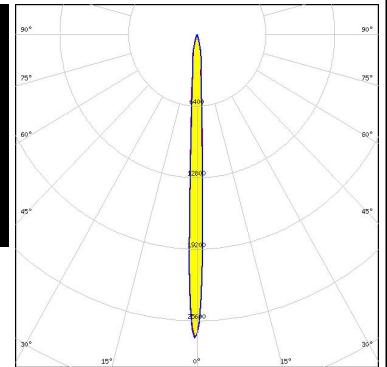

Light distribution files



**LED** NVSxx19B/NVSxx19C  
**FWHM / FWTM** 8.0° / 20.0°  
**Efficiency** 85 %  
**Peak intensity** 20.7 cd/lm  
**LEDs/each optic** 1  
**Light colour/type** White  
**Required components:**

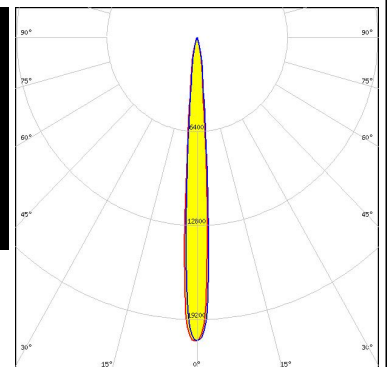
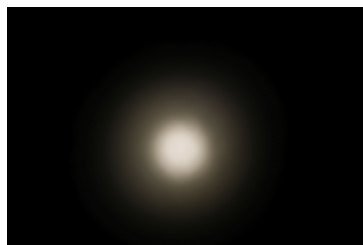

Light distribution files

#### OPTICAL RESULTS (MEASURED):

**OSRAM**  
Opto Semiconductors

LED OSCONIQ P 3737 (2W) PUSRA1  
 FWHM / FWTM 6.0° / 17.0°  
 Efficiency 86 %  
 Peak intensity 26.7 cd/lm  
 LEDs/each optic 1  
 Light colour/type White  
 Required components:

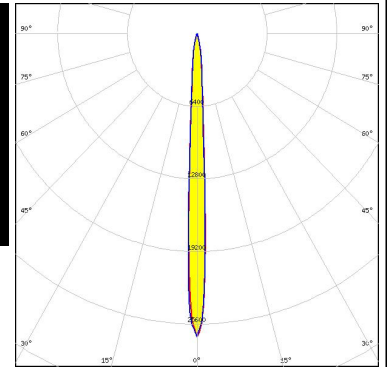
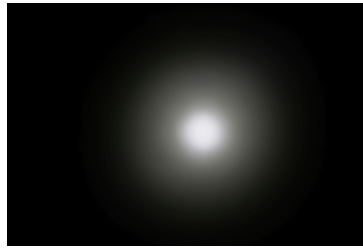

Light distribution files

**OSRAM**  
Opto Semiconductors

LED OSCONIQ P 3737 (3W) PUSTA1  
 FWHM / FWTM 10.0° / 25.0°  
 Efficiency 85 %  
 Peak intensity 14.5 cd/lm  
 LEDs/each optic 1  
 Light colour/type White  
 Required components:

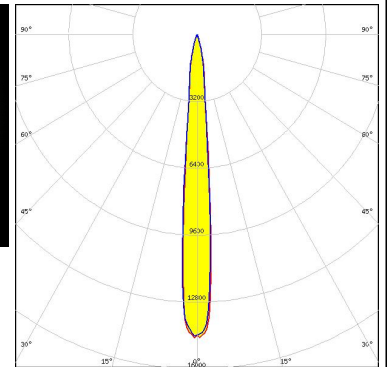
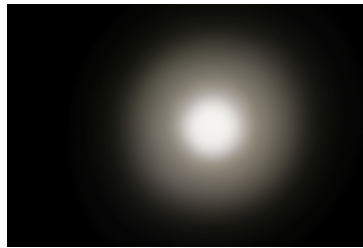

Light distribution files

**OSRAM**  
Opto Semiconductors

LED OSLON Square CSSRM2/CSSRM3  
 FWHM / FWTM 7.0° / 17.0°  
 Efficiency 86 %  
 Peak intensity 26.6 cd/lm  
 LEDs/each optic 1  
 Light colour/type White  
 Required components:

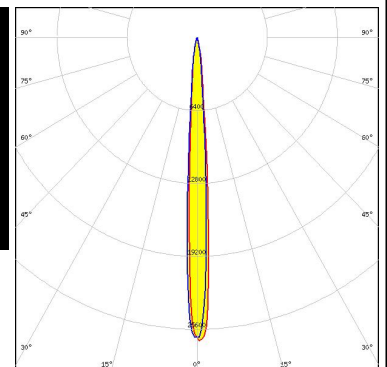

Light distribution files

### OPTICAL RESULTS (MEASURED):

**OSRAM**  
Opto Semiconductors

LED OSLON SSL 150  
FWHM / FWTM 4.0° / 11.0°  
Efficiency 87 %  
Peak intensity 57 cd/lm  
LEDs/each optic 1  
Light colour/type White  
Required components:

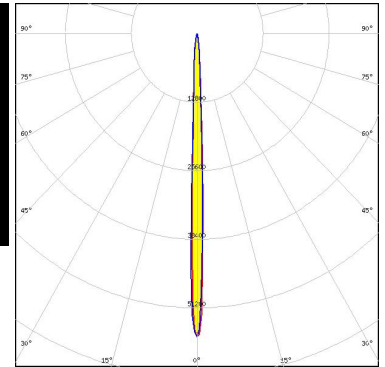
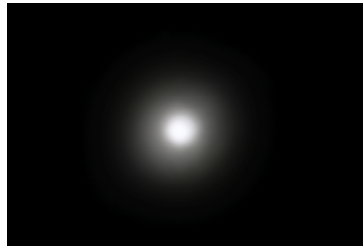

Light distribution files

**SAMSUNG**

LED LH231B  
FWHM / FWTM 7.0° / 24.0°  
Efficiency 86 %  
Peak intensity 18 cd/lm  
LEDs/each optic 1  
Light colour/type White  
Required components:

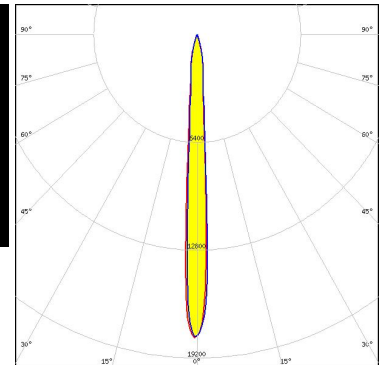

Light distribution files

**SAMSUNG**

LED LH351B  
FWHM / FWTM 8.0° / 19.0°  
Efficiency 86 %  
Peak intensity 21.8 cd/lm  
LEDs/each optic 1  
Light colour/type White  
Required components:

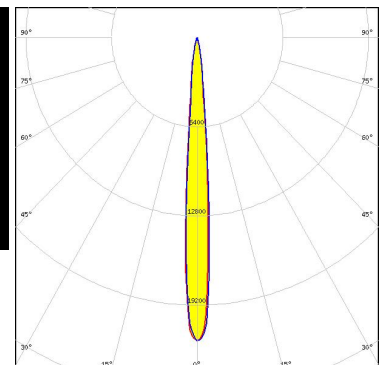
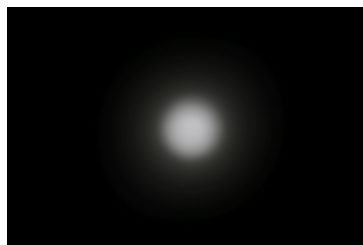

Light distribution files

#### OPTICAL RESULTS (MEASURED):

### SAMSUNG

LED LH351C  
 FWHM / FWTM 9.0° / 21.0°  
 Efficiency 87 %  
 Peak intensity 19.5 cd/lm  
 LEDs/each optic 1  
 Light colour/type White  
 Required components:

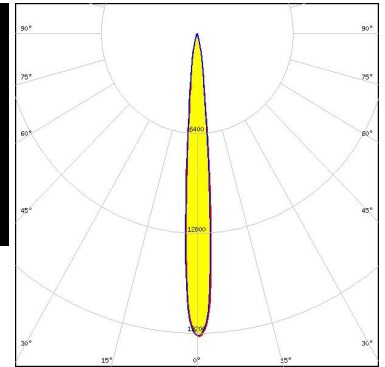
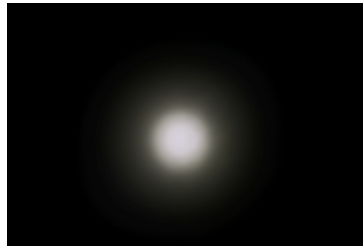

Light distribution files

### SAMSUNG

LED LH351D  
 FWHM / FWTM 12.0° / 26.0°  
 Efficiency 86 %  
 Peak intensity 12.1 cd/lm  
 LEDs/each optic 1  
 Light colour/type White  
 Required components:

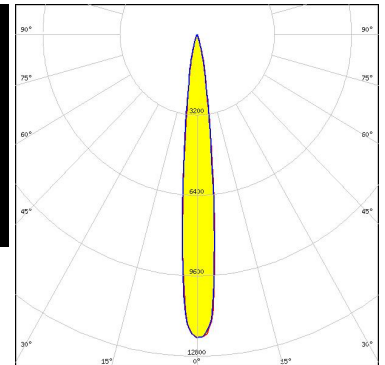
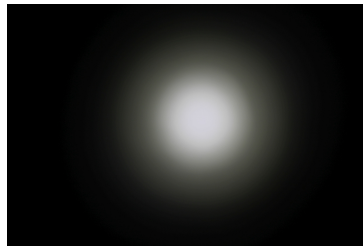

Light distribution files

### SAMSUNG

LED LH508A  
 FWHM / FWTM 14.0° / 38.0°  
 Efficiency 86 %  
 Peak intensity 7.4 cd/lm  
 LEDs/each optic 1  
 Light colour/type White  
 Required components:

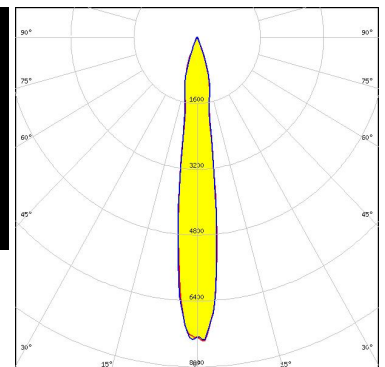

Light distribution files

### OPTICAL RESULTS (MEASURED):

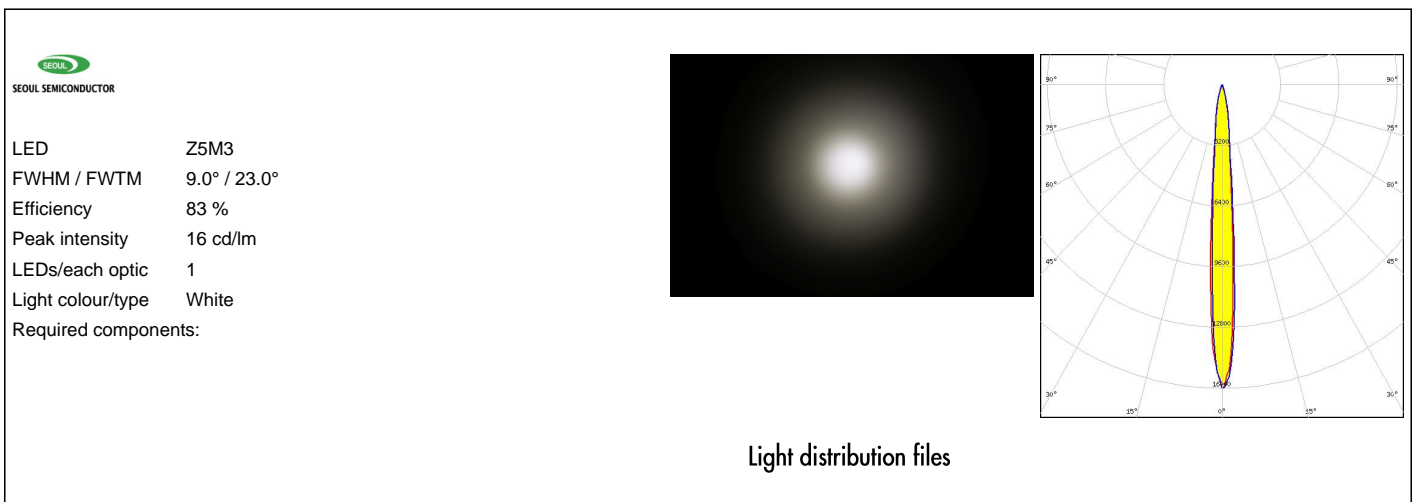
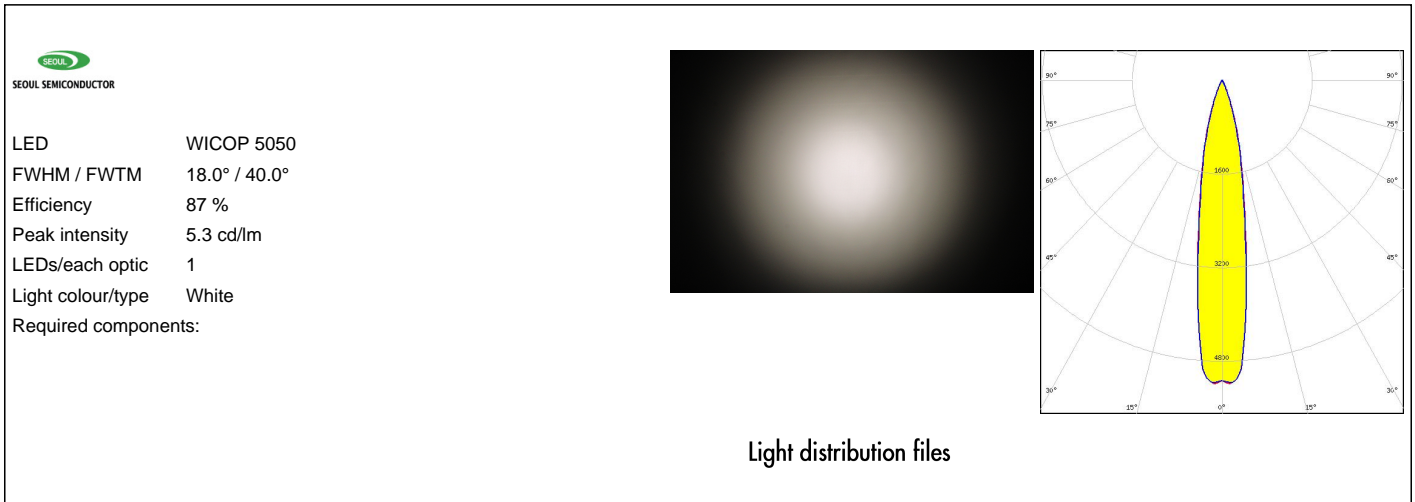

#### OPTICAL RESULTS (SIMULATED):



**LED** SMD 3838 RGBW 3V  
**FWHM / FWTM** 14.0° / 26.0°  
**Efficiency** 94 %  
**Peak intensity** 12.5 cd/lm  
**LEDs/each optic** 1  
**Light colour/type** RGBW  
**Required components:**

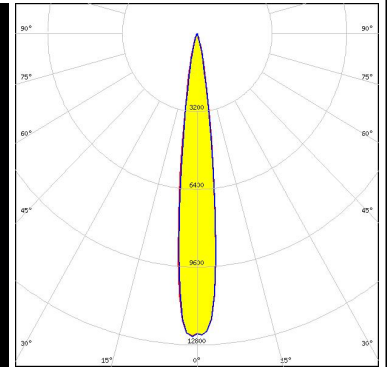

Light distribution files



**LED** J Series 5050 6V P Class  
**FWHM / FWTM** 14.0° / 33.0°  
**Efficiency** 93 %  
**Peak intensity** 10.1 cd/lm  
**LEDs/each optic** 1  
**Light colour/type** White  
**Required components:**

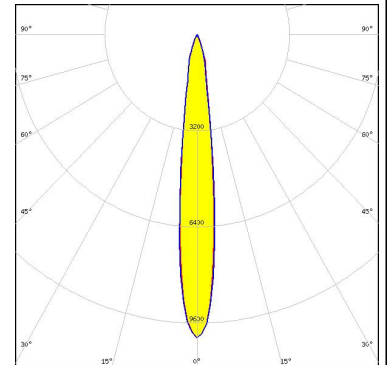

Light distribution files



**LED** XHP35 HI  
**FWHM / FWTM** 9.0° / 18.0°  
**Efficiency** 92 %  
**Peak intensity** 25 cd/lm  
**LEDs/each optic** 1  
**Light colour/type** White  
**Required components:**

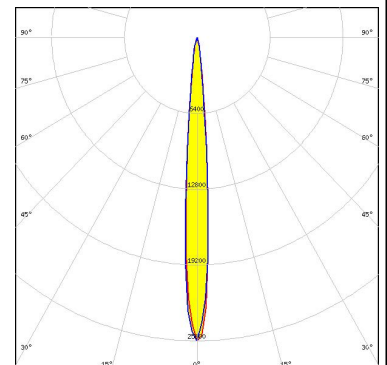

Light distribution files

### OPTICAL RESULTS (SIMULATED):



LED XHP35.2 HD  
 FWHM / FWTM 16.0° / 30.0°  
 Efficiency 89 %  
 Peak intensity 9.2 cd/lm  
 LEDs/each optic 1  
 Light colour/type White  
 Required components:

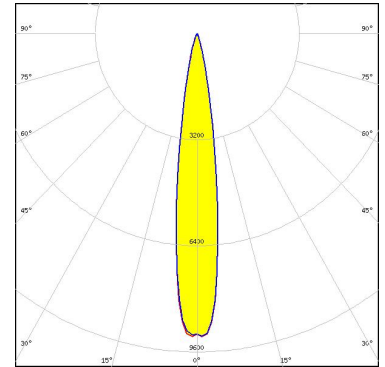

Light distribution files



LED XHP35.2 HI  
 FWHM / FWTM 12.0° / 24.0°  
 Efficiency 93 %  
 Peak intensity 14.7 cd/lm  
 LEDs/each optic 1  
 Light colour/type White  
 Required components:

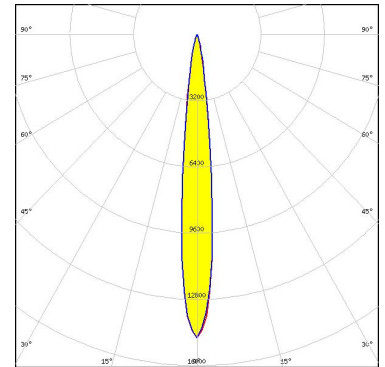

Light distribution files



LED XHP50.2  
 FWHM / FWTM 18.0° / 36.0°  
 Efficiency 88 %  
 Peak intensity 6.9 cd/lm  
 LEDs/each optic 1  
 Light colour/type White  
 Required components:

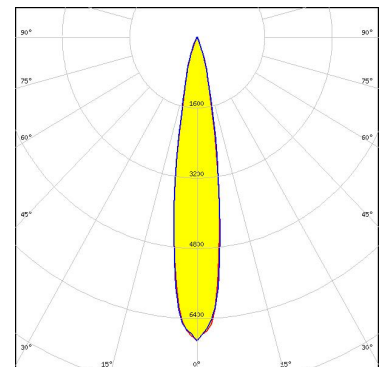

Light distribution files

### OPTICAL RESULTS (SIMULATED):



**LED** XHP50.3 HD  
**FWHM / FWTM** 16.0 + 18.0° / 32.0°  
**Efficiency** 89 %  
**Peak intensity** 7.7 cd/lm  
**LEDs/each optic** 1  
**Light colour/type** White  
**Required components:**

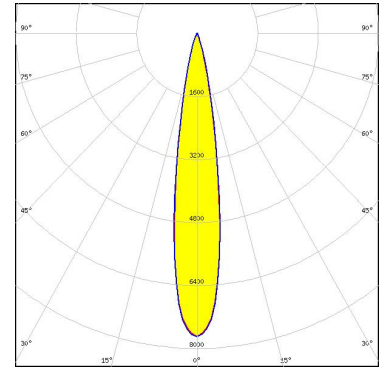

Light distribution files



**LED** XHP70.2  
**FWHM / FWTM** 22.0° / 46.0°  
**Efficiency** 84 %  
**Peak intensity** 3.5 cd/lm  
**LEDs/each optic** 1  
**Light colour/type** White  
**Required components:**

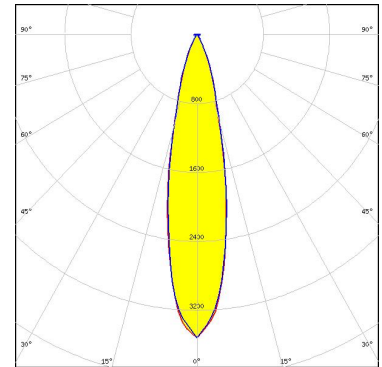

Light distribution files



**LED** XM-L  
**FWHM / FWTM** 12.0° / 23.0°  
**Efficiency** 94 %  
**Peak intensity** 16 cd/lm  
**LEDs/each optic** 1  
**Light colour/type** White  
**Required components:**

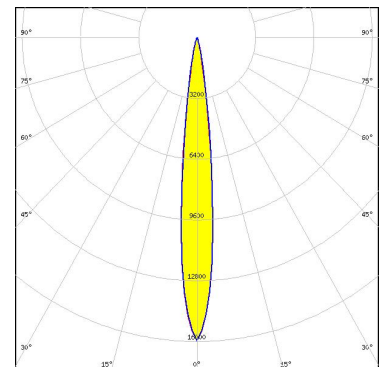

Light distribution files

### OPTICAL RESULTS (SIMULATED):



LED XP-G2 HE  
 FWHM / FWTM 10.0° / 20.0°  
 Efficiency 93 %  
 Peak intensity 20.8 cd/m  
 LEDs/each optic 1  
 Light colour/type White  
 Required components:

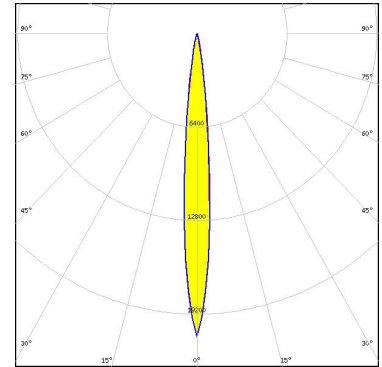

Light distribution files



LED XP-G4  
 FWHM / FWTM 8.0° / 16.0°  
 Efficiency 94 %  
 Peak intensity 31.5 cd/m  
 LEDs/each optic 1  
 Light colour/type White  
 Required components:

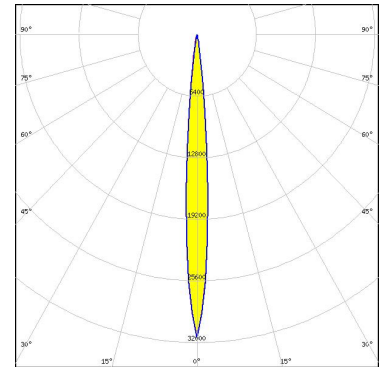

Light distribution files



LED XP-G4 HI  
 FWHM / FWTM 6.0° / 14.0°  
 Efficiency 92 %  
 Peak intensity 37.9 cd/m  
 LEDs/each optic 1  
 Light colour/type White  
 Required components:

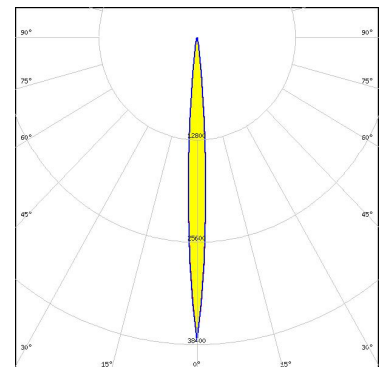

Light distribution files

### OPTICAL RESULTS (SIMULATED):



LED XP-GR  
 FWHM / FWTM 6.0° / 12.0°  
 Efficiency 94 %  
 Peak intensity 66.4 cd/lm  
 LEDs/each optic 1  
 Light colour/type White  
 Required components:

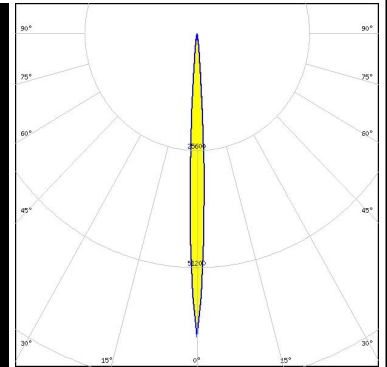
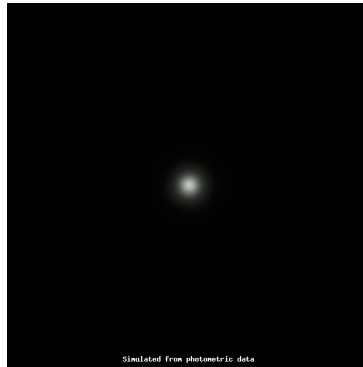

Light distribution files



LED XP-L HI  
 FWHM / FWTM 8.0° / 15.0°  
 Efficiency 92 %  
 Peak intensity 33 cd/lm  
 LEDs/each optic 1  
 Light colour/type White  
 Required components:

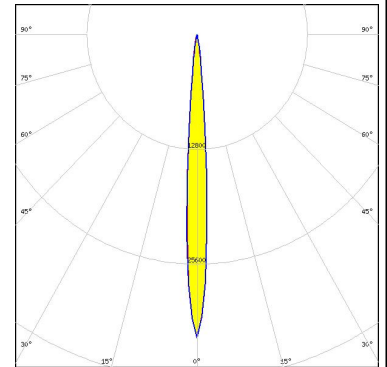

Light distribution files



LED XP-LR  
 FWHM / FWTM 6.0° / 12.0°  
 Efficiency 94 %  
 Peak intensity 52.2 cd/lm  
 LEDs/each optic 1  
 Light colour/type White  
 Required components:

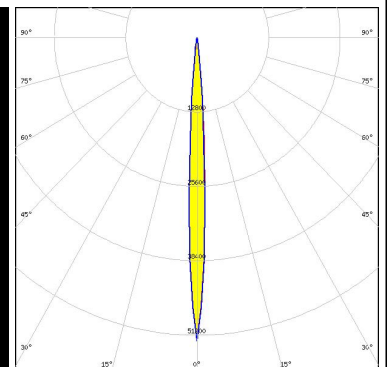
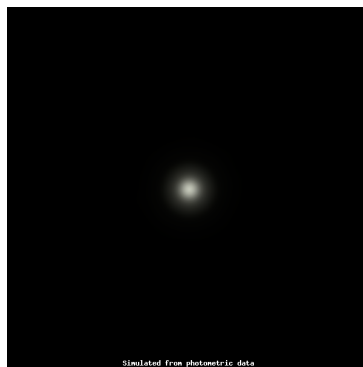

Light distribution files

### OPTICAL RESULTS (SIMULATED):



LED XP-P  
 FWHM / FWTM 6.0° / 12.0°  
 Efficiency 96 %  
 Peak intensity 63.5 cd/lm  
 LEDs/each optic 1  
 Light colour/type White  
 Required components:

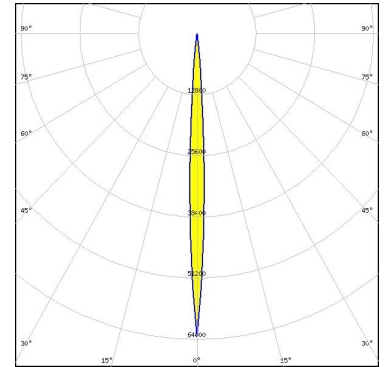

Light distribution files



LED LUXEON 7070  
 FWHM / FWTM 19.0° / 49.0°  
 Efficiency 95 %  
 Peak intensity 4.3 cd/lm  
 LEDs/each optic 1  
 Light colour/type White  
 Required components:

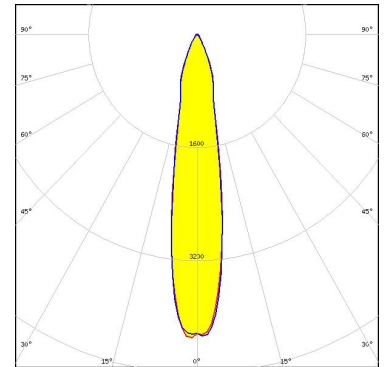

Light distribution files



LED LUXEON C  
 FWHM / FWTM 6.0° / 14.0°  
 Efficiency 89 %  
 Peak intensity 41 cd/lm  
 LEDs/each optic 1  
 Light colour/type White  
 Required components:

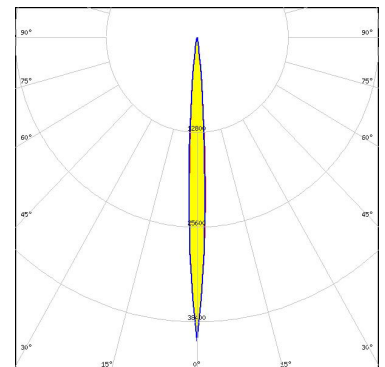

Light distribution files

### OPTICAL RESULTS (SIMULATED):



**LED** LUXEON CZ  
**FWHM / FWTM** 6.0° / 12.0°  
**Efficiency** 93 %  
**Peak intensity** 63.5 cd/lm  
**LEDs/each optic** 1  
**Light colour/type** White  
**Required components:**

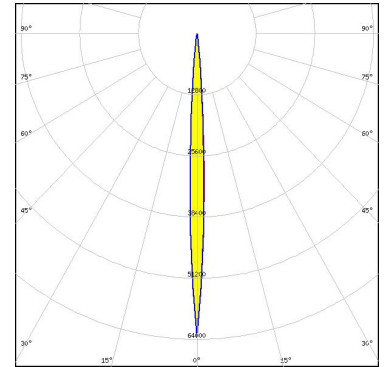

Light distribution files



**LED** LUXEON HL4Z  
**FWHM / FWTM** 8.0° / 18.0°  
**Efficiency** 94 %  
**Peak intensity** 26.7 cd/lm  
**LEDs/each optic** 1  
**Light colour/type** White  
**Required components:**

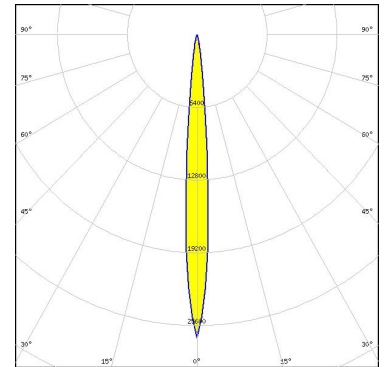

Light distribution files



**LED** SFT-12R-W-A  
**FWHM / FWTM** 4.0° / 10.0°  
**Efficiency** 93 %  
**Peak intensity** 91.2 cd/lm  
**LEDs/each optic** 1  
**Light colour/type** White  
**Required components:**

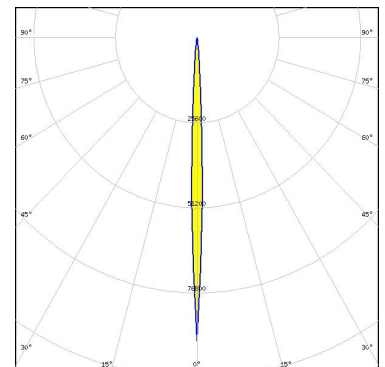

Light distribution files

#### OPTICAL RESULTS (SIMULATED):



LED SST-12 Gen2  
 FWHM / FWTM 6.0° / 14.0°  
 Efficiency 86 %  
 Peak intensity 45.4 cd/lm  
 LEDs/each optic 1  
 Light colour/type White  
 Required components:

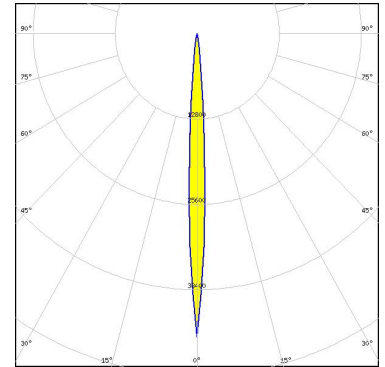

Light distribution files



LED SST-20 Gen2  
 FWHM / FWTM 8.0° / 16.0°  
 Efficiency 93 %  
 Peak intensity 34.7 cd/lm  
 LEDs/each optic 1  
 Light colour/type White  
 Required components:

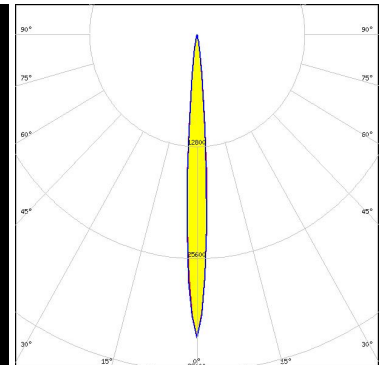
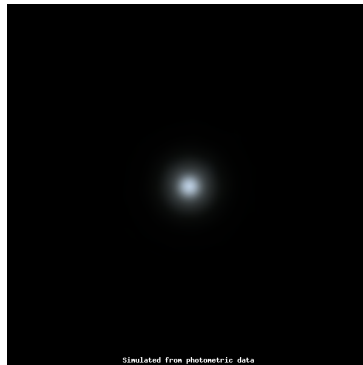

Light distribution files



LED SST-20 Gen2  
 FWHM / FWTM 8.0° / 14.0°  
 Efficiency 93 %  
 Peak intensity 38.3 cd/lm  
 LEDs/each optic 1  
 Light colour/type White  
 Required components:

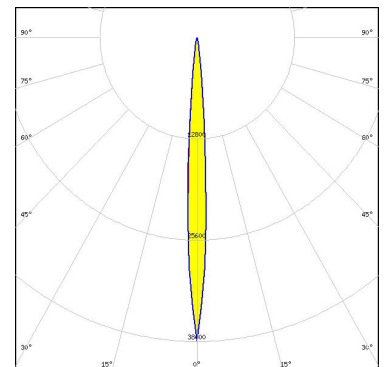

Light distribution files

### OPTICAL RESULTS (SIMULATED):



LED SST-40  
 FWHM / FWTM 12.0° / 24.0°  
 Efficiency 93 %  
 Peak intensity 14.9 cd/lm  
 LEDs/each optic 1  
 Light colour/type White  
 Required components:

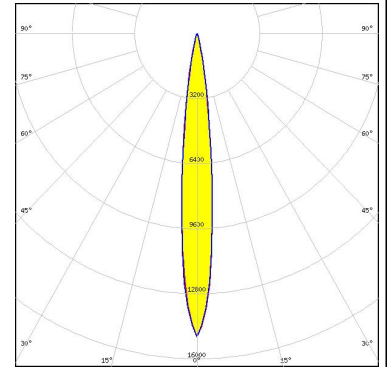

Light distribution files



LED SST-70X-WCS  
 FWHM / FWTM 14.0° / 28.0°  
 Efficiency 94 %  
 Peak intensity 10.9 cd/lm  
 LEDs/each optic 1  
 Light colour/type White  
 Required components:

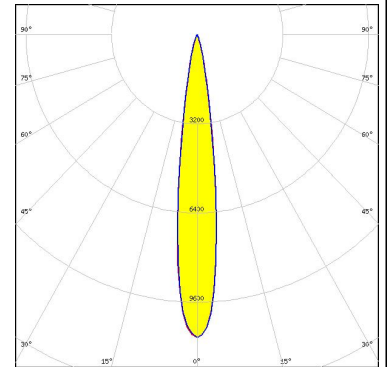

Light distribution files



LED NF2x757G  
 FWHM / FWTM 8.0° / 19.0°  
 Efficiency 94 %  
 Peak intensity 25 cd/lm  
 LEDs/each optic 1  
 Light colour/type White  
 Required components:

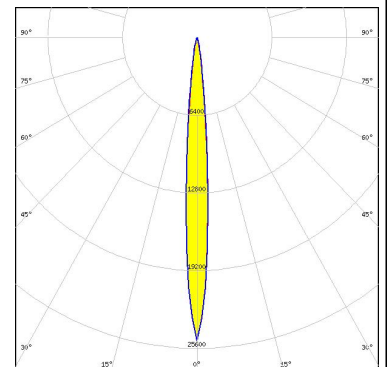

Light distribution files

### OPTICAL RESULTS (SIMULATED):



LED NV4WB35AM  
FWHM / FWTM 12.0° / 26.0°  
Efficiency 93 %  
Peak intensity 13.3 cd/lm  
LEDs/each optic 1  
Light colour/type White  
Required components:

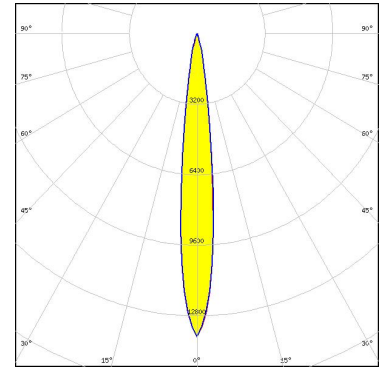

Light distribution files



LED NV4WB35AM  
FWHM / FWTM 12.0° / 26.0°  
Efficiency 94 %  
Peak intensity 13.8 cd/lm  
LEDs/each optic 1  
Light colour/type White  
Required components:

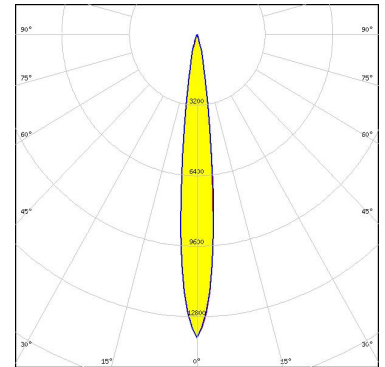

Light distribution files



LED NVSW219C-V2  
FWHM / FWTM 6.0° / 14.0°  
Efficiency 93 %  
Peak intensity 42.5 cd/lm  
LEDs/each optic 1  
Light colour/type White  
Required components:

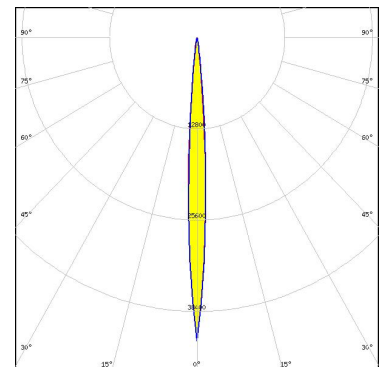

Light distribution files

### OPTICAL RESULTS (SIMULATED):

**OSRAM**  
Opto Semiconductors

LED OSLON PURE 1010  
 FWHM / FWTM 14.0° / 36.0°  
 Efficiency 88 %  
 Peak intensity 8.1 cd/lm  
 LEDs/each optic 9  
 Light colour/type White  
 Required components:

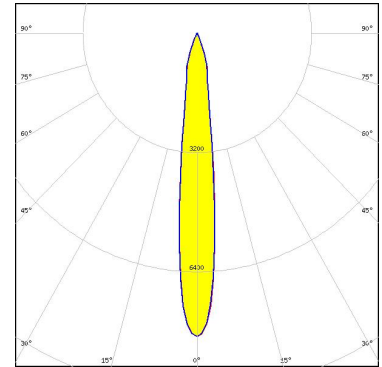

Light distribution files

**OSRAM**  
Opto Semiconductors

LED OSLON Pure 1414  
 FWHM / FWTM 6.0° / 12.0°  
 Efficiency 93 %  
 Peak intensity 59.1 cd/lm  
 LEDs/each optic 1  
 Light colour/type White  
 Required components:

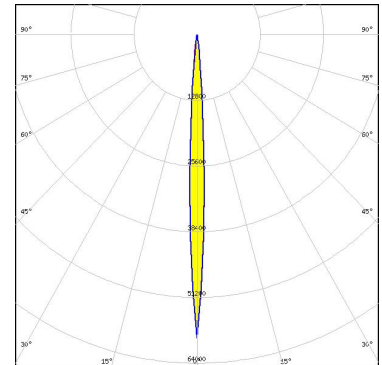

Light distribution files

**OSRAM**  
Opto Semiconductors

LED OSLON Pure 1414  
 FWHM / FWTM 14.0° / 26.0°  
 Efficiency 94 %  
 Peak intensity 11 cd/lm  
 LEDs/each optic 4  
 Light colour/type RGBW  
 Required components:

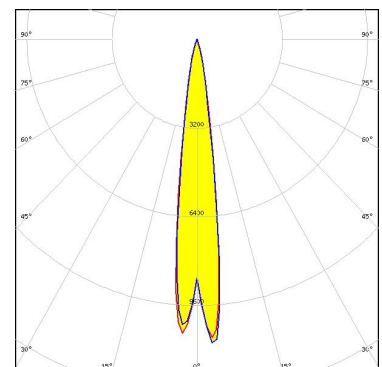

Light distribution files

### OPTICAL RESULTS (SIMULATED):

**OSRAM**  
Opto Semiconductors

LED SFH 4170S  
FWHM / FWTM 6.0° / 12.0°  
Efficiency 82 %  
LEDs/each optic 1  
Light colour/type IR  
Required components:

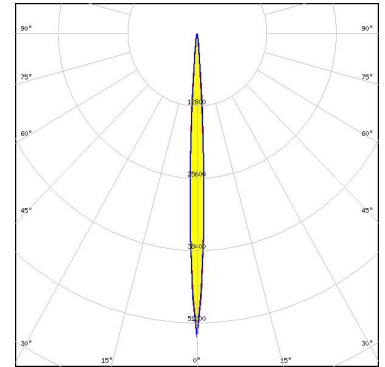

Light distribution files

**OSRAM**  
Opto Semiconductors

LED SFH 4715AS  
FWHM / FWTM 7.0° / 16.0°  
Efficiency 92 %  
LEDs/each optic 1  
Light colour/type IR  
Required components:

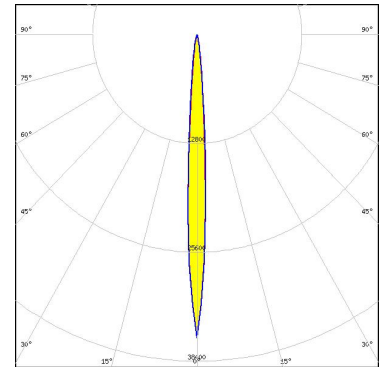

Light distribution files

**OSRAM**  
Opto Semiconductors

LED SFH 4716AS  
FWHM / FWTM 6.0° / 14.0°  
Efficiency 93 %  
LEDs/each optic 1  
Light colour/type IR  
Required components:

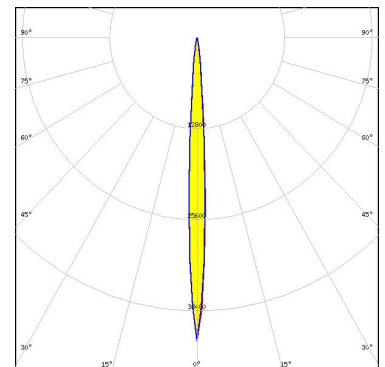

Light distribution files

### OPTICAL RESULTS (SIMULATED):

 SEOUL SEMICONDUCTOR	
LED	Z5M3-E1
FWHM / FWTM	10.0° / 18.0°
Efficiency	94 %
Peak intensity	26.7 cd/m
LEDs/each optic	1
Light colour/type	White
Required components:	

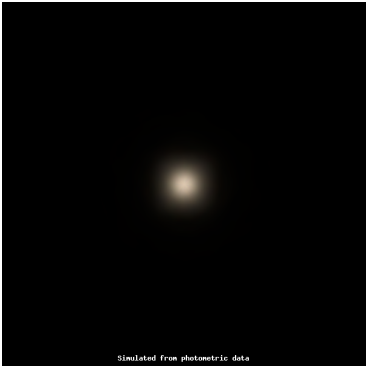

Simulated from photometric data

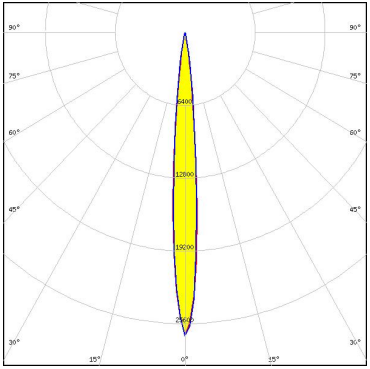

Light distribution files

### GENERAL INFORMATION:

NOTE: The typical beam angle will be changed by different color, chip size and chip position tolerance. The typical total beam angle is the full angle measured where the luminous intensity is half of the peak value.

### MATERIALS:

As part of our continuous research and improvement processes, and to ensure the best possible quality and availability of our products, LEDiL reserves the right to change material grades without notice.

### PRODUCT DATA USER AGREEMENT AND DISCLAIMER:

The measured data in the provided downloadable LEDiL Product Datasheets and Mechanical 2D-Drawings is rounded and provided as reference for planning. LEDiL Oy's optical specifications have been verified by conducting performance testing of the products in accordance with the company's quality system. The reported data are averaged results of multiple measurements with typical variation. LEDiL Oy reserves the right to without prior notification make changes and improvements to its products.

LEDiL Oy assumes neither warranty, nor guarantee nor any other liability of any kind for the contents and correctness of the provided data. The provided data has been generated with highest diligence but the provided data may in reality not represent the complete possible variation range of all intrinsic parameters. Therefore, in certain cases a deviation from the provided data could occur.

LEDiL Oy reserves the right to undertake technical changes of its products without further notification which could lead to changes in the provided data. LEDiL Oy assumes no liability of any kind for the possible deviation from any provided data or any other damage resulting from the usage of the provided data.

The user agrees to this disclaimer and user agreement with the download or usage of the provided files.

#### LEDiL Oy

Joensuunkatu 7  
FI-24100 SALO  
Finland

#### LEDiL Inc.

228 West Page Street  
Suite D  
Sycamore IL 60178  
USA

#### Ledil Optics Technology (Shenzhen) Co., Ltd.

# 405 , Block B  
Casic Motor Building  
Shenzhen 518057  
P.R.CHINA

#### Local sales and technical support

[www.ledil.com/  
where\\_to\\_buy](http://www.ledil.com/where_to_buy)

#### Shipping locations

Poznan, Poland  
Hong Kong, China

#### Distribution Partners

[www.ledil.com/  
where\\_to\\_buy](http://www.ledil.com/where_to_buy)