

GABRIELLA-MIDI-O

~12+40° oval beam with holder and installation tape

SPECIFICATION:

Dimensions	Ø 37.8
Height	24.1 mm
Fastening	tape, pin
ROHS compliant	yes ⓘ

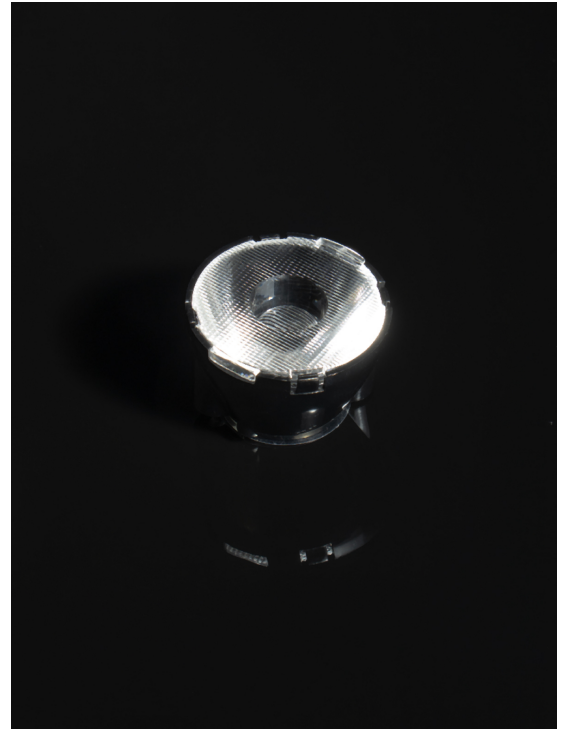

MATERIALS:

Component	Type	Material	Colour	Finish	Length (mm)
GABRIELLA-MIDI-O	Single lens	PMMA	clear		
GABRIELLA-MIDI-HLD	Holder	PC	black		
GABRIELLA-MIDI-HLD	Tape	Acryl tape	black		

ORDERING INFORMATION:

Component	Qty in box	MOQ	MPQ	Box weight (kg)
CA16205_GABRIELLA-MIDI-O » Box size: 476 x 273 x 292 mm	500	100	50	10.9

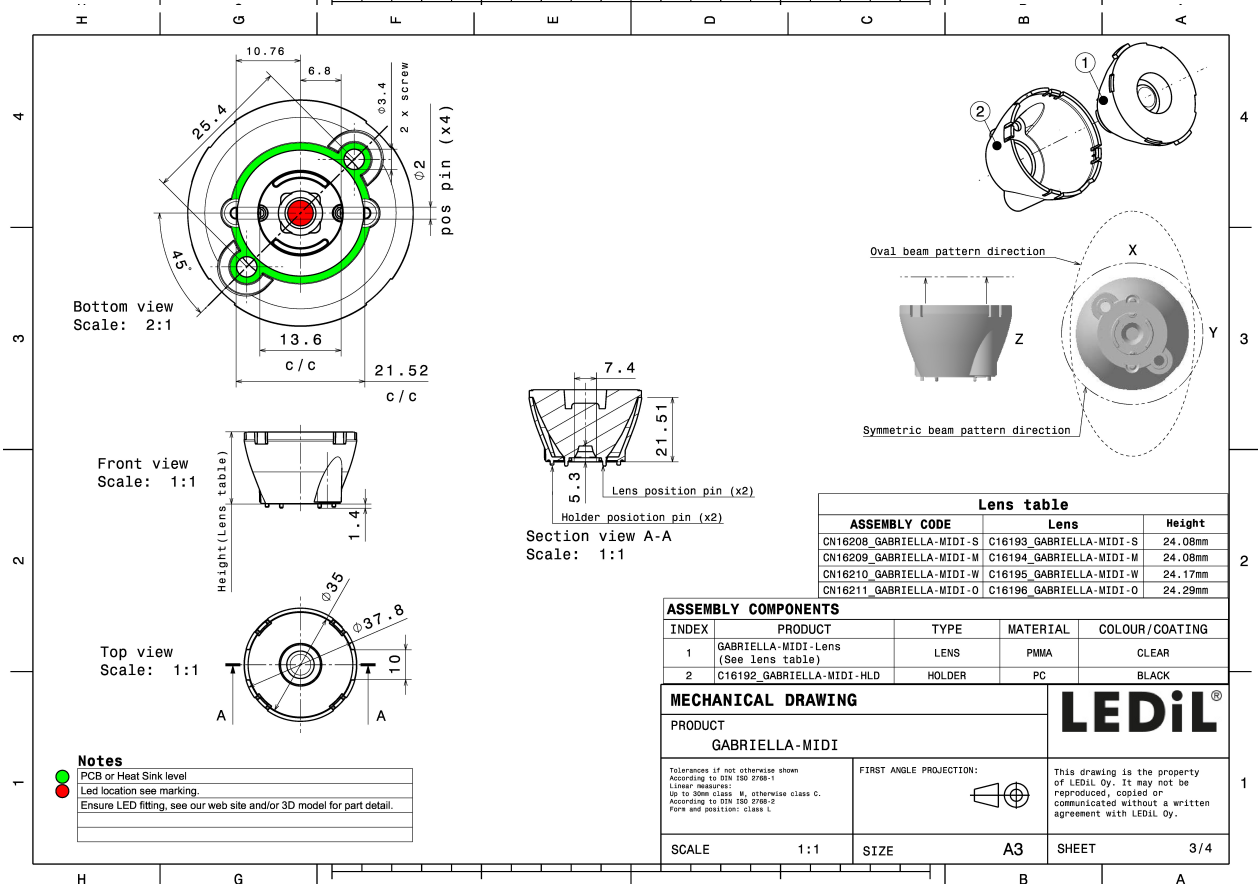
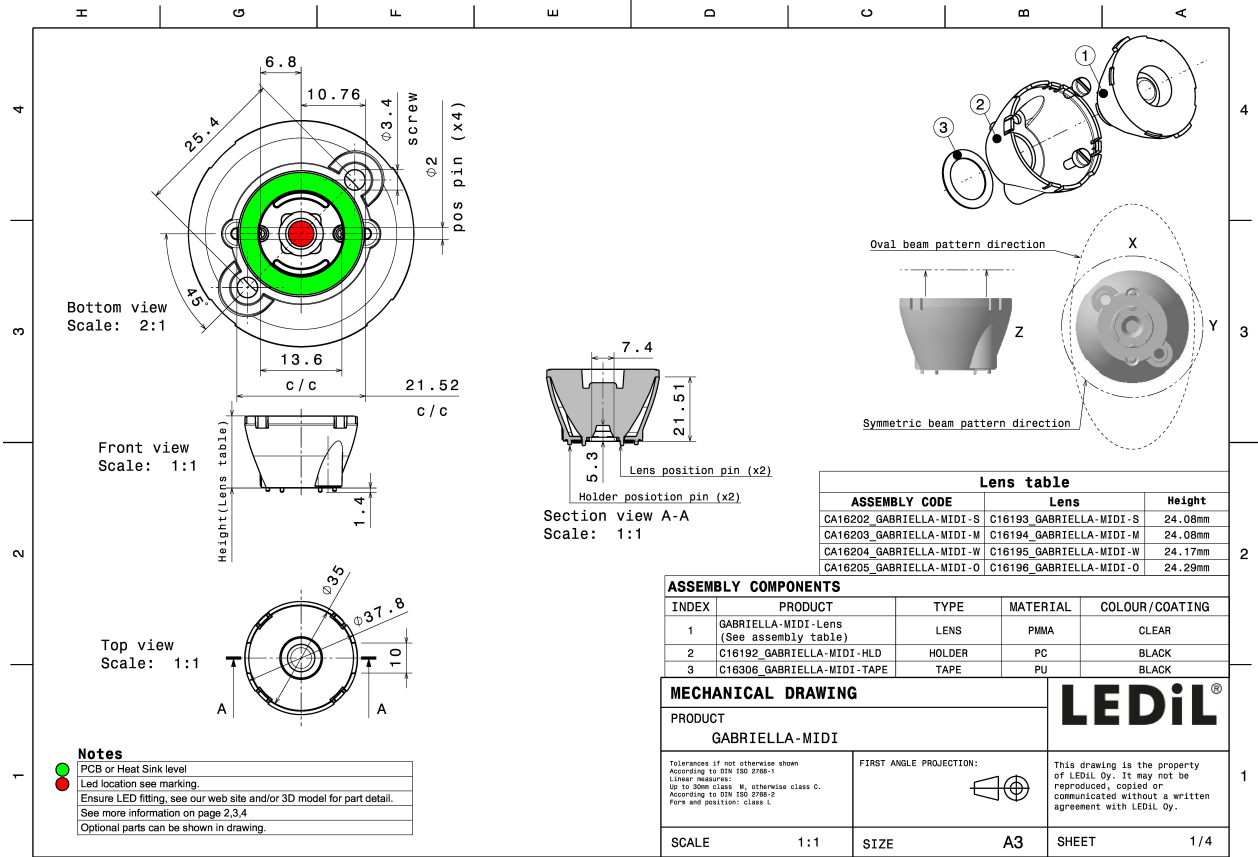

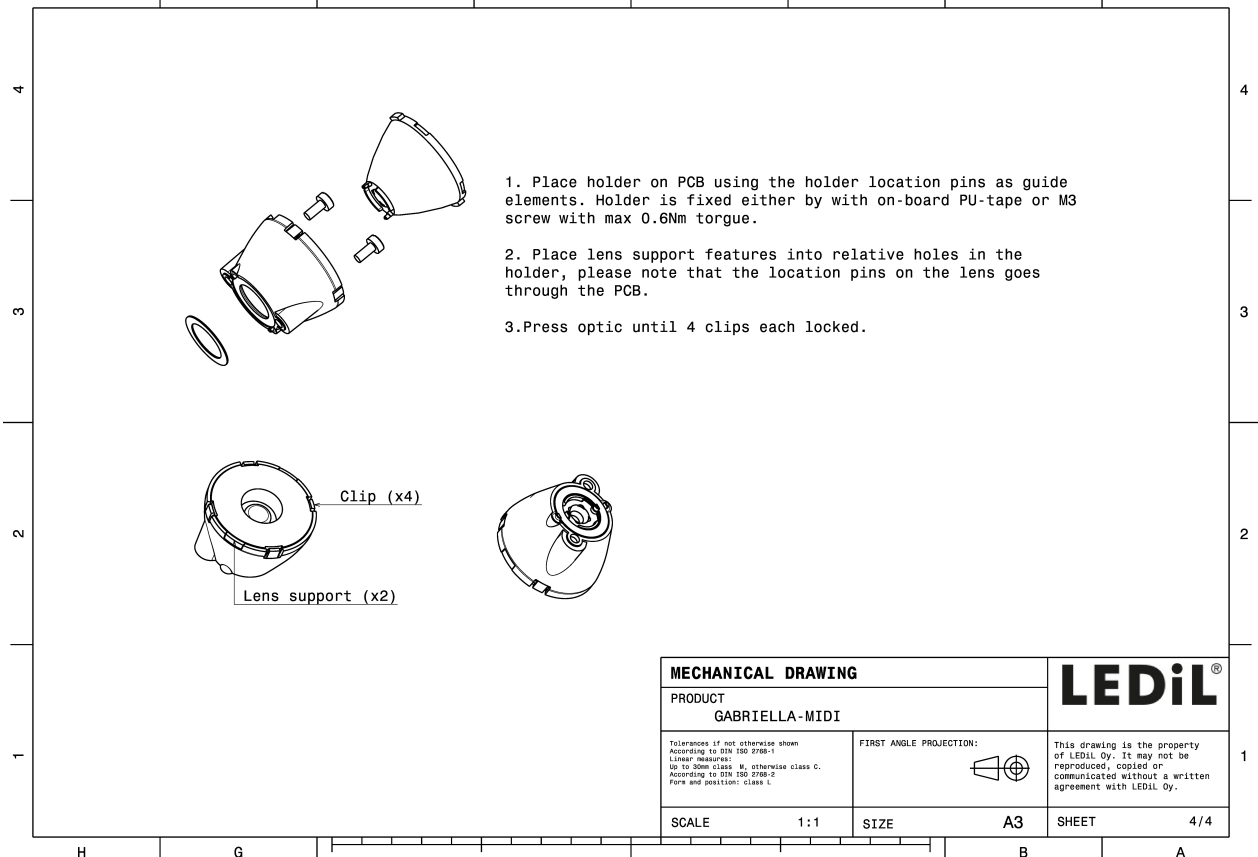
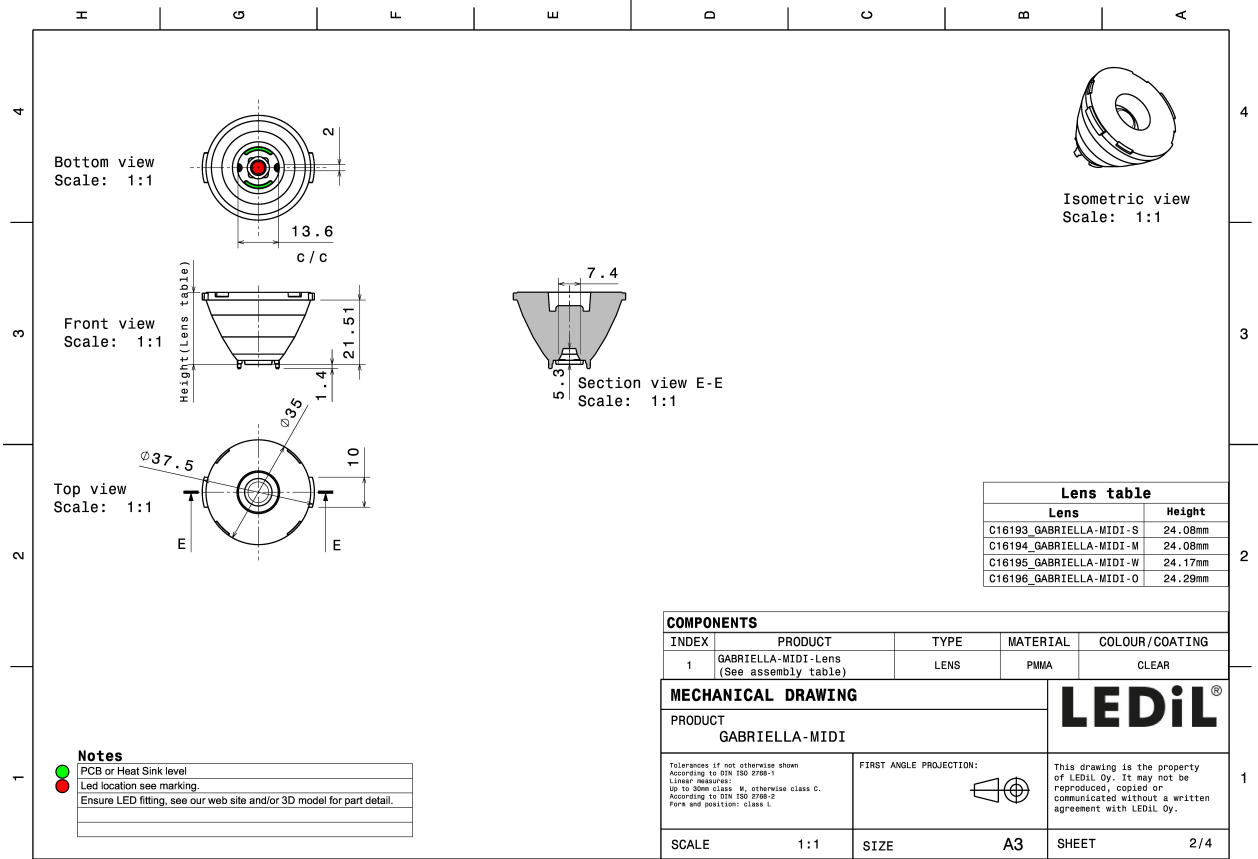

See also our general installation guide: www.ledil.com/installation_guide

OPTICAL RESULTS (MEASURED):



LED XM-L RGBW (XMLDCL HI)
FWHM / FWTM 42.0 + 11.0° / 58.0 + 22.0°
Efficiency 86 %
Peak intensity 5.1 cd/lm
LEDs/each optic 1
Light colour/type RGBW
Required components:

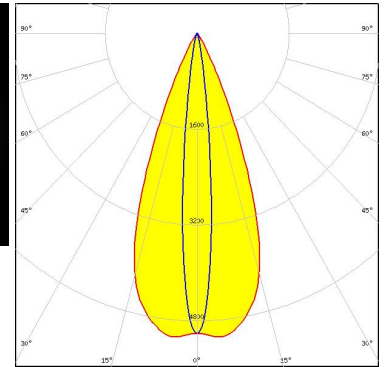

Light distribution files



LED XP-L RGBW HD
FWHM / FWTM 40.0 + 12.0° / 58.0 + 21.0°
Efficiency 88 %
Peak intensity 5.6 cd/lm
LEDs/each optic 1
Light colour/type RGBW
Required components:

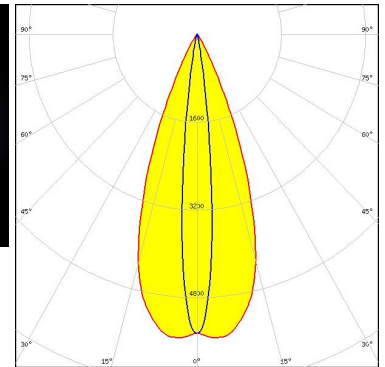

Light distribution files



LED XP-L RGBW HI Blend
FWHM / FWTM 41.0 + 11.0° / 57.0 + 20.0°
Efficiency 83 %
Peak intensity 5.6 cd/lm
LEDs/each optic 1
Light colour/type White
Required components:

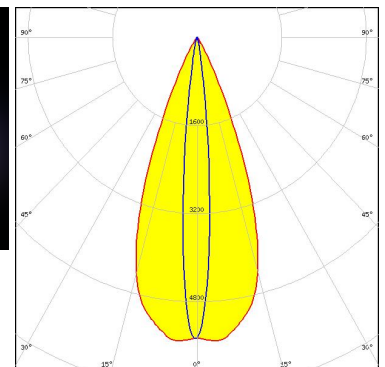
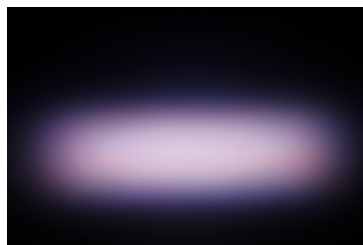

Light distribution files

OPTICAL RESULTS (MEASURED):

OSRAM
Opto Semiconductors

LED OSLON Pure 1414
 FWHM / FWTM 38.0 + 17.0° / 64.0 + 34.0°
 Efficiency 85 %
 Peak intensity 3.3 cd/lm
 LEDs/each optic 4
 Light colour/type RGBW
 Required components:

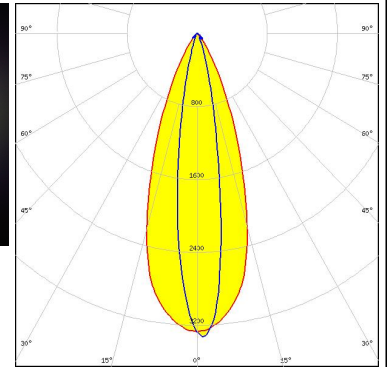

Light distribution files

OSRAM
Opto Semiconductors

LED OSTAR Projection Compact (KW.CSLNM1.TG)
 FWHM / FWTM 42.0 + 9.0° / 54.0 + 16.0°
 Efficiency 90 %
 Peak intensity 7.8 cd/lm
 LEDs/each optic 1
 Light colour/type White
 Required components:

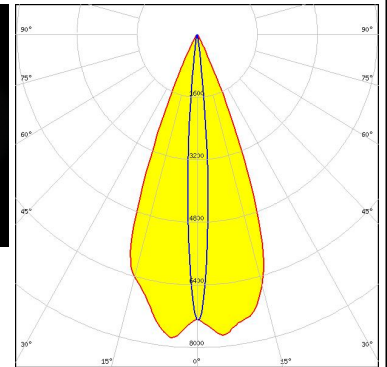
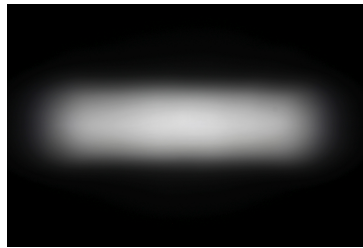

Light distribution files

OSRAM
Opto Semiconductors

LED OSTAR Stage (S2WP)
 FWHM / FWTM 40.0 + 12.0° / 60.0 + 23.0°
 Efficiency 87 %
 Peak intensity 4.9 cd/lm
 LEDs/each optic 1
 Light colour/type RGBW
 Required components:

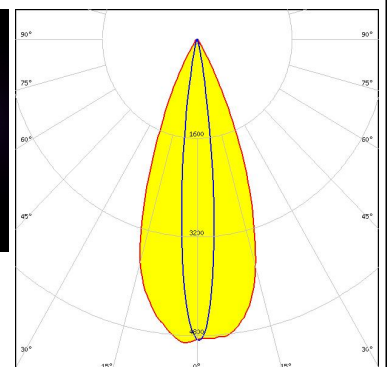
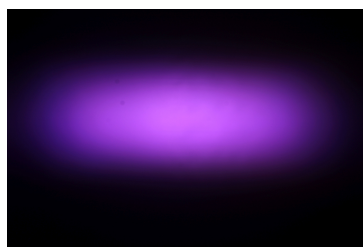

Light distribution files

OPTICAL RESULTS (MEASURED):

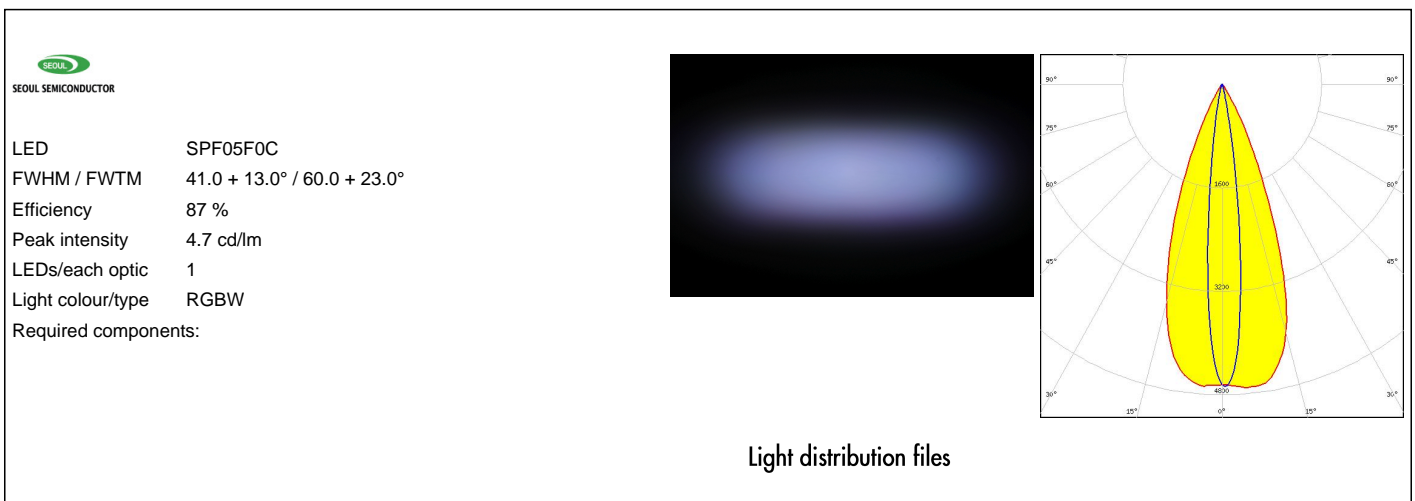
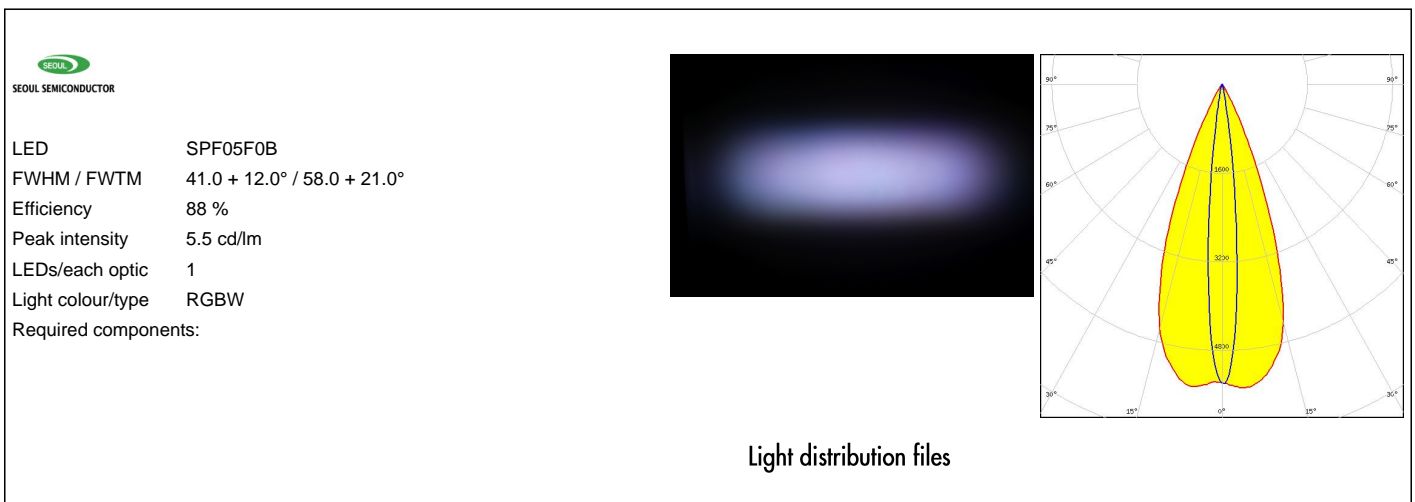
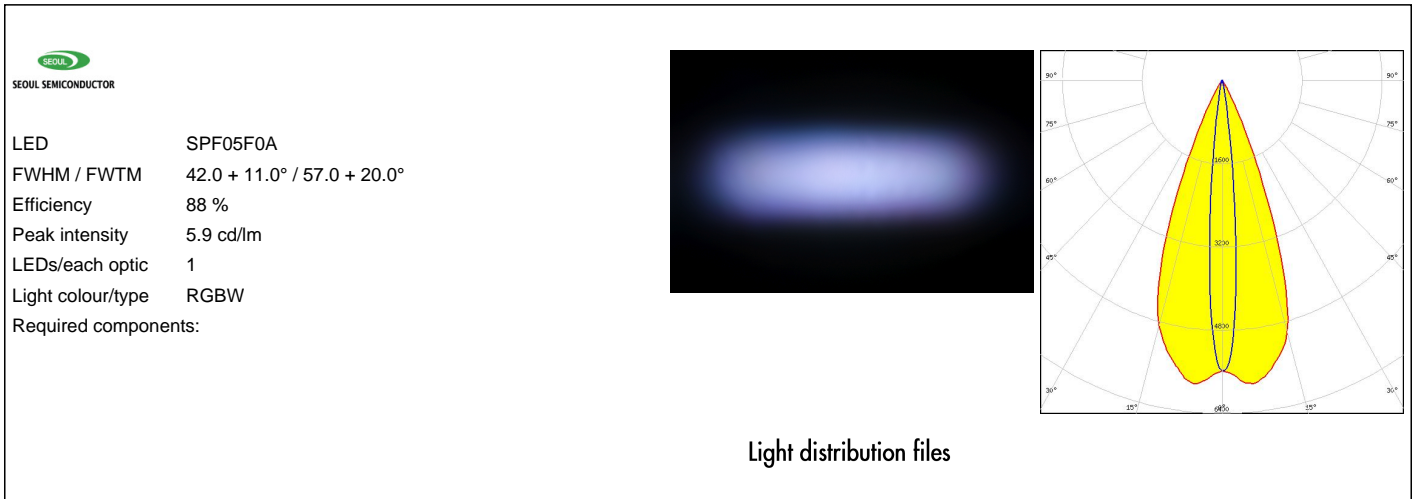

OPTICAL RESULTS (SIMULATED):



LED XHP35 HI
FWHM / FWTM 43.0 + 10.0° / 60.0 + 18.0°
Efficiency 87 %
Peak intensity 5.6 cd/lm
LEDs/each optic 1
Light colour/type White
Required components:

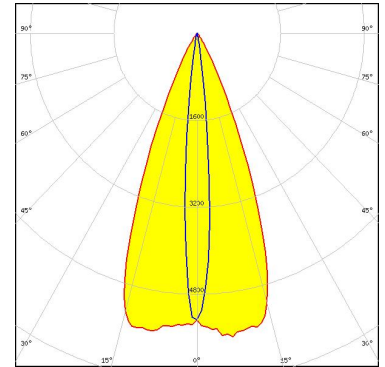

Light distribution files



LED XHP35.2 HD
FWHM / FWTM 42.0 + 10.0° / 61.0 + 21.0°
Efficiency 83 %
Peak intensity 4.5 cd/lm
LEDs/each optic 1
Light colour/type White
Required components:

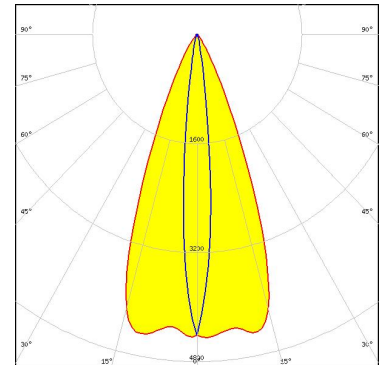

Light distribution files



LED XHP50
FWHM / FWTM 42.0 + 14.0° / 64.0 + 26.0°
Efficiency 84 %
Peak intensity 3.7 cd/lm
LEDs/each optic 1
Light colour/type White
Required components:

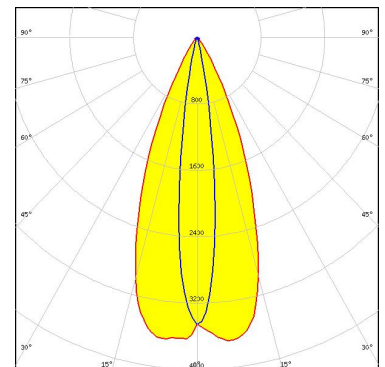

Light distribution files

OPTICAL RESULTS (SIMULATED):



LED XHP50.2
FWHM / FWTM 42.0 + 14.0° / 66.0 + 28.0°
Efficiency 82 %
Peak intensity 3.4 cd/lm
LEDs/each optic 1
Light colour/type White
Required components:

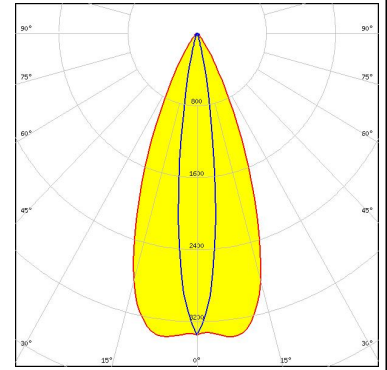

Light distribution files



LED XM-L RGBW (XMLCTW)
FWHM / FWTM 13.0 + 34.0° / 24.0 + 57.0°
Efficiency 86 %
Peak intensity 5.1 cd/lm
LEDs/each optic 1
Light colour/type White
Required components:

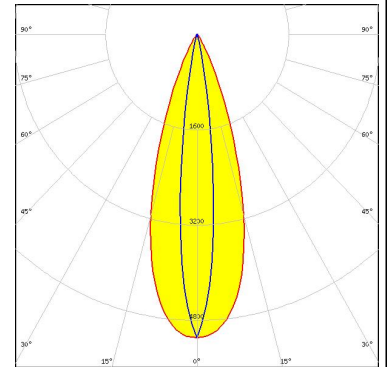

Light distribution files



LED XM-L2
FWHM / FWTM 11.0 + 33.0° / 21.0 + 54.0°
Efficiency 87 %
Peak intensity 6.2 cd/lm
LEDs/each optic 1
Light colour/type White
Required components:

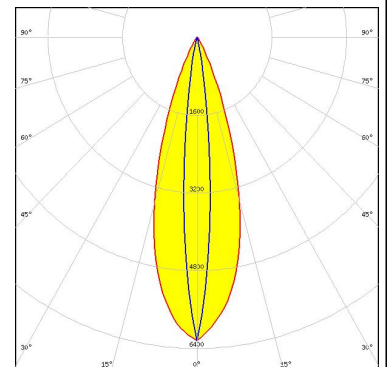

Light distribution files

OPTICAL RESULTS (SIMULATED):



LED XP-G2
 FWHM / FWTM 9.0 + 33.0° / 19.0 + 53.0°
 Efficiency 87 %
 Peak intensity 7.2 cd/lm
 LEDs/each optic 1
 Light colour/type White
 Required components:

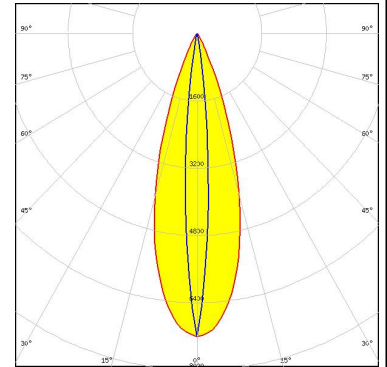

Light distribution files



LED XP-G2 HE
 FWHM / FWTM 42.0 + 10.0° / 60.0 + 19.0°
 Efficiency 86 %
 Peak intensity 5.3 cd/lm
 LEDs/each optic 1
 Light colour/type White
 Required components:

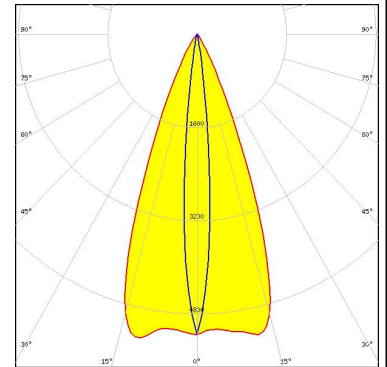

Light distribution files



LED XP-L HI
 FWHM / FWTM 42.0 + 10.0° / 59.0 + 18.0°
 Efficiency 87 %
 Peak intensity 5.9 cd/lm
 LEDs/each optic 1
 Light colour/type White
 Required components:

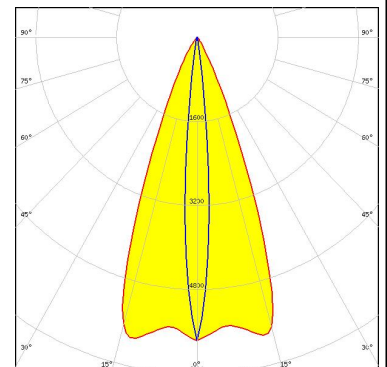

Light distribution files

OPTICAL RESULTS (SIMULATED):



LED LUXEON 5050 Round LES
FWHM / FWTM 12.0 + 44.0° / 22.0 + 64.0°
Efficiency 86 %
Peak intensity 4.3 cd/lm
LEDs/each optic 1
Light colour/type White
Required components:

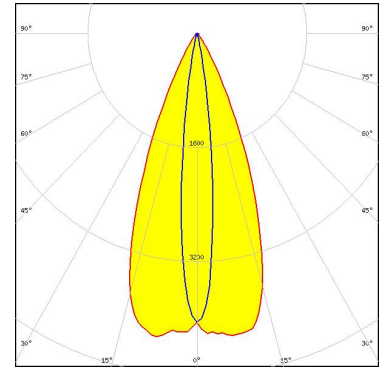

Light distribution files



LED LUXEON M/MX
FWHM / FWTM 15.0 + 33.0° / 28.0 + 58.0°
Efficiency 84 %
Peak intensity 4.2 cd/lm
LEDs/each optic 1
Light colour/type White
Required components:

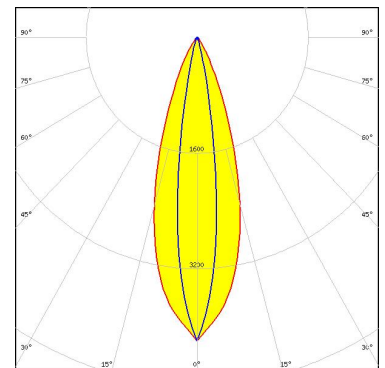

Light distribution files



LED LUXEON MZ
FWHM / FWTM 11.0 + 32.0° / 22.0 + 55.0°
Efficiency 86 %
Peak intensity 6 cd/lm
LEDs/each optic 1
Light colour/type White
Required components:

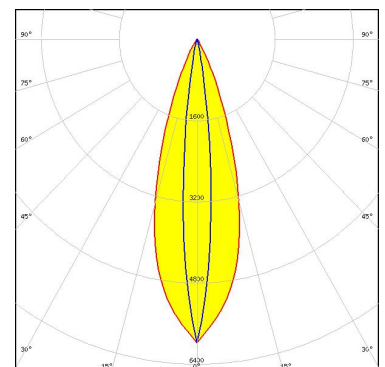

Light distribution files

OPTICAL RESULTS (SIMULATED):



LED NCSxE17A
FWHM / FWTM 42.0 + 12.0° / 64.0 + 24.0°
Efficiency 81 %
Peak intensity 3.8 cd/lm
LEDs/each optic 4
Light colour/type RGBW
Required components:

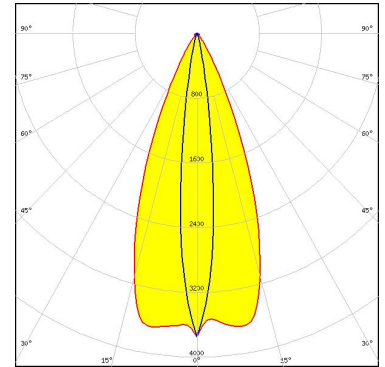

Light distribution files



LED Duris S8
FWHM / FWTM 14.0 + 34.0° / 26.0 + 57.0°
Efficiency 86 %
Peak intensity 4.7 cd/lm
LEDs/each optic 1
Light colour/type White
Required components:

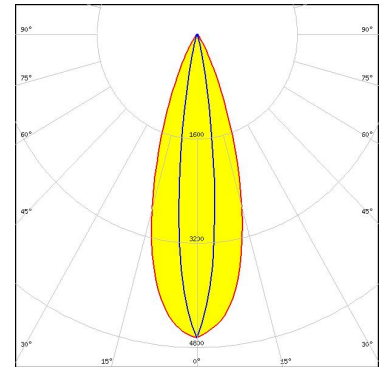

Light distribution files



LED OSLON Square EC
FWHM / FWTM 8.0 + 31.0° / 17.0 + 52.0°
Efficiency 87 %
Peak intensity 7.9 cd/lm
LEDs/each optic 1
Light colour/type White
Required components:

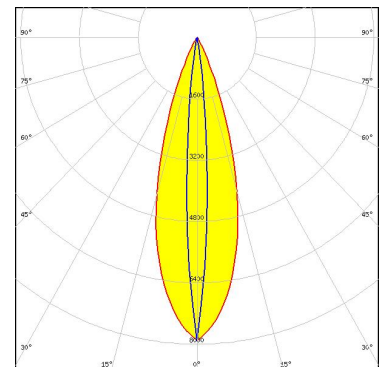

Light distribution files

OPTICAL RESULTS (SIMULATED):

OSRAM
Opto Semiconductors

LED	OSTAR Stage (S2WN)
FWHM / FWTM	9.0 + 38.0° / 17.0 + 57.0°
Efficiency	87 %
Peak intensity	7.2 cd/lm
LEDs/each optic	1
Light colour/type	White
Required components:	

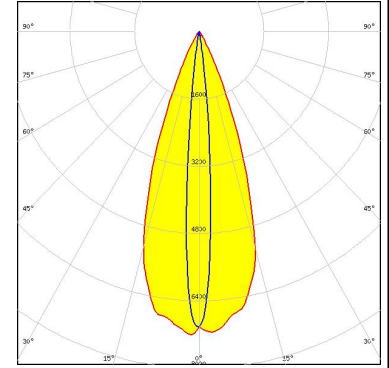

Light distribution files

GENERAL INFORMATION:

NOTE: The typical beam angle will be changed by different color, chip size and chip position tolerance. The typical total beam angle is the full angle measured where the luminous intensity is half of the peak value.

MATERIALS:

As part of our continuous research and improvement processes, and to ensure the best possible quality and availability of our products, LEDiL reserves the right to change material grades without notice.

PRODUCT DATA USER AGREEMENT AND DISCLAIMER:

The measured data in the provided downloadable LEDiL Product Datasheets and Mechanical 2D-Drawings is rounded and provided as reference for planning. LEDiL Oy's optical specifications have been verified by conducting performance testing of the products in accordance with the company's quality system. The reported data are averaged results of multiple measurements with typical variation. LEDiL Oy reserves the right to without prior notification make changes and improvements to its products.

LEDiL Oy assumes neither warranty, nor guarantee nor any other liability of any kind for the contents and correctness of the provided data. The provided data has been generated with highest diligence but the provided data may in reality not represent the complete possible variation range of all intrinsic parameters. Therefore, in certain cases a deviation from the provided data could occur.

LEDiL Oy reserves the right to undertake technical changes of its products without further notification which could lead to changes in the provided data. LEDiL Oy assumes no liability of any kind for the possible deviation from any provided data or any other damage resulting from the usage of the provided data.

The user agrees to this disclaimer and user agreement with the download or usage of the provided files.

LEDiL Oy

Joensuunkatu 7
FI-24100 SALO
Finland

LEDiL Inc.

228 West Page Street
Suite D
Sycamore IL 60178
USA

Ledil Optics Technology (Shenzhen) Co., Ltd.

405 , Block B
Casic Motor Building
Shenzhen 518057
P.R.CHINA

Local sales and technical support

[www.ledil.com/
where_to_buy](http://www.ledil.com/where_to_buy)

Shipping locations

Poznan, Poland
Hong Kong, China

Distribution Partners

[www.ledil.com/
where_to_buy](http://www.ledil.com/where_to_buy)