

LINNEA-O

~35° + 70° oval beam optimized for 1.0 mm metal sheet or profile. Variant made from PC.

SPECIFICATION:

| | |
|----------------|--------------|
| Dimensions | 285.0 x 40.0 |
| Height | 10.5 mm |
| Fastening | pin |
| ROHS compliant | yes ⓘ |

MATERIALS:

| Component | Type | Material | Colour | Finish | Length (mm) |
|-----------|-------------|----------|--------|--------|-------------|
| LINNEA-O | Linear lens | PC | clear | | |

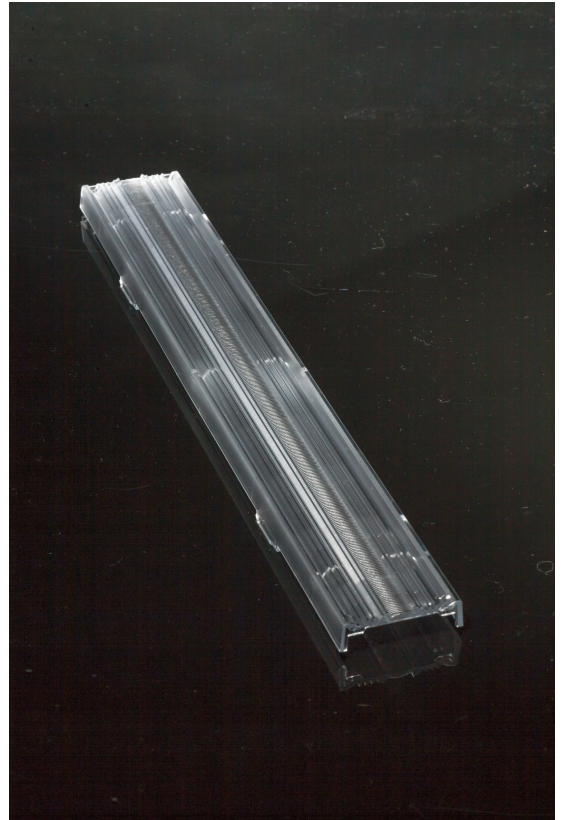

ORDERING INFORMATION:

| Component | Qty in box | MOQ | MPQ | Box weight (kg) |
|---|------------|-----|-----|-----------------|
| F15756_LINNEA-O » Box size: 398 x 298 x 265 mm | 153 | 36 | 9 | 8.0 |

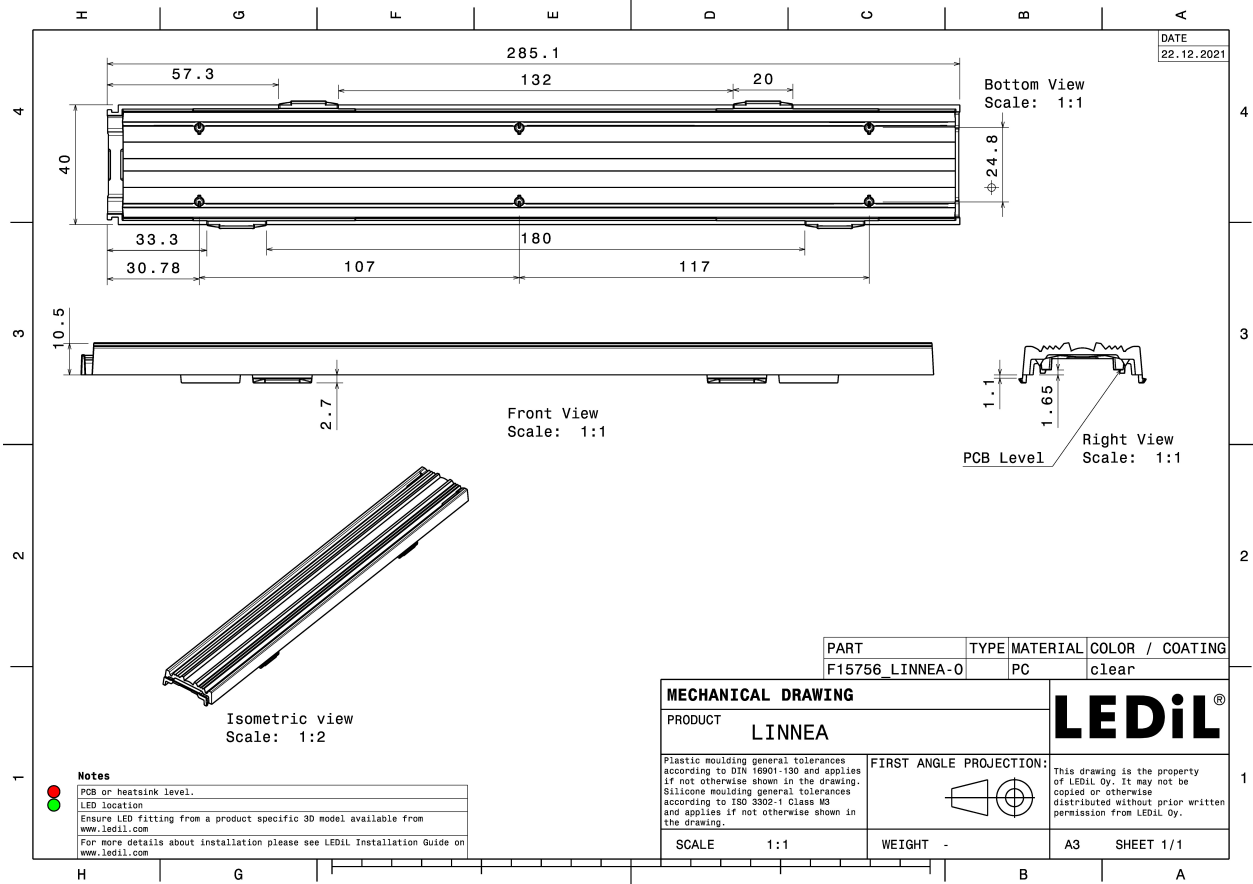

See also our general installation guide: www.ledil.com/installation_guide

OPTICAL RESULTS (MEASURED):



LED CALOSNU405-M7W1
 FWHM / FWTM 88.0 + 35.0° / 137.0 + 84.0°
 Efficiency 82 %
 Peak intensity 0.8 cd/lm
 LEDs/each optic 1
 Light colour/type White
 Required components:

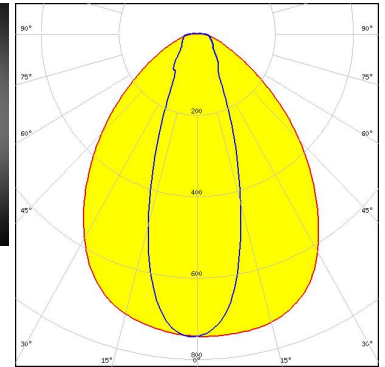
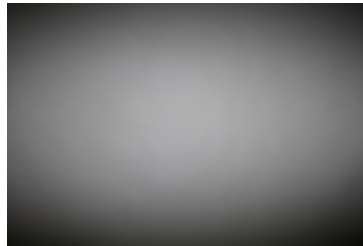

Light distribution files



LED CALOSNU410-M7W1
 FWHM / FWTM 88.0 + 35.0° / 136.0 + 83.0°
 Efficiency 82 %
 Peak intensity 0.8 cd/lm
 LEDs/each optic 1
 Light colour/type White
 Required components:

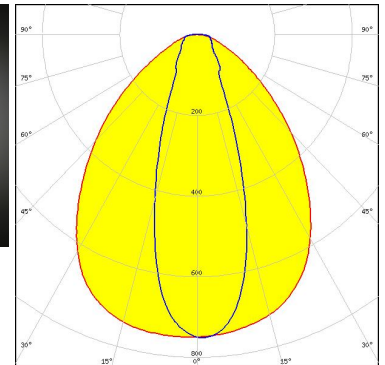
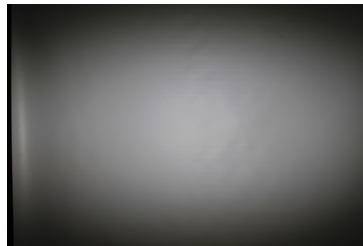

Light distribution files



LED XP-E
 FWHM / FWTM 90.0 + 35.0° / 138.0 + 86.0°
 Efficiency 81 %
 Peak intensity 0.7 cd/lm
 LEDs/each optic 1
 Light colour/type White
 Required components:

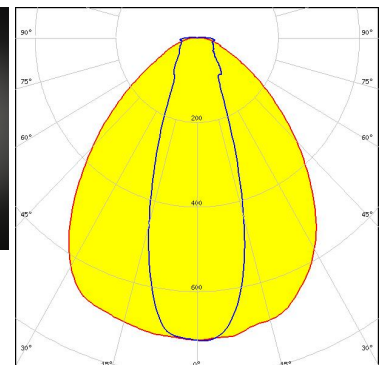
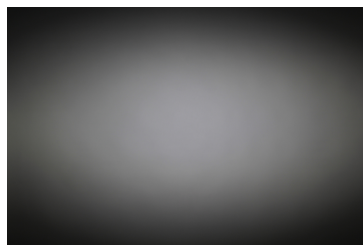

Light distribution files

OPTICAL RESULTS (MEASURED):

Helvar

LED L-iC-282-827-865-011A
 FWHM / FWTM 91.0 + 39.0° / 139.0 + 84.0°
 Efficiency 83 %
 Peak intensity 0.7 cd/lm
 LEDs/each optic 1
 Light colour/type White
 Required components:

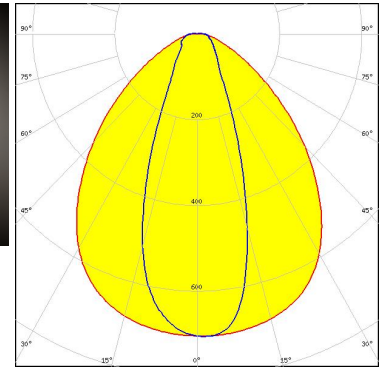
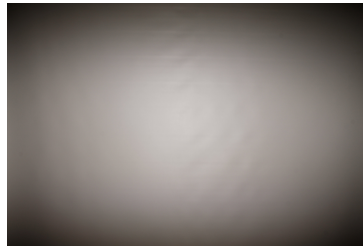

Light distribution files

Helvar

LED LP-282-840-009A 60/300
 FWHM / FWTM 91.0 + 39.0° / 139.0 + 85.0°
 Efficiency 83 %
 Peak intensity 0.7 cd/lm
 LEDs/each optic 1
 Light colour/type White
 Required components:

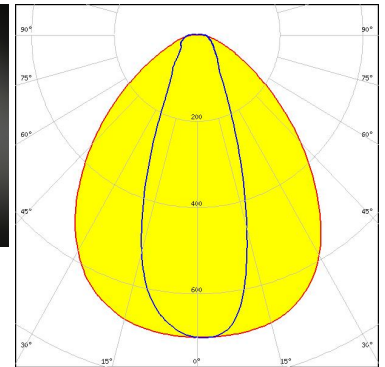
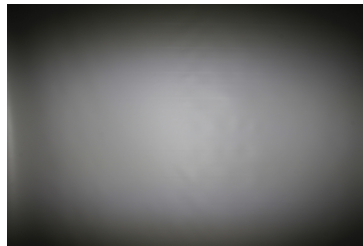

Light distribution files

Helvar

LED LS-282-840-011A
 FWHM / FWTM 92.0 + 39.0° / 140.0 + 86.0°
 Efficiency 82 %
 Peak intensity 0.7 cd/lm
 LEDs/each optic 1
 Light colour/type White
 Required components:

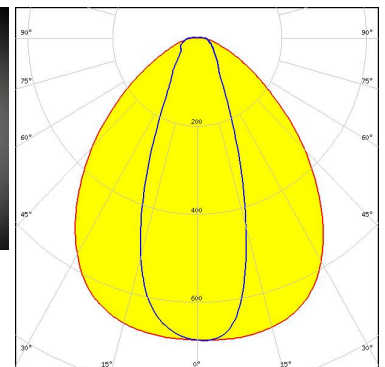
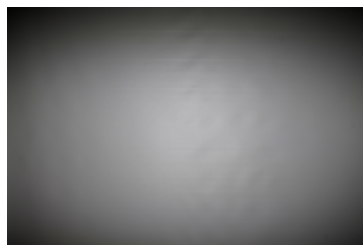

Light distribution files

OPTICAL RESULTS (MEASURED):

Helvar

LED LX-282-840-023A
 FWHM / FWTM 91.0 + 39.0° / 139.0 + 86.0°
 Efficiency 83 %
 Peak intensity 0.7 cd/lm
 LEDs/each optic 1
 Light colour/type White
 Required components:

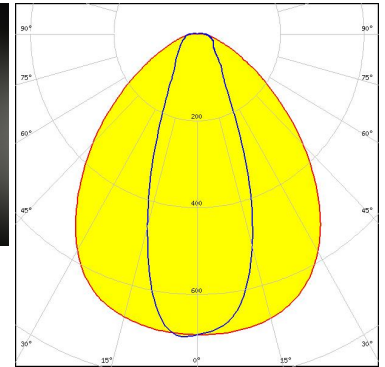
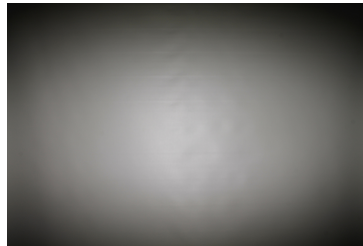

Light distribution files

inventronics

LED PL-LIN-IND-Z1 2800 560x24
 FWHM / FWTM 91.0 + 39.0° / 140.0 + 94.0°
 Efficiency 87 %
 Peak intensity 0.7 cd/lm
 LEDs/each optic 1
 Light colour/type White
 Required components:

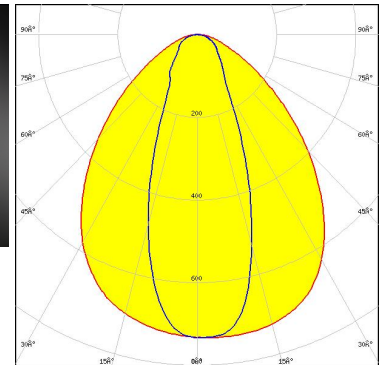
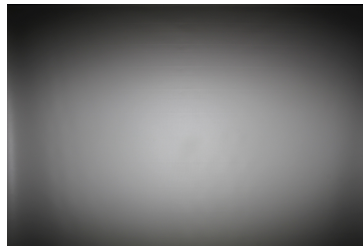

Light distribution files

inventronics

LED PL-LIN-Z5 1100 280x20
 FWHM / FWTM 91.0 + 38.0° / 139.0 + 85.0°
 Efficiency 83 %
 Peak intensity 0.7 cd/lm
 LEDs/each optic 1
 Light colour/type White
 Required components:

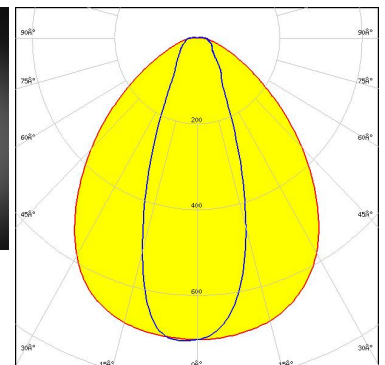
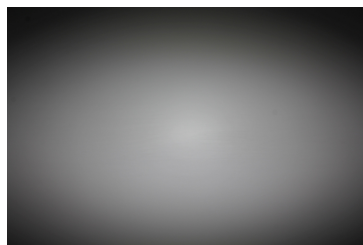

Light distribution files

OPTICAL RESULTS (MEASURED):

inventronics

LED PL-LIN-Z5 2000 280x20
 FWHM / FWTM 92.0 + 39.0° / 140.0 + 85.0°
 Efficiency 83 %
 Peak intensity 0.7 cd/lm
 LEDs/each optic 1
 Light colour/type White
 Required components:

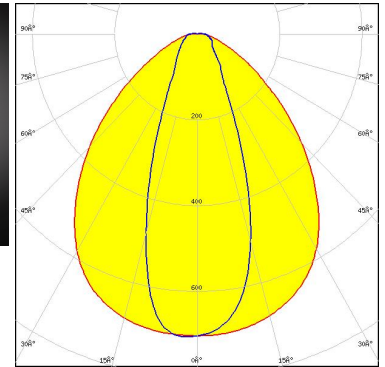

Light distribution files

LUMITRONIX[®]
 High-Performance LED-Technologies & Solutions

LED LinearZ 280-112 Circadian TW
 FWHM / FWTM 81.0 + 56.0° / 142.0 + 111.0°
 Efficiency 84 %
 Peak intensity 0.6 cd/lm
 LEDs/each optic 1
 Light colour/type Tunable White
 Required components:

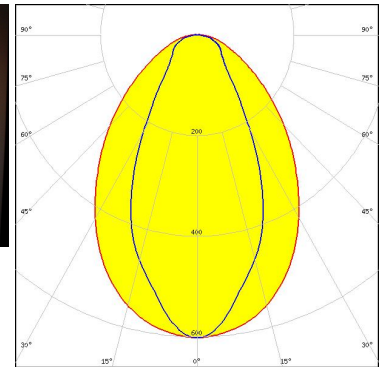
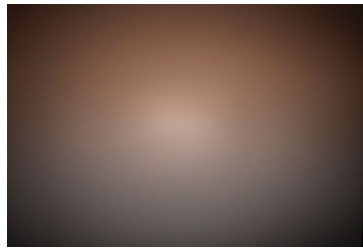

Light distribution files

LUMITRONIX[®]
 High-Performance LED-Technologies & Solutions

LED LinearZ 280-26
 FWHM / FWTM 89.0 + 39.0° / 140.0 + 89.0°
 Efficiency 84 %
 Peak intensity 0.7 cd/lm
 LEDs/each optic 1
 Light colour/type White
 Required components:

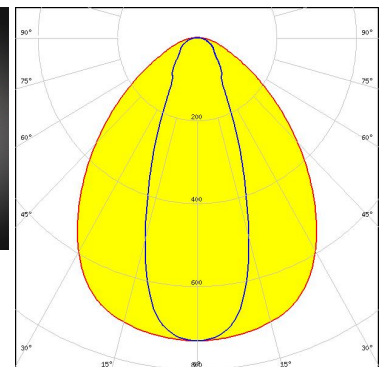
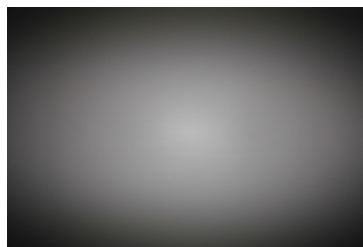

Light distribution files

OPTICAL RESULTS (MEASURED):



LED LinearZ 280-40 TW
FWHM / FWTM 90.0 + 38.0° / 140.0 + 89.0°
Efficiency 84 %
Peak intensity 0.7 cd/lm
LEDs/each optic 1
Light colour/type Tunable White
Required components:

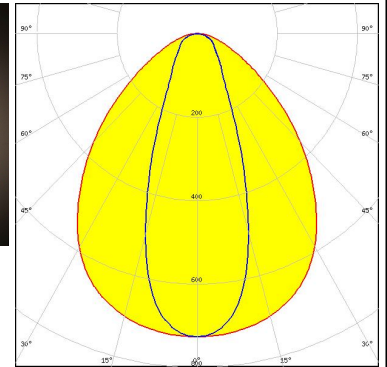
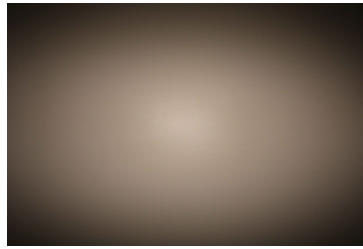

Light distribution files



LED LinLED 280x24mm 1100lm 830 2C 30V LINNEA-GC G1
FWHM / FWTM 91.0 + 39.0° / 139.0 + 84.0°
Efficiency 82 %
Peak intensity 0.7 cd/lm
LEDs/each optic 1
Light colour/type White
Required components:

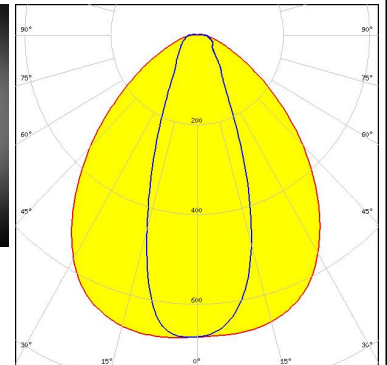
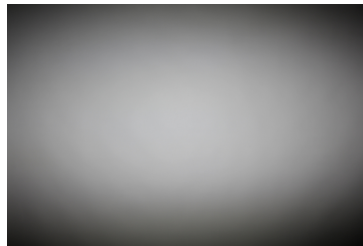

Light distribution files



LED NF2x757G
FWHM / FWTM 86.0 + 33.0° / 136.0 + 84.0°
Efficiency 82 %
Peak intensity 0.8 cd/lm
LEDs/each optic 1
Light colour/type White
Required components:

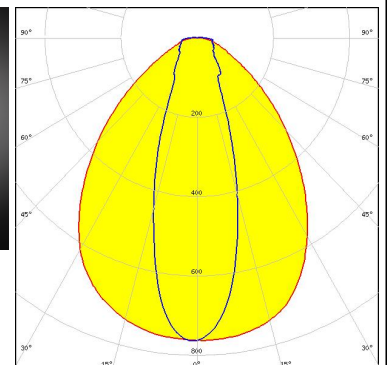
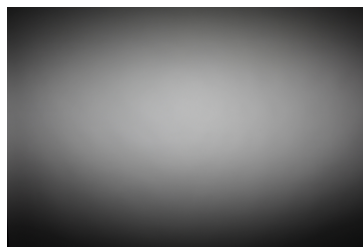

Light distribution files

OPTICAL RESULTS (MEASURED):



LED NFSW757H
FWHM / FWTM 92.0 + 41.0° / 140.0 + 89.0°
Efficiency 85 %
Peak intensity 0.7 cd/lm
LEDs/each optic 1
Light colour/type White
Required components:

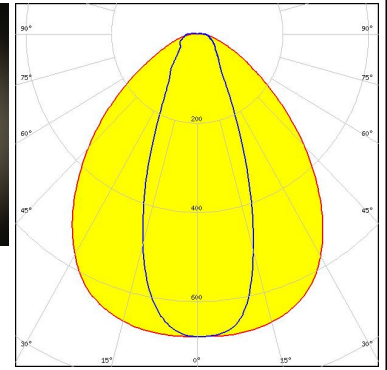

Light distribution files



LED NFSx757G
FWHM / FWTM 87.0 + 38.0° / 140.0 + 85.0°
Efficiency 81 %
Peak intensity 0.7 cd/lm
LEDs/each optic 1
Light colour/type White
Required components:

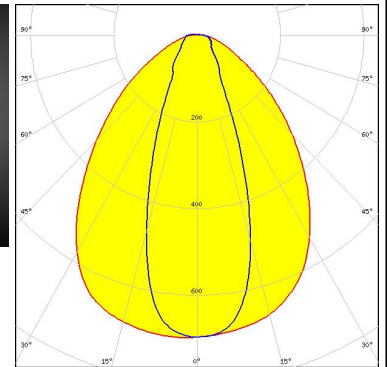

Light distribution files



LED DURIS S5 (2 chip)
FWHM / FWTM 90.0 + 38.0° / 138.0 + 86.0°
Efficiency 83 %
Peak intensity 0.7 cd/lm
LEDs/each optic 1
Light colour/type White
Required components:

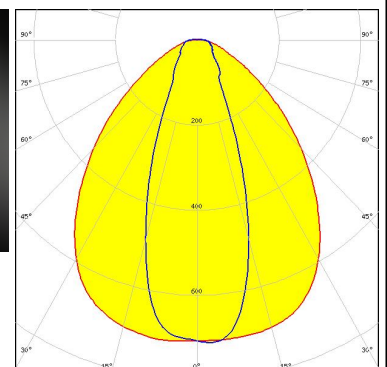
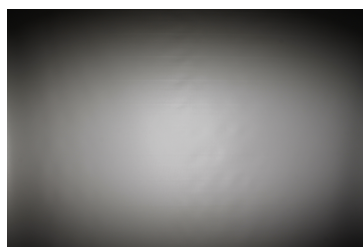

Light distribution files

OPTICAL RESULTS (MEASURED):

OSRAM
Opto Semiconductors

LED DURIS S5 (Single chip)
FWHM / FWTM 91.0 + 38.0° / 139.0 + 88.0°
Efficiency 85 %
Peak intensity 0.7 cd/lm
LEDs/each optic 1
Light colour/type White
Required components:

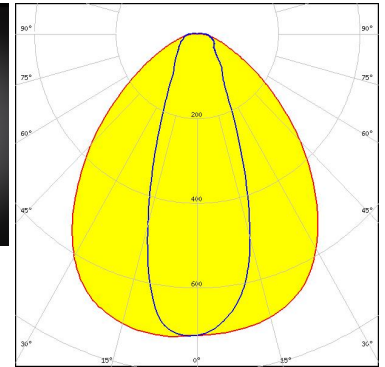
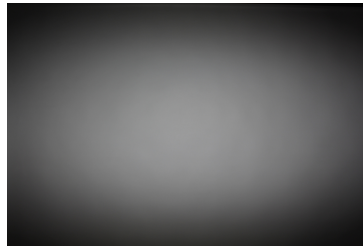

Light distribution files

PHILIPS

LED Fortimo LED Strip 1ft 1100lm FC HV4 & LV4
FWHM / FWTM 92.0 + 40.0° / 140.0 + 85.0°
Efficiency 83 %
Peak intensity 0.7 cd/lm
LEDs/each optic 1
Light colour/type White
Required components:

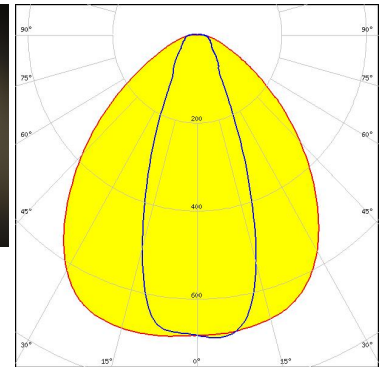
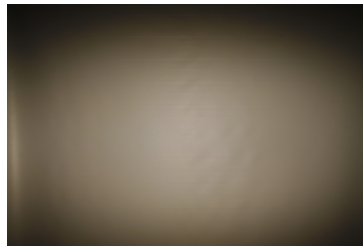

Light distribution files

PHILIPS

LED Fortimo LED Strip 1ft 1100lm FC HV5 & LV5
FWHM / FWTM 89.0 + 38.0° / 140.0 + 92.0°
Efficiency 86 %
Peak intensity 0.7 cd/lm
LEDs/each optic 1
Light colour/type White
Required components:

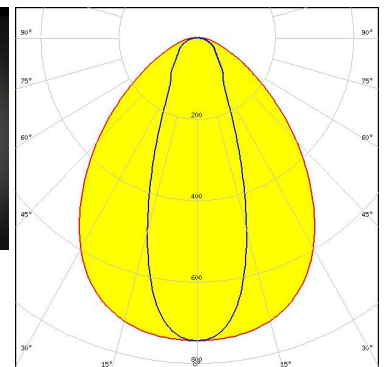
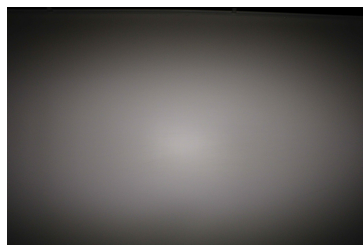

Light distribution files

OPTICAL RESULTS (MEASURED):

PHILIPS

LED Fortimo LED Strip 1ft 650lm FC HV4 & LV4
FWHM / FWTM 93.0 + 40.0° / 140.0 + 85.0°
Efficiency 83 %
Peak intensity 0.7 cd/lm
LEDs/each optic 1
Light colour/type White
Required components:

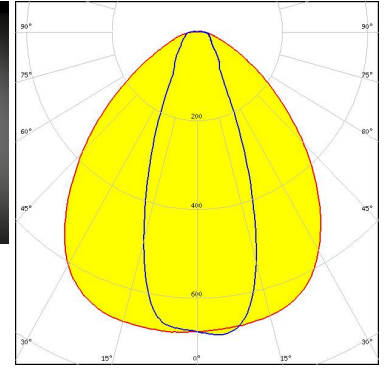
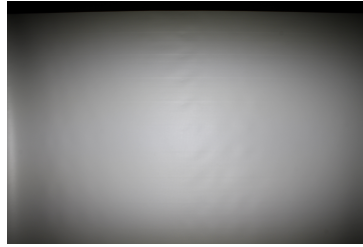

Light distribution files

PHILIPS

LED Fortimo LED Strip 1ft 650lm FC HV5 & LV5
FWHM / FWTM 85.0 + 33.0° / 136.0 + 90.0°
Efficiency 85 %
Peak intensity 0.8 cd/lm
LEDs/each optic 1
Light colour/type White
Required components:

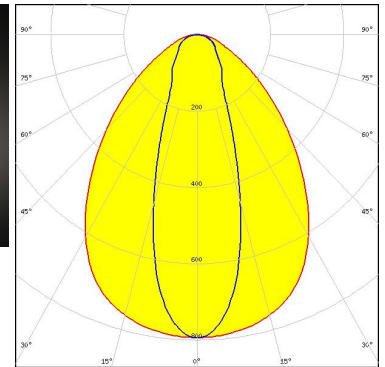
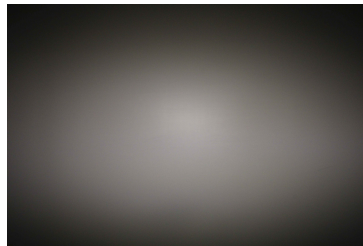

Light distribution files

SAMSUNG

LED LM28xB Series
FWHM / FWTM 88.0 + 33.0° / 137.0 + 84.0°
Efficiency 83 %
Peak intensity 0.5 cd/lm
LEDs/each optic 1
Light colour/type White
Required components:

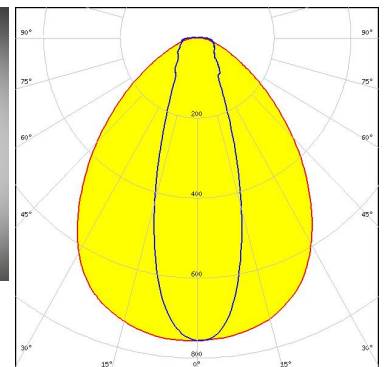
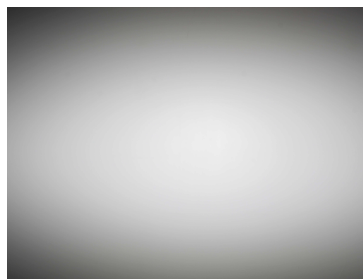

Light distribution files

OPTICAL RESULTS (MEASURED):

SAMSUNG

LED LM561B Plus
FWHM / FWTM 91.0 + 39.0° / 139.0 + 84.0°
Efficiency 82 %
Peak intensity 0.7 cd/lm
LEDs/each optic 1
Light colour/type White
Required components:

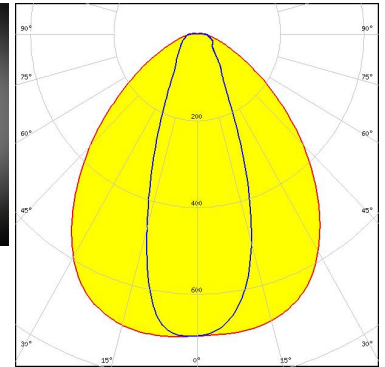
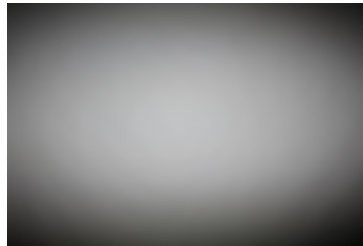

Light distribution files

SAMSUNG

LED LT-H282C
FWHM / FWTM 88.0 + 33.0° / 136.0 + 84.0°
Efficiency 83 %
Peak intensity 0.8 cd/lm
LEDs/each optic 1
Light colour/type White
Required components:

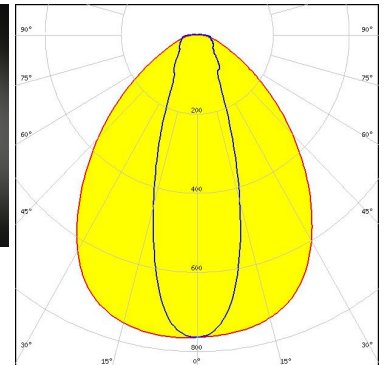
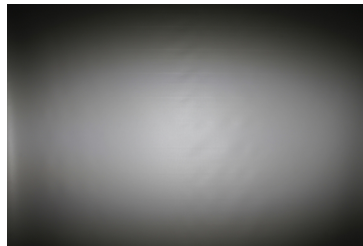

Light distribution files

SAMSUNG

LED LT-H562C
FWHM / FWTM 88.0 + 33.0° / 136.0 + 84.0°
Efficiency 83 %
Peak intensity 0.8 cd/lm
LEDs/each optic 1
Light colour/type White
Required components:

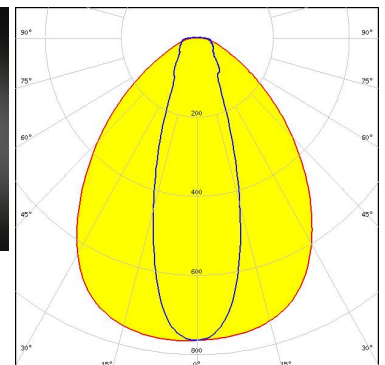
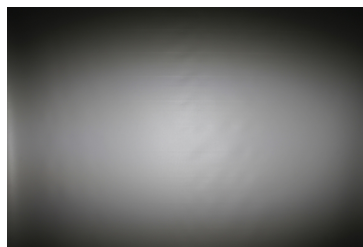

Light distribution files

OPTICAL RESULTS (MEASURED):

SAMSUNG

LED LT-Q282B
 FWHM / FWTM 86.0 + 33.0° / 136.0 + 84.0°
 Efficiency 83 %
 Peak intensity 0.8 cd/m
 LEDs/each optic 1
 Light colour/type White
 Required components:

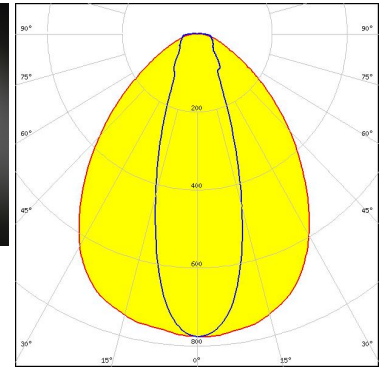
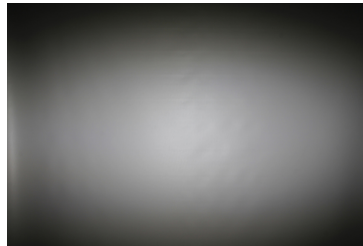

Light distribution files

SAMSUNG

LED LT-S282H
 FWHM / FWTM 87.0 + 33.0° / 136.0 + 84.0°
 Efficiency 83 %
 Peak intensity 0.8 cd/m
 LEDs/each optic 1
 Light colour/type White
 Required components:

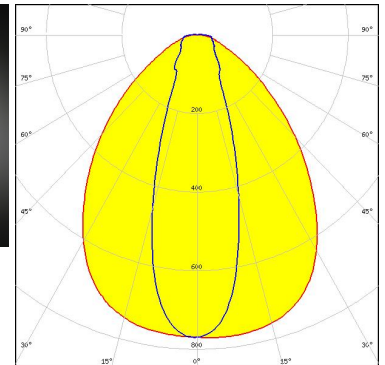
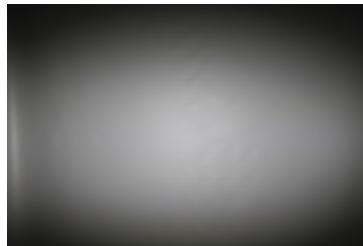

Light distribution files

SAMSUNG

LED LT-S562H
 FWHM / FWTM 87.0 + 33.0° / 136.0 + 84.0°
 Efficiency 83 %
 Peak intensity 0.8 cd/m
 LEDs/each optic 1
 Light colour/type White
 Required components:

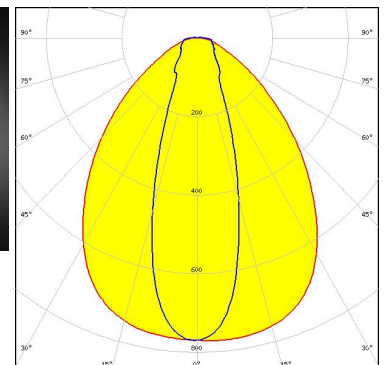
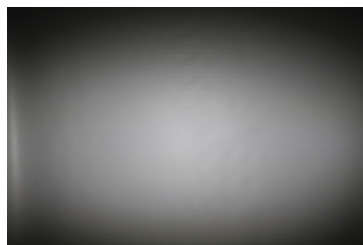

Light distribution files

OPTICAL RESULTS (MEASURED):

SAMSUNG

LED LT-V282E
 FWHM / FWTM 87.0 + 33.0° / 136.0 + 84.0°
 Efficiency 83 %
 Peak intensity 0.8 cd/lm
 LEDs/each optic 1
 Light colour/type White
 Required components:

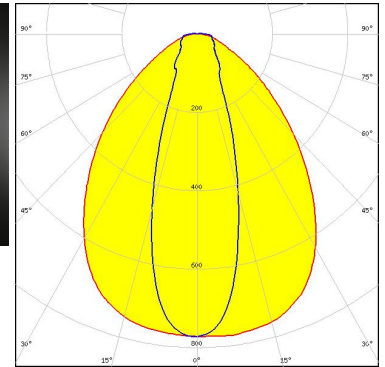
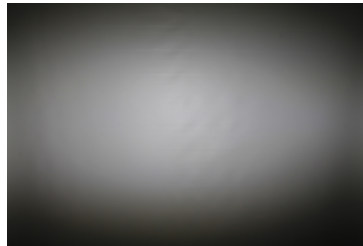

Light distribution files

SAMSUNG

LED LT-V562E
 FWHM / FWTM 87.0 + 33.0° / 136.0 + 84.0°
 Efficiency 83 %
 Peak intensity 0.8 cd/lm
 LEDs/each optic 1
 Light colour/type White
 Required components:

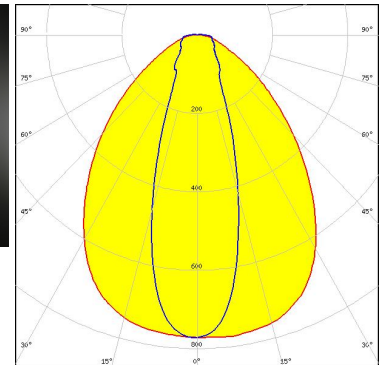
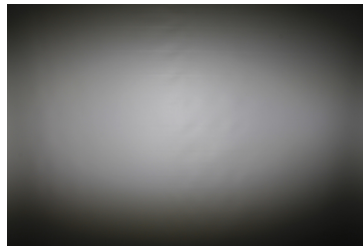

Light distribution files



LED SEOUL 5630D
 FWHM / FWTM 91.0 + 38.0° / 139.0 + 86.0°
 Efficiency 82 %
 Peak intensity 0.7 cd/lm
 LEDs/each optic 1
 Light colour/type White
 Required components:

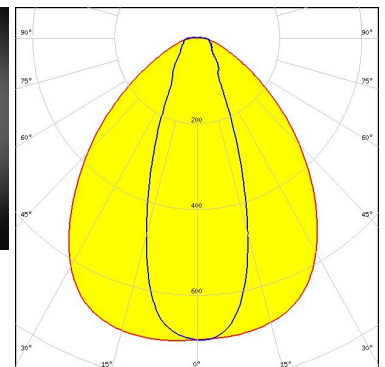
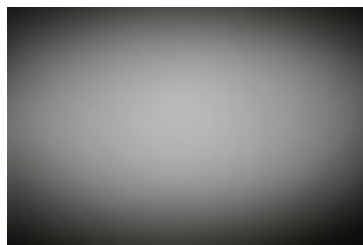

Light distribution files

OPTICAL RESULTS (MEASURED):

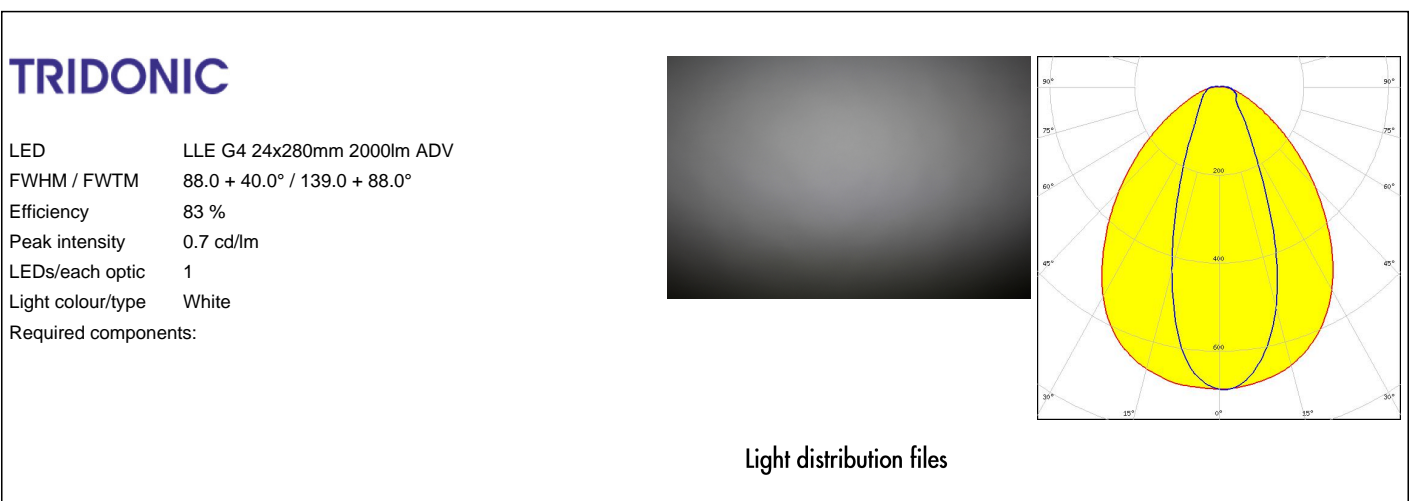
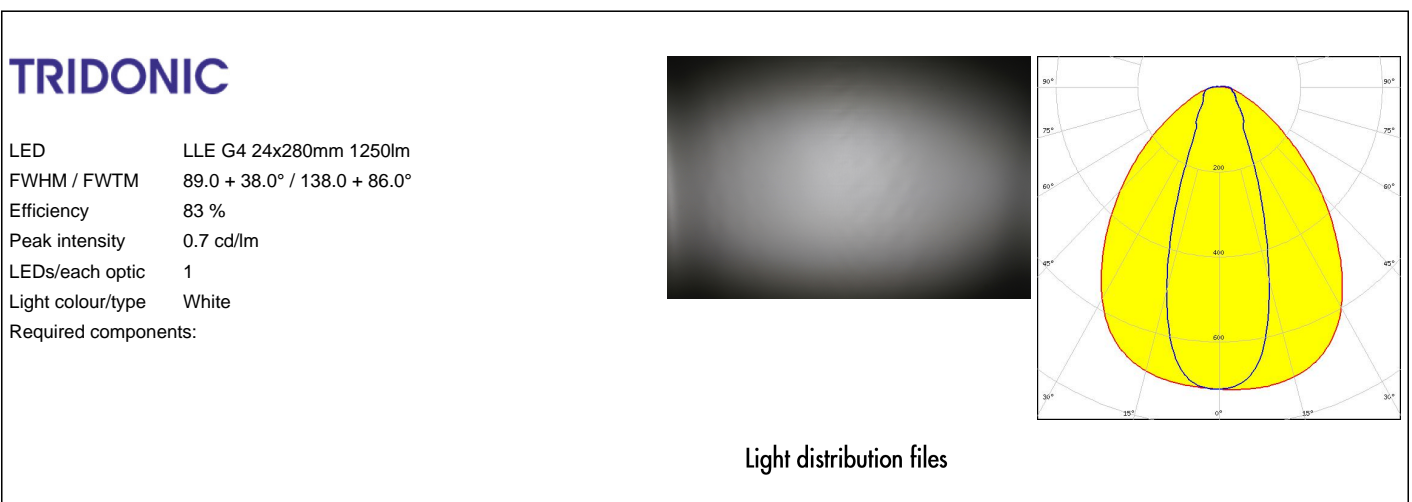
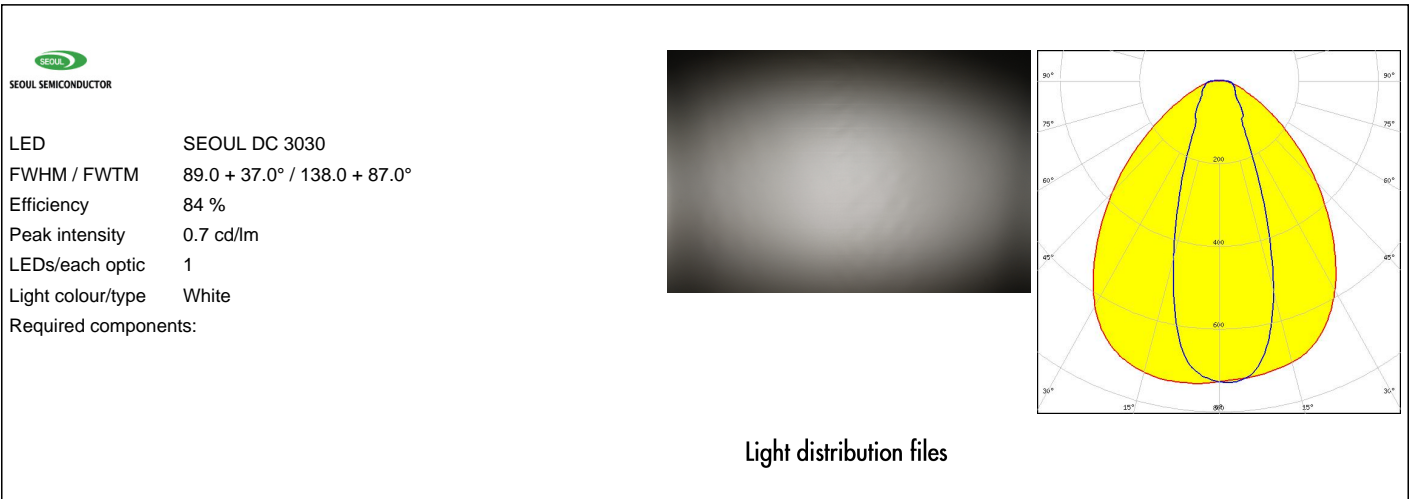

OPTICAL RESULTS (MEASURED):

TRIDONIC

LED LLE G4 24x280mm 650lm
FWHM / FWTM 90.0 + 39.0° / 138.0 + 87.0°
Efficiency 84 %
Peak intensity 0.7 cd/lm
LEDs/each optic 1
Light colour/type White
Required components:

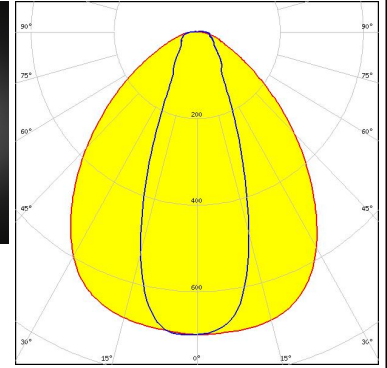
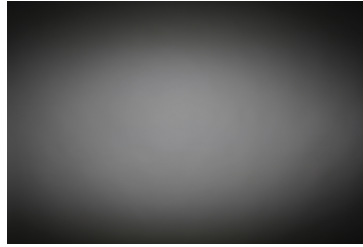

Light distribution files

OPTICAL RESULTS (SIMULATED):



LED Bridgelux SMD 2835
FWHM / FWTM 82.0 + 33.0° / 125.0 + 52.0°
Efficiency 79 %
Peak intensity 0.9 cd/lm
LEDs/each optic 1
Light colour/type White
Required components:

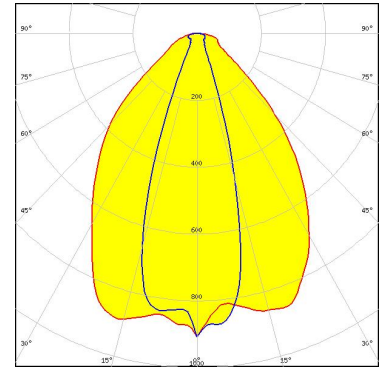

Light distribution files



LED NF2x757G
FWHM / FWTM 34.0 + 75.0° / 60.0 + 128.0°
Efficiency 83 %
Peak intensity 0.9 cd/lm
LEDs/each optic 1
Light colour/type White
Required components:

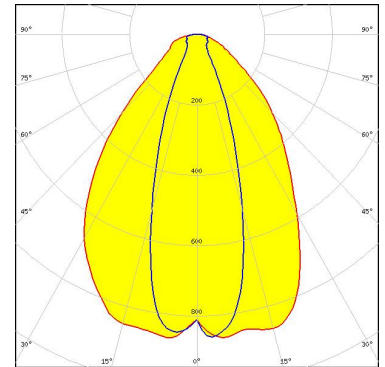

Light distribution files



LED NF2x757G
FWHM / FWTM 81.0 + 34.0° / 125.0 + 52.0°
Efficiency 78 %
Peak intensity 0.9 cd/lm
LEDs/each optic 1
Light colour/type White
Required components:

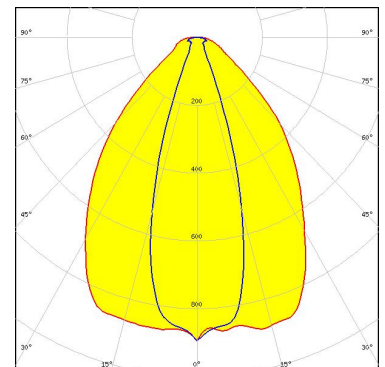

Light distribution files

OPTICAL RESULTS (SIMULATED):

| | |
|--|------------------------------|
|  SEOUL SEMICONDUCTOR | |
| LED | SEOUL DC 3030C |
| FWHM / FWTM | 82.0 + 34.0° / 134.0 + 60.0° |
| Efficiency | 84 % |
| Peak intensity | 0.9 cd/lm |
| LEDs/each optic | 1 |
| Light colour/type | White |
| Required components: | |

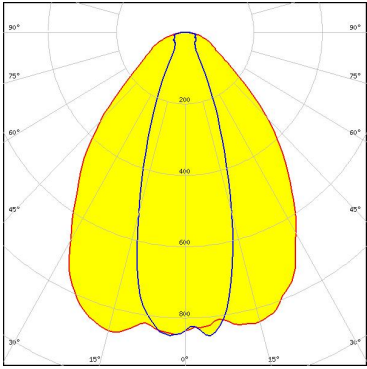

Light distribution files

GENERAL INFORMATION:

NOTE: The typical beam angle will be changed by different color, chip size and chip position tolerance. The typical total beam angle is the full angle measured where the luminous intensity is half of the peak value.

MATERIALS:

As part of our continuous research and improvement processes, and to ensure the best possible quality and availability of our products, LEDiL reserves the right to change material grades without notice.

PRODUCT DATA USER AGREEMENT AND DISCLAIMER:

The measured data in the provided downloadable LEDiL Product Datasheets and Mechanical 2D-Drawings is rounded and provided as reference for planning. LEDiL Oy's optical specifications have been verified by conducting performance testing of the products in accordance with the company's quality system. The reported data are averaged results of multiple measurements with typical variation. LEDiL Oy reserves the right to without prior notification make changes and improvements to its products.

LEDiL Oy assumes neither warranty, nor guarantee nor any other liability of any kind for the contents and correctness of the provided data. The provided data has been generated with highest diligence but the provided data may in reality not represent the complete possible variation range of all intrinsic parameters. Therefore, in certain cases a deviation from the provided data could occur.

LEDiL Oy reserves the right to undertake technical changes of its products without further notification which could lead to changes in the provided data. LEDiL Oy assumes no liability of any kind for the possible deviation from any provided data or any other damage resulting from the usage of the provided data.

The user agrees to this disclaimer and user agreement with the download or usage of the provided files.

LEDiL Oy

Joensuunkatu 7
FI-24100 SALO
Finland

LEDiL Inc.

228 West Page Street
Suite D
Sycamore IL 60178
USA

Ledil Optics Technology (Shenzhen) Co., Ltd.

405 , Block B
Casic Motor Building
Shenzhen 518057
P.R.CHINA

Local sales and technical support

[www.ledil.com/
where_to_buy](http://www.ledil.com/where_to_buy)

Shipping locations

Poznan, Poland
Hong Kong, China

Distribution Partners

[www.ledil.com/
where_to_buy](http://www.ledil.com/where_to_buy)