

## FLORENTINA-4X1-RS

~10° spot beam

### SPECIFICATION:

Dimensions	169.7 x 49.7
Height	28.5 mm
Fastening	pin
ROHS compliant	yes ⓘ

### MATERIALS:

Component	Type	Material	Colour	Finish	Length (mm)
ROSE-B-B-RS	Single lens	PC	clear		
FLORENTINA-4X1-HLD	Holder	PC	black		

### ORDERING INFORMATION:

Component		Qty in box	MOQ	MPQ	Box weight (kg)
FCP15344_FLORENTINA-4X1-RS	Single lens	72	72	8	3.4
» Box size: 476 x 273 x 292 mm					



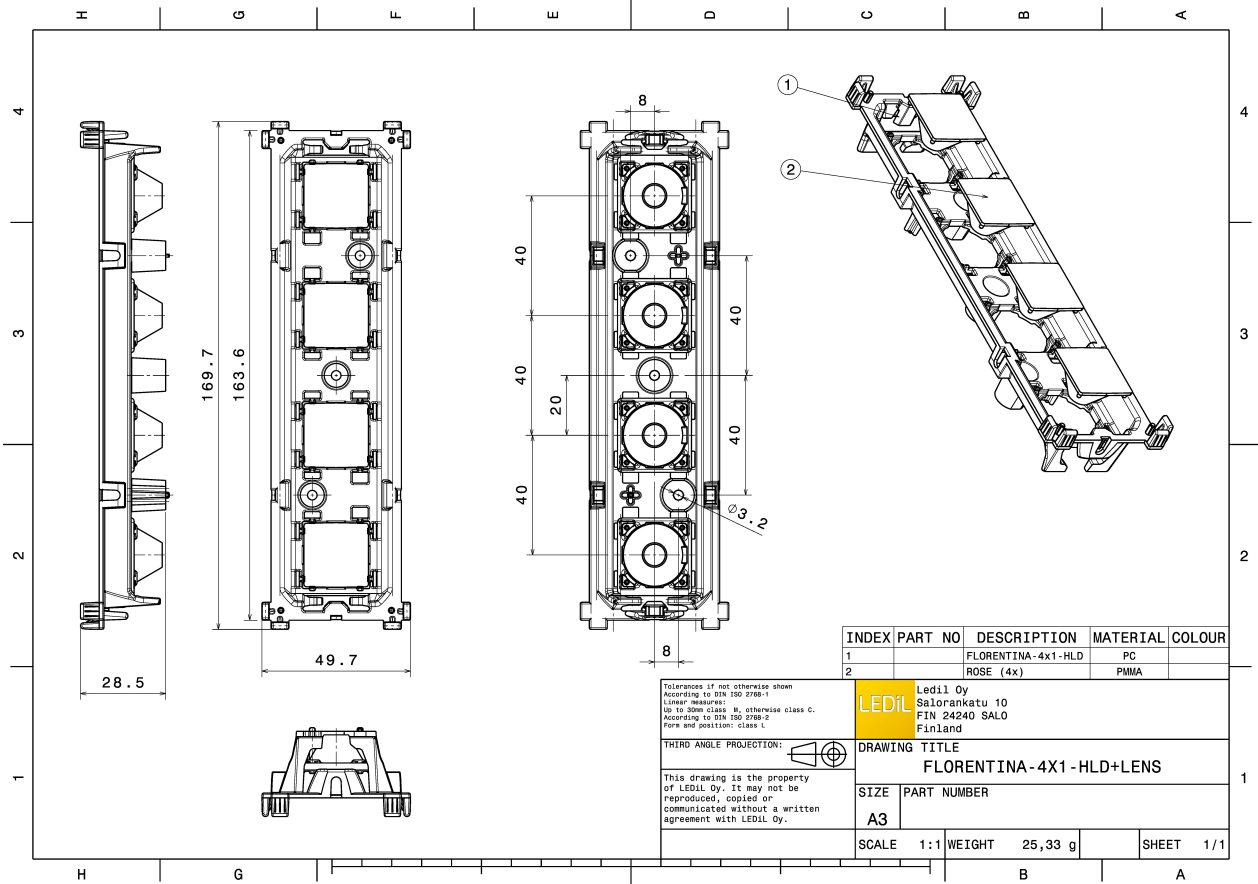

See also our general installation guide: [www.ledil.com/installation\\_guide](http://www.ledil.com/installation_guide)

#### OPTICAL RESULTS (MEASURED):



**LED** EASY-T FLUX 1x4 FLR XG xxx G7  
**FWHM / FWTM** 11.0° / 25.0°  
**Efficiency** 80 %  
**Peak intensity** 12.8 cd/lm  
**LEDs/each optic** 1  
**Light colour/type** White  
**Required components:**  
 C15028\_FLORENTINA-4X1-SHD

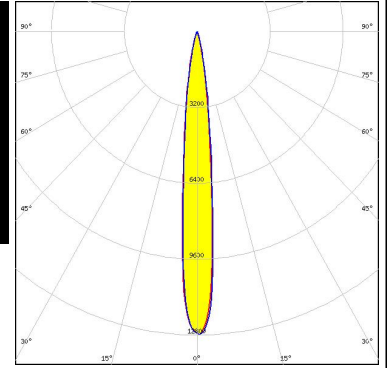

Light distribution files



**LED** EASY-T FLUX 1x4 FLR XT xxx G5  
**FWHM / FWTM** 10.0° / 23.0°  
**Efficiency** 81 %  
**Peak intensity** 15.8 cd/lm  
**LEDs/each optic** 1  
**Light colour/type** White  
**Required components:**  
 C15028\_FLORENTINA-4X1-SHD

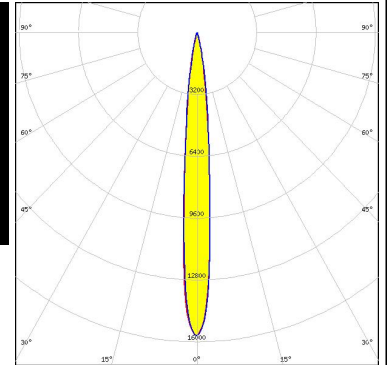
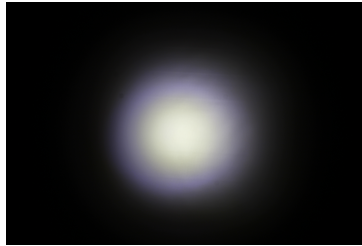

Light distribution files



**LED** XP-G2  
**FWHM / FWTM** 10.0° / 19.0°  
**Efficiency** 82 %  
**Peak intensity** 19 cd/lm  
**LEDs/each optic** 1  
**Light colour/type** White  
**Required components:**  
 C15198\_FLORENTINA-4X1-SHD-OPEN

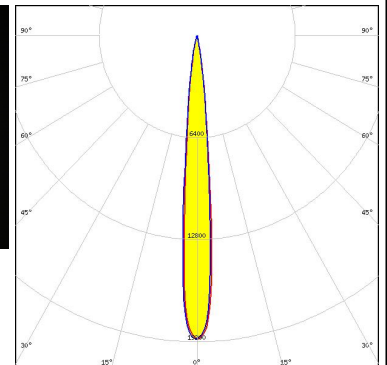
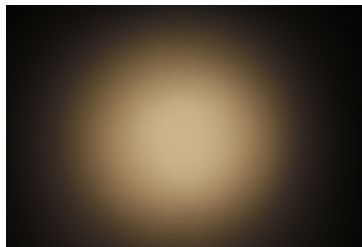

Light distribution files

#### OPTICAL RESULTS (MEASURED):



LED XP-G2  
 FWHM / FWTM 10.0° / 20.0°  
 Efficiency 83 %  
 Peak intensity 19 cd/lm  
 LEDs/each optic 1  
 Light colour/type White  
 Required components:  
 C15690\_FLORENTINA-4X1-SHD-WHT

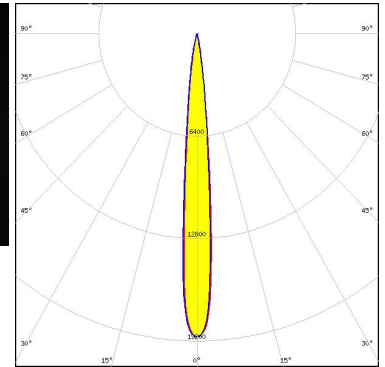
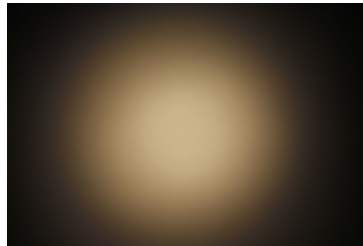

Light distribution files



LED XP-G2  
 FWHM / FWTM 10.0° / 19.0°  
 Efficiency 82 %  
 Peak intensity 19 cd/lm  
 LEDs/each optic 1  
 Light colour/type White  
 Required components:  
 C15028\_FLORENTINA-4X1-SHD

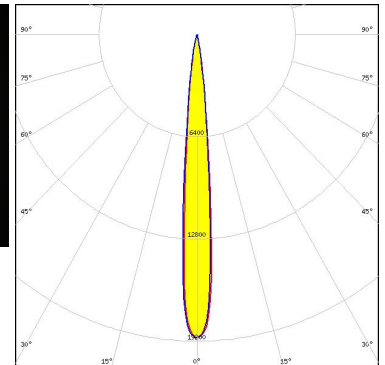
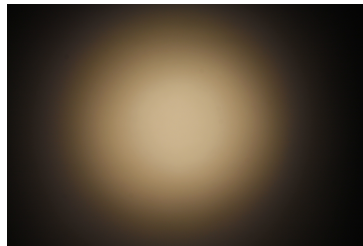

Light distribution files



LED XP-L2  
 FWHM / FWTM 15.0° / 33.0°  
 Efficiency 81 %  
 Peak intensity 6.9 cd/lm  
 LEDs/each optic 1  
 Light colour/type White  
 Required components:  
 C15198\_FLORENTINA-4X1-SHD-OPEN

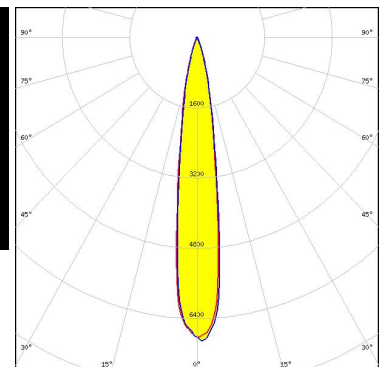
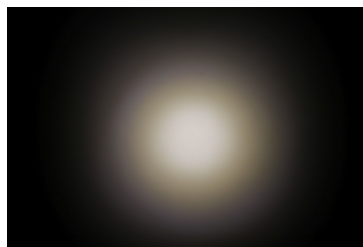

Light distribution files

#### OPTICAL RESULTS (MEASURED):



LED XP-L2  
 FWHM / FWTM 15.0° / 34.0°  
 Efficiency 81 %  
 Peak intensity 6.9 cd/lm  
 LEDs/each optic 1  
 Light colour/type White  
 Required components:  
 C15028\_FLORENTINA-4X1-SHD

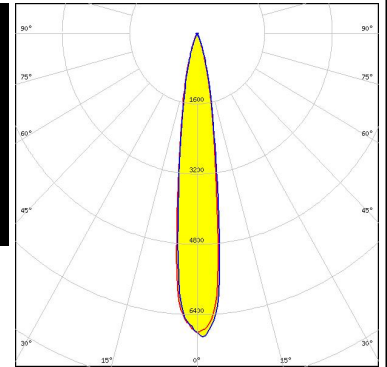

Light distribution files



LED XP-L2  
 FWHM / FWTM 15.0° / 34.0°  
 Efficiency 82 %  
 Peak intensity 6.9 cd/lm  
 LEDs/each optic 1  
 Light colour/type White  
 Required components:  
 C15690\_FLORENTINA-4X1-SHD-WHT

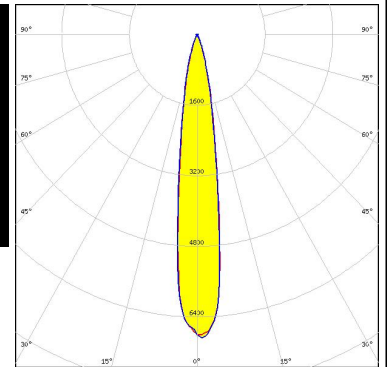
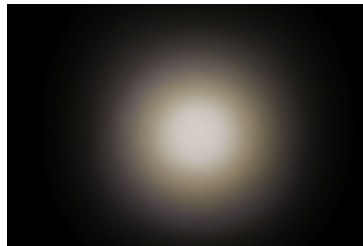

Light distribution files



LED NVSxx19B/NVSxx19C  
 FWHM / FWTM 11.0° / 25.0°  
 Efficiency 85 %  
 Peak intensity 13.5 cd/lm  
 LEDs/each optic 1  
 Light colour/type White  
 Required components:  
 C15028\_FLORENTINA-4X1-SHD

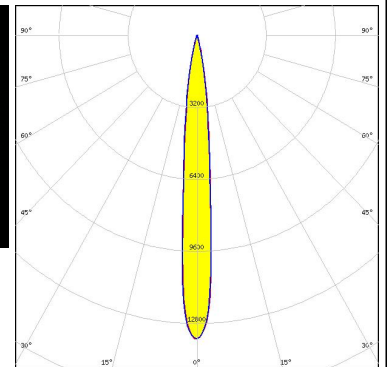

Light distribution files

#### OPTICAL RESULTS (MEASURED):



LED NVSxx19B/NVSxx19C  
 FWHM / FWTM 11.0° / 25.0°  
 Efficiency 85 %  
 Peak intensity 13.5 cd/lm  
 LEDs/each optic 1  
 Light colour/type White  
 Required components:  
 C15198\_FLORENTINA-4X1-SHD-OPEN

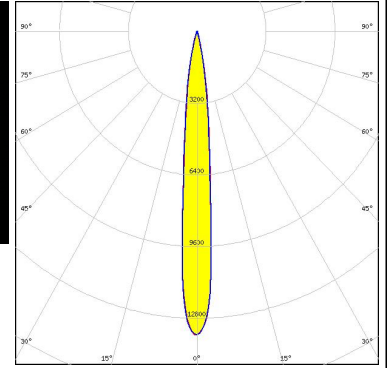

Light distribution files



LED NVSxx19B/NVSxx19C  
 FWHM / FWTM 11.0° / 25.0°  
 Efficiency 86 %  
 Peak intensity 13.5 cd/lm  
 LEDs/each optic 1  
 Light colour/type White  
 Required components:  
 C15690\_FLORENTINA-4X1-SHD-WHT

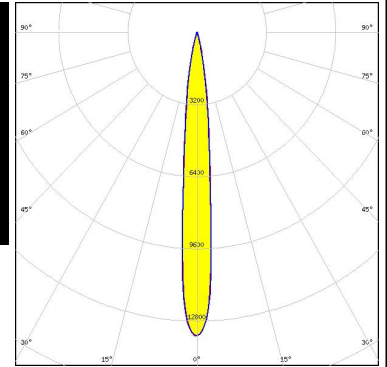
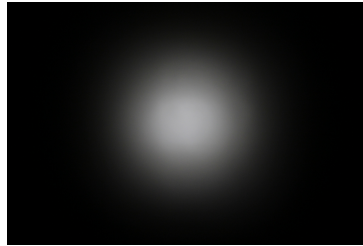

Light distribution files

#### OPTICAL RESULTS (SIMULATED):



LED XP-L HD  
 FWHM / FWTM 16.0° / 28.0°  
 Efficiency 85 %  
 Peak intensity 9.2 cd/lm  
 LEDs/each optic 1  
 Light colour/type White  
 Required components:  
 C15198\_FLORENTINA-4X1-SHD-OPEN

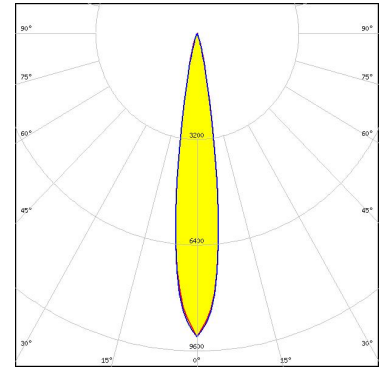

Light distribution files



LED XP-L HD  
 FWHM / FWTM 16.0° / 31.0°  
 Efficiency 77 %  
 Peak intensity 7.4 cd/lm  
 LEDs/each optic 1  
 Light colour/type White  
 Required components:  
 C15028\_FLORENTINA-4X1-SHD

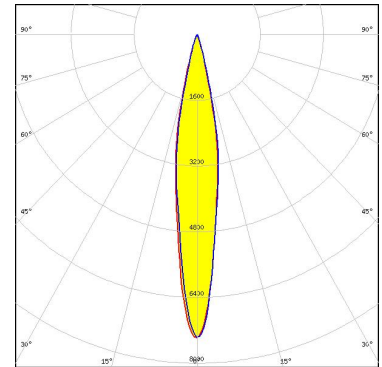

Light distribution files

#### GENERAL INFORMATION:

NOTE: The typical beam angle will be changed by different color, chip size and chip position tolerance. The typical total beam angle is the full angle measured where the luminous intensity is half of the peak value.

#### MATERIALS:

As part of our continuous research and improvement processes, and to ensure the best possible quality and availability of our products, LEDiL reserves the right to change material grades without notice.

#### PRODUCT DATA USER AGREEMENT AND DISCLAIMER:

The measured data in the provided downloadable LEDiL Product Datasheets and Mechanical 2D-Drawings is rounded and provided as reference for planning. LEDiL Oy's optical specifications have been verified by conducting performance testing of the products in accordance with the company's quality system. The reported data are averaged results of multiple measurements with typical variation. LEDiL Oy reserves the right to without prior notification make changes and improvements to its products.

LEDiL Oy assumes neither warranty, nor guarantee nor any other liability of any kind for the contents and correctness of the provided data. The provided data has been generated with highest diligence but the provided data may in reality not represent the complete possible variation range of all intrinsic parameters. Therefore, in certain cases a deviation from the provided data could occur.

LEDiL Oy reserves the right to undertake technical changes of its products without further notification which could lead to changes in the provided data. LEDiL Oy assumes no liability of any kind for the possible deviation from any provided data or any other damage resulting from the usage of the provided data.

The user agrees to this disclaimer and user agreement with the download or usage of the provided files.

#### LEDiL Oy

Joensuunkatu 7  
FI-24100 SALO  
Finland

#### LEDiL Inc.

228 West Page Street  
Suite D  
Sycamore IL 60178  
USA

#### Ledil Optics Technology (Shenzhen) Co., Ltd.

# 405 , Block B  
Casic Motor Building  
Shenzhen 518057  
P.R.CHINA

#### Local sales and technical support

[www.ledil.com/  
where\\_to\\_buy](http://www.ledil.com/where_to_buy)

#### Shipping locations

Poznan, Poland  
Hong Kong, China

#### Distribution Partners

[www.ledil.com/  
where\\_to\\_buy](http://www.ledil.com/where_to_buy)