

TINA-RS

~13° spot beam optimized for LUXEON Rebel.
Assembly with holder, installation tape and
location pins.

SPECIFICATION:

Dimensions	Ø 16.1
Height	9.4 mm
Fastening	tape, pin
ROHS compliant	yes ⓘ



MATERIALS:

Component	Type	Material	Colour	Finish	Length (mm)
TINA-XP-RS	Single lens	PMMA	clear		
TINA-H-TAPE-RE-BLK	Holder	PC	black		
TINA-TAPE3	Tape	Acryl tape	black		

ORDERING INFORMATION:

Component	Qty in box	MOQ	MPQ	Box weight (kg)
FA11212_TINA-RS » Box size: 470 x 240 x 105 mm	2016	288	144	4.1

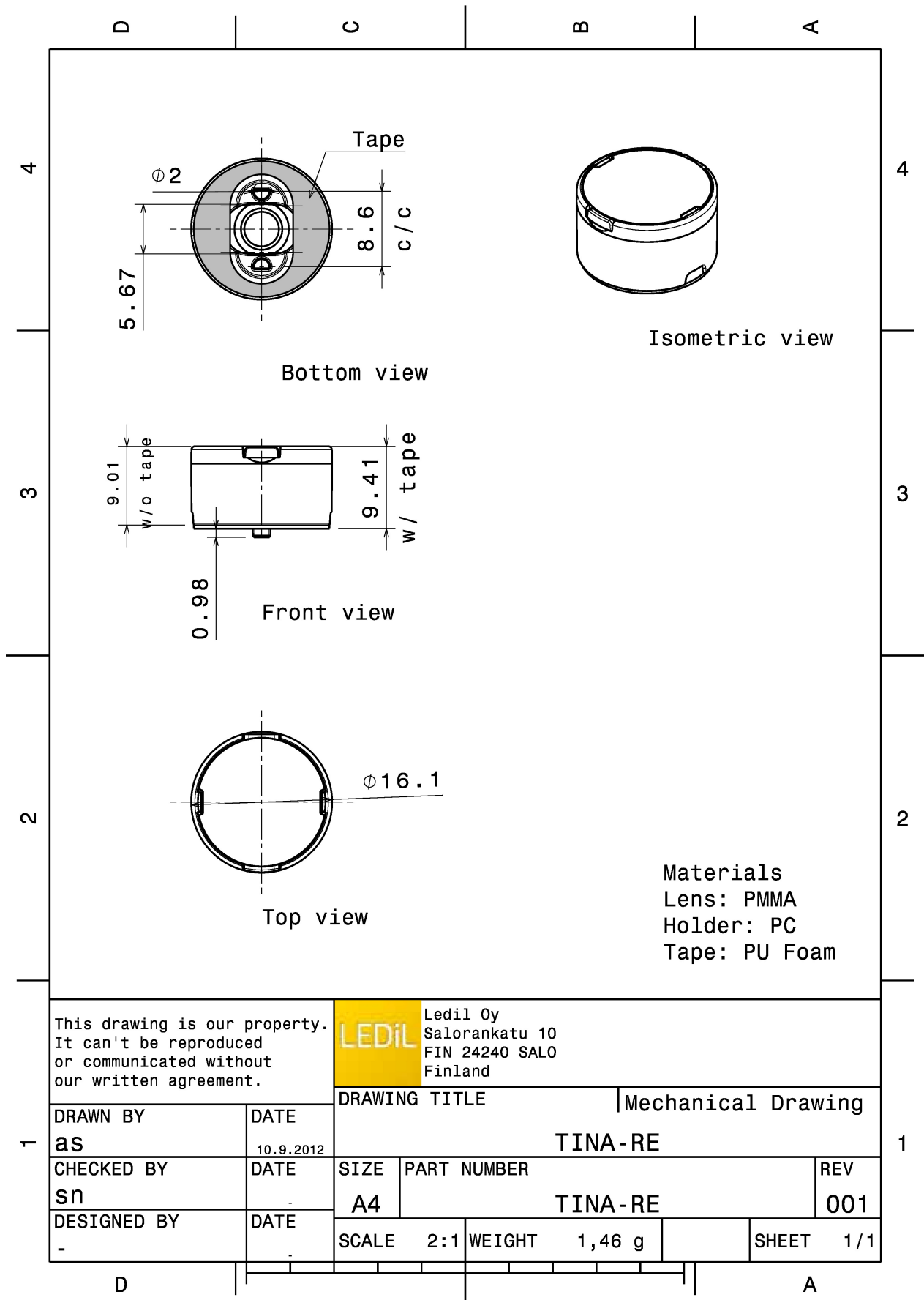

This drawing is our property. It can't be reproduced or communicated without our written agreement.		LEDiL LediL Oy Salorankatu 10 FIN 24240 SALO Finland	
DRAWN BY as		DATE 10.9.2012	
CHECKED BY sn		DATE -	
DESIGNED BY -		DATE -	
DRAWING TITLE TINA-RE		Mechanical Drawing	
SIZE A4	PART NUMBER TINA-RE	REV 001	
SCALE 2:1	WEIGHT 1,46 g	SHEET 1/1	

See also our general installation guide: www.ledil.com/installation_guide

OPTICAL RESULTS (MEASURED):



LED XB-H
FWHM / FWTM 15.0° / 26.0°
Efficiency 88 %
Peak intensity 10.3 cd/lm
LEDs/each optic 1
Light colour/type White
Required components:

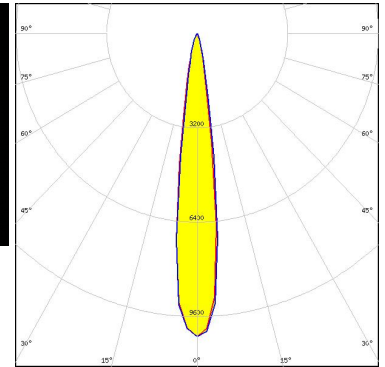
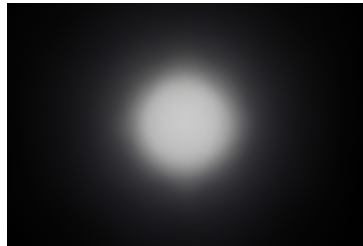

Light distribution files



LED LUXEON Rebel
FWHM / FWTM 10.0° / 20.0°
Efficiency 93 %
Peak intensity 16.9 cd/lm
LEDs/each optic 1
Light colour/type White
Required components:

Light distribution files



LED LUXEON TX
FWHM / FWTM 15.0° / 28.0°
Efficiency 88 %
Peak intensity 10.5 cd/lm
LEDs/each optic 1
Light colour/type White
Required components:

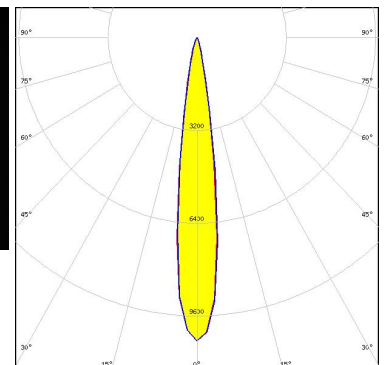
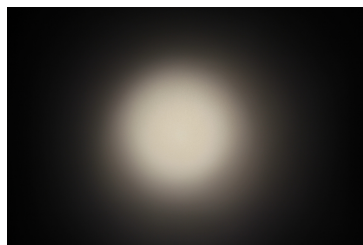

Light distribution files

OPTICAL RESULTS (MEASURED):



LED LUXEON Z ES
FWHM / FWTM 12.0° / 20.0°
Efficiency 89 %
Peak intensity 19.8 cd/lm
LEDs/each optic 1
Light colour/type White
Required components:

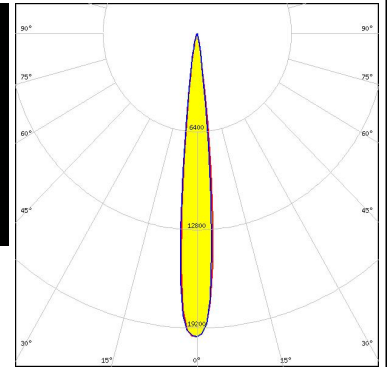

Light distribution files

OPTICAL RESULTS (SIMULATED):



LED XB-D
 FWHM / FWTM 18.0° / 34.0°
 Efficiency 89 %
 Peak intensity 7.7 cd/lm
 LEDs/each optic 1
 Light colour/type White
 Required components:

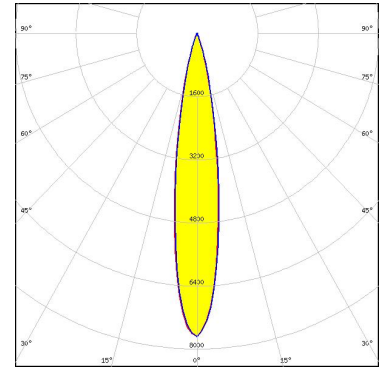

Light distribution files



LED LUXEON CZ
 FWHM / FWTM 16.0° / 30.0°
 Efficiency 92 %
 Peak intensity 10.3 cd/lm
 LEDs/each optic 1
 Light colour/type Red
 Required components:

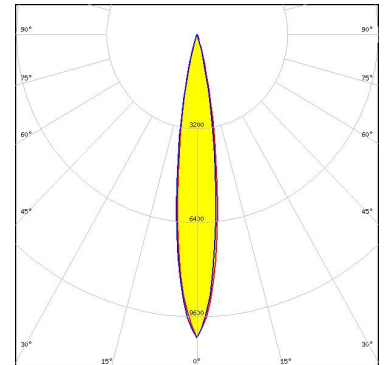

Light distribution files



LED LUXEON H50-2
 FWHM / FWTM 16.0° / 31.0°
 Efficiency 92 %
 Peak intensity 8.5 cd/lm
 LEDs/each optic 1
 Light colour/type White
 Required components:

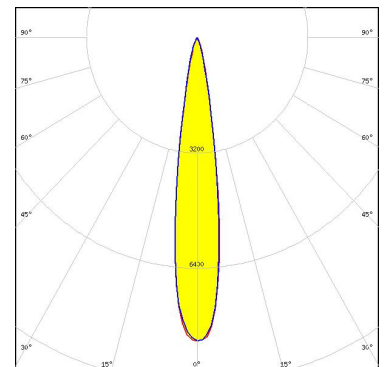

Light distribution files

OPTICAL RESULTS (SIMULATED):



LED LUXEON HL1Z
 FWHM / FWTM 10.0° / 20.0°
 Efficiency 90 %
 Peak intensity 22.1 cd/lm
 LEDs/each optic 1
 Light colour/type White
 Required components:

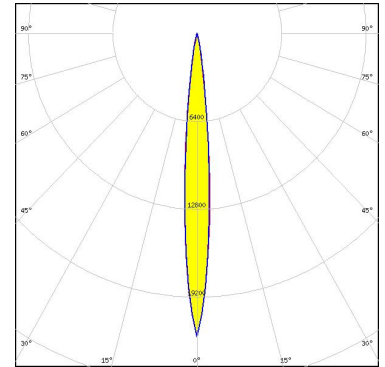

Light distribution files



LED LUXEON HL2Z
 FWHM / FWTM 16.0° / 33.0°
 Efficiency 91 %
 Peak intensity 8.1 cd/lm
 LEDs/each optic 1
 Light colour/type White
 Required components:

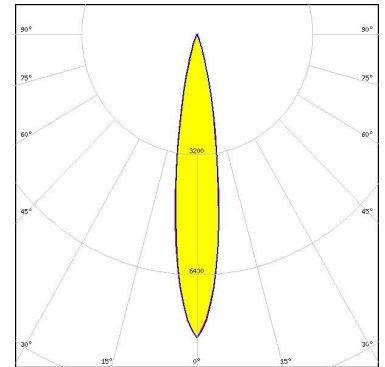

Light distribution files



LED LUXEON T
 FWHM / FWTM 16.0° / 30.0°
 Efficiency 92 %
 Peak intensity 8.8 cd/lm
 LEDs/each optic 1
 Light colour/type White
 Required components:

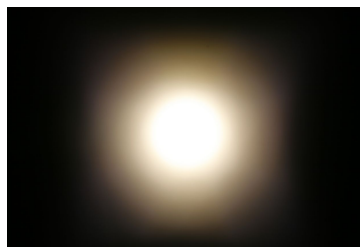

Light distribution files

GENERAL INFORMATION:

NOTE: The typical beam angle will be changed by different color, chip size and chip position tolerance. The typical total beam angle is the full angle measured where the luminous intensity is half of the peak value.

MATERIALS:

As part of our continuous research and improvement processes, and to ensure the best possible quality and availability of our products, LEDiL reserves the right to change material grades without notice.

PRODUCT DATA USER AGREEMENT AND DISCLAIMER:

The measured data in the provided downloadable LEDiL Product Datasheets and Mechanical 2D-Drawings is rounded and provided as reference for planning. LEDiL Oy's optical specifications have been verified by conducting performance testing of the products in accordance with the company's quality system. The reported data are averaged results of multiple measurements with typical variation. LEDiL Oy reserves the right to without prior notification make changes and improvements to its products.

LEDiL Oy assumes neither warranty, nor guarantee nor any other liability of any kind for the contents and correctness of the provided data. The provided data has been generated with highest diligence but the provided data may in reality not represent the complete possible variation range of all intrinsic parameters. Therefore, in certain cases a deviation from the provided data could occur.

LEDiL Oy reserves the right to undertake technical changes of its products without further notification which could lead to changes in the provided data. LEDiL Oy assumes no liability of any kind for the possible deviation from any provided data or any other damage resulting from the usage of the provided data.

The user agrees to this disclaimer and user agreement with the download or usage of the provided files.

LEDiL Oy

Joensuunkatu 7
FI-24100 SALO
Finland

LEDiL Inc.

228 West Page Street
Suite D
Sycamore IL 60178
USA

Ledil Optics Technology (Shenzhen) Co., Ltd.

405 , Block B
Casic Motor Building
Shenzhen 518057
P.R.CHINA

Local sales and technical support

[www.ledil.com/
where_to_buy](http://www.ledil.com/where_to_buy)

Shipping locations

Poznan, Poland
Hong Kong, China

Distribution Partners

[www.ledil.com/
where_to_buy](http://www.ledil.com/where_to_buy)