

Features

- 4-Bit, 2 dB LSB, 30 dB Range
- Insertion Loss:
 - 2.0 dB @ 26.5 GHz
 - 3.1 dB @ 50 GHz
- P0.1 dB: 26dBm @ 40 GHz
- Integrated CMOS Compatible Driver
- Compatible with 1.8 V, 2.5 V, and 3.3 V CMOS Logic
- Parallel or Serial (P/S) Control
- Low DC Power Consumption
- Lead-Free 3 mm 20-Lead Package
- Halogen-Free “Green” Mold Compound
- RoHS* Compliant

Applications

- ISM, Test and Measurement
- Multi Market

Description

The MAAD-011049 is a wide band 4-bit, 2 dB step MMIC digital attenuator in a lead-free 3 mm, 20 lead surface mount laminate package. This device is ideally suited for use where high accuracy, very low power consumption, and low intermodulation products are required.

This attenuator is controlled with either a SPI compatible serial interface or a 4 bit parallel word. SEROUT is the SERIN delayed by 6 clock cycles which can be used in daisy-chain operation.

Ordering Information^{1,2}

Part Number	Package
MAAD-011049-TR0500	500 piece reel
MAAD-011049-SB1	Sample Board

1. Reference Application Note M513 for reel size information.
2. All sample boards include 3 loose parts.

Functional Schematic

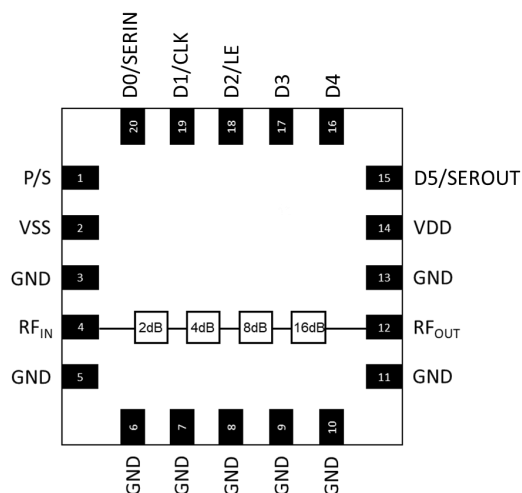

Pin Names³

Pin #	Function
1	Parallel/Serial Selection
2	Negative Supply
3, 5 - 11, 13	Ground
4	RF Input
12	RF Output
14	Positive Supply
15	16 dB bit or Serial Output
16	8 dB Bit Control
17	4 dB Bit Control
18	2 dB Bit or LE
19	Clock
20	Serial Input
21	Ground Paddle ⁴

3. MACOM recommends connecting unused package pins to ground.
4. The exposed pad centered on the package bottom must be connected to RF, DC and thermal ground.

* Restrictions on Hazardous Substances, compliant to current RoHS EU directive.

Pin Description

Pin #	Name	Description
1	P/S	Selection of serial or parallel control mode
2	VSS	Negative supply Input
3, 5 - 11, 13	GND	Ground. The GND pins must be connected to the RF and DC ground of the PCB
4	RF _{IN}	Attenuator Input. The RF _{IN} pin is DC-coupled to 0 V and AC matched to 50 Ω. No DC blocking
12	RF _{OUT}	Attenuator Output. The RF _{OUT} pin is DC-coupled to 0 V and AC matched to 50 Ω. No DC blocking
14	VDD	Positive supply Input
15	D5/SEROUT	Parallel control input for 16 dB attenuation bit or serial input control delayed by 6 clock cycles
16	D4	Parallel control input for 8 dB attenuation bit
17	D3	Parallel control input for 4 dB attenuation bit
18	D2/LE	Parallel control input for 2 dB attenuation bit or latch enable input of serial control mode
19	D1/CLK	Clock input of serial control mode
20	D0/SERIN	Control word input of serial control mode
21	Pad	Exposed Pad. The exposed pad must be connected to the RF and DC ground of the PCB

Digital Attenuator, 2 dB LSB, 4-Bit

30 dB, DC - 55 GHz



MAAD-011049

Rev. V5

AC Electrical Specifications:

$T_A = 25^\circ\text{C}$, $V_{DD} = +3.3\text{ V}$, $V_{SS} = -3.3\text{ V}$, $P_{IN} = 0\text{ dBm}$, $Z_0 = 50\ \Omega$

Parameter	Test Conditions	Units	Min.	Typ.	Max.
Reference Insertion Loss	DC - 18.0 GHz	dB	—	1.5	2.6
	18.0 - 26.5 GHz			2.0	3.2
	26.5 - 40.0 GHz			2.3	3.8
	40.0 - 50.0 GHz			3.1	—
	50.0 - 55.0 GHz			3.0	—
RMS Attenuation Error	DC - 18.0 GHz	dB	—	0.4	—
	18.0 - 26.5 GHz			0.7	
	26.5 - 40.0 GHz			0.9	
	40.0 - 55.0 GHz			0.7	
Attenuation Accuracy	DC - 18.0 GHz			± (0.3 + 2% of attenuation setting) dB typ.	
	18.0 - 26.5 GHz			± (0.3 + 3% of attenuation setting) dB typ.	
	26.5 - 40.0 GHz			± (0.3 + 5% of attenuation setting) dB typ.	
	40.0 - 55.0 GHz			± (0.3 + 5% of attenuation setting) dB typ.	
Input Return Loss	All states	dB	—	-15	—
Output Return Loss	All states	dB	—	-12	—
Input P0.1dB	10 GHz @ Reference State	dBm	—	27	—
IIP ₃ @ 10 GHz	2-Tone, +7 dBm/tone, 1 MHz Spacing (Reference State)	dBm	—	50	—
T _{RISE} , T _{FALL}	10% to 90% RF, 90% to 10% RF	ns	—	15	—
T _{ON} , T _{OFF}	50% triggered control to 90%, 10% of RF	ns	—	125	—
Overshoot	All state changes	dB	—	2.8	—
Undershoot	All state changes	dB	—	-10	—

5. Apply VDD and VSS before RF signal. No sequence requirement for VDD & VSS.

DC Electrical Specifications: $T_A = 25^\circ\text{C}$, $V_{DD} = +3.3\text{ V}$, $V_{SS} = -3.3\text{ V}$

Parameter	Test Conditions	Units	Min.	Typ.	Max.
I _{DD} Quiescent Current	—	mA	—	0.3	—
I _{SS} Quiescent Current	—	mA	—	0.6	—
Logic Input High V _{IH}	—	V	1.17	—	3.3
Logic Input Low V _{IL}	—	V	0	—	0.8
Logic Input Current	V _{IH} = 1.8 V	μA	—	—	10
SEROUT Output High V _{OH}	18 KΩ load	V	—	1.8	—
SEROUT Output Low V _{OL}	18 KΩ load	V	—	0	—

Recommended Operating Conditions

Parameter	Symbol	Unit	Min.	Typ.	Max.
Input Power, 100 MHz to 40 GHz (RF _{IN} and RF _{OUT}) ⁶	-	dBm	—	—	26
Positive Supply Voltage	VDD	V	+3.15	+3.3	+3.45
Negative Supply Voltage	VSS	V	-3.45	-3.3	-3.15
Operating Temperature ⁷	T _c	°C	-40	25	105

Absolute Maximum Ratings^{8,9}

Parameter	Symbol	Unit	Min.	Max.
Input Power, 100 MHz to 40 GHz (RF _{IN} and RF _{OUT}) ⁶	-	dBm	—	27
Positive Supply Voltage	VDD	V	-0.3	3.6
Negative Supply Voltage	VSS	V	-3.6	+0.3
Logic Input Voltage	V _I	V	-0.2	+3.6
Operating Temperature ⁷	T _c	°C	-40	105
Storage Temperature	-	°C	-65	150

6. T_{PADDLE} = +105°C. See power derating curve for details.

7. Temperature of the exposed pad.

8. Exceeding any one or combination of these limits may cause permanent damage to this device.

9. MACOM does not recommend sustained operation near these survivability limits.

Power Derating Curve

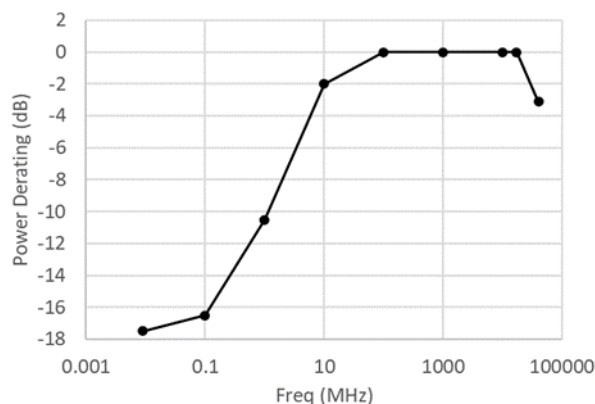

Handling Procedures

Please observe the following precautions to avoid damage:

Static Sensitivity

These electronic devices are sensitive to electrostatic discharge (ESD) and can be damaged by static electricity. Proper ESD control techniques should be used when handling these devices.

Parameter	Rating	Standard
Human Body Model (HBM)	Class 1B	ESDA/JEDEC JS-001
Charged Device Model (CDM)	Class C3	ESDA/JEDEC JS-002

Modes of Operation: Serial and Direct Parallel

Serial Mode

The serial control interface (SERIN, CLK, LE, SEROUT) is compatible with the SPI protocol. SPI mode is activated when P/S is kept high. The 6-bit serial word must be loaded with the MSB first. After shifting in the 6 bit word, a rising edge on LE will set the attenuator to the desired state. While LE is high the CLK is masked to protect the data while implementing the change. SEROUT is SERIN delayed by 6 clock cycles.

When P/S is low, the serial control interface is disabled. When P/S is set high, pins 18, 19, & 20 have the LE, CLK, and SER IN functions, respectively.

In serial mode operation, the outputs will stay constant while LE is kept low.

Direct Parallel Mode

The parallel mode is enabled when P/S is set low. In the direct parallel mode, the phase shifter is controlled by the parallel control inputs directly. When P/S is set low, pin 18 has the D2 functions.

Mode Truth Table

P/S	LE	Mode
1	X	Serial
0	N/A	Direct Parallel

Truth Table¹⁰

D5	D4	D3	D2	D1	D0	Attenuation (dB)
0	0	0	0	X	X	Reference IL
0	0	0	1	X	X	2
0	0	1	0	X	X	4
0	1	0	0	X	X	8
1	0	0	0	X	X	16
1	1	1	1	X	X	30

¹⁰."0" = V_{IL}, "1" = V_{IH}.

Functionality Modes of Operation: Serial and Direct Parallel

Serial Input Interface Timing Diagram

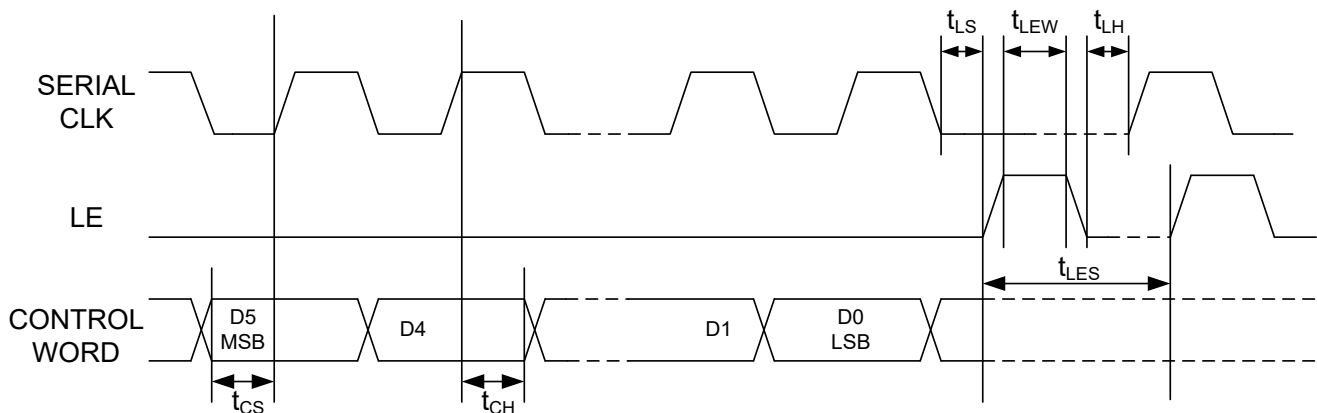

Serial Interface Timing Characteristics

Symbol	Parameter	Typical Performance			Units
		-40°C	+25°C	+85°C	
t_{SCK}	Min. Serial Clock Period	100	100	100	ns
t_{CS}	Min. Control Set-up Time	20	20	20	ns
t_{CH}	Min. Control Hold Time	20	20	20	ns
t_{LS}	Min. LE Set-up Time	10	10	10	ns
t_{LEW}	Min. LE Pulse Width	10	10	10	ns
t_{LH}	Min. Serial Clock Hold Time from LE	10	10	10	ns
t_{LES}	Min. LE Pulse Spacing	630	630	630	ns

Digital Attenuator, 2 dB LSB, 4-Bit 30 dB, DC - 55 GHz



MAAD-011049

Rev. V5

PCB Layout

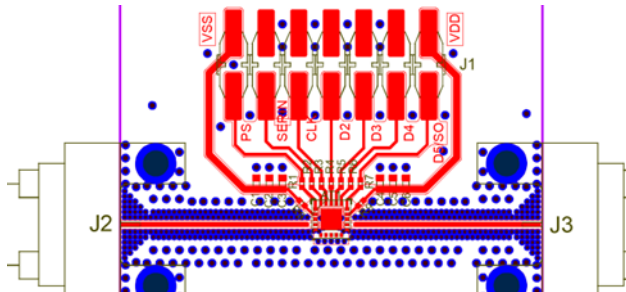

Parts List

Part	Value	Case Style
AT1	MAAD-011049	3 mm, 20 Lead
C1, C6	Capacitor, 1 μ F, 50 V	0402
C2, C5	Capacitor, 10 nF, 50 V	0402
C3, C4	Capacitor, 100 pF, 50 V	0402
R1 - R9	Resistor, 0 Ω	0201
J2 - J3	Southwest 1492-03A-5	End Launch 2.4 mm Female
J1	DC Connector	TSM-107-01-S-DV

Application Schematic

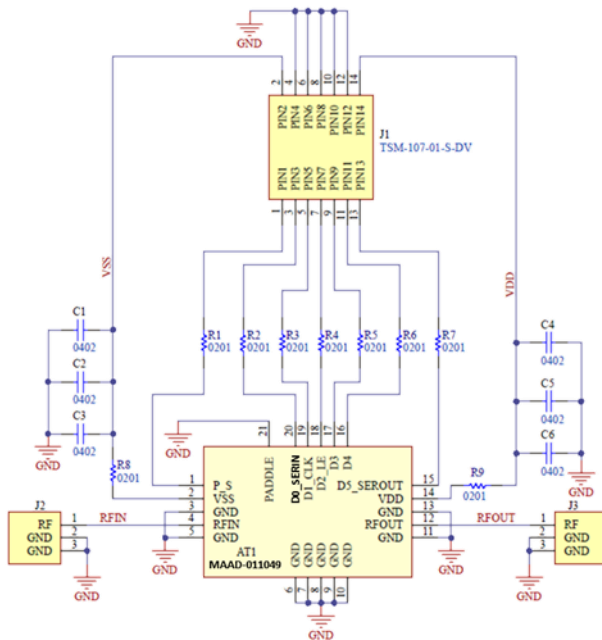

Typical Performance Curves

Insertion Loss

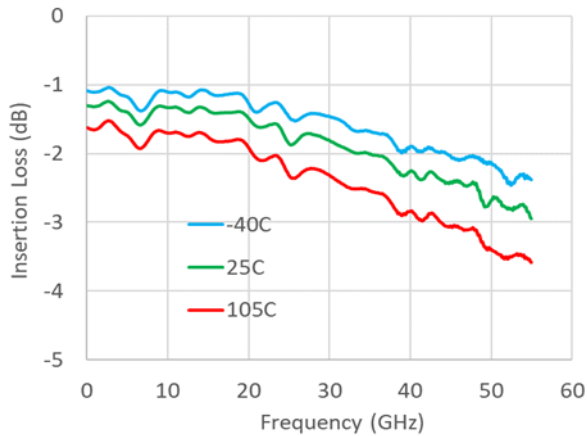

Input Return Loss - Reference State

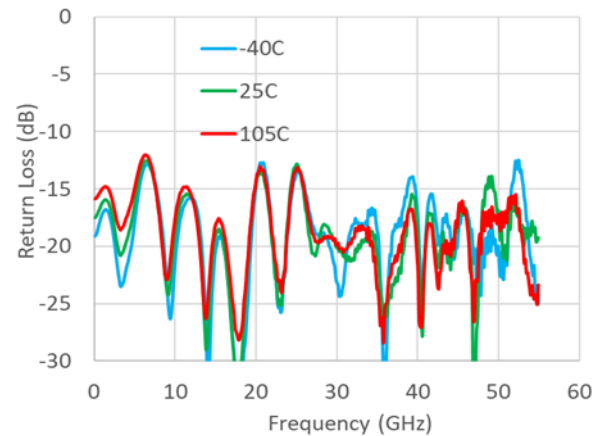

Output Return Loss - Reference State

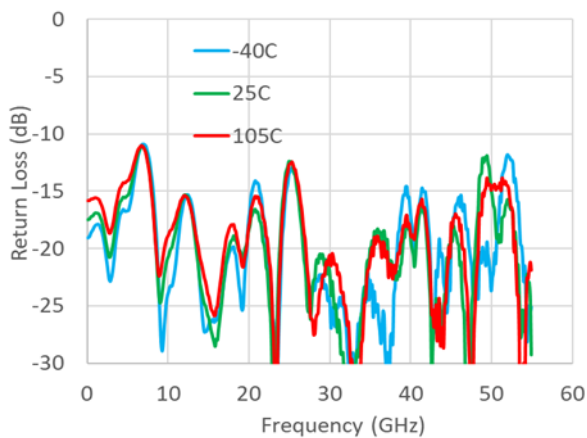

Attenuation - Major Bits

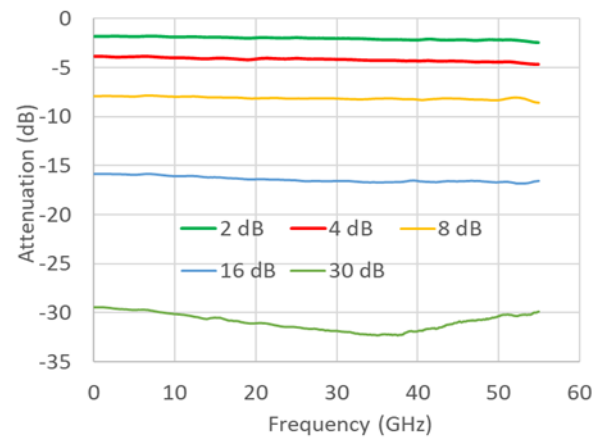

Input Return Loss - Major Bits

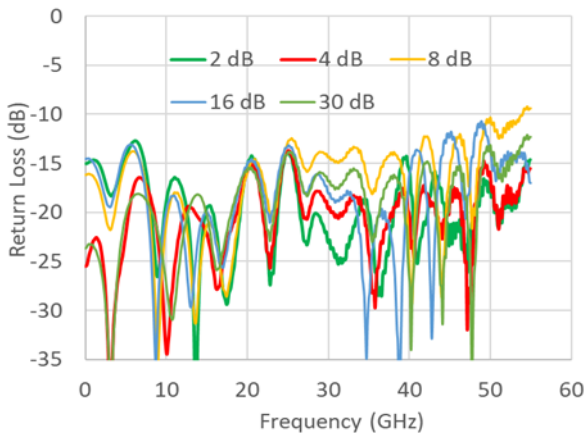

Output Return Loss - Major Bits

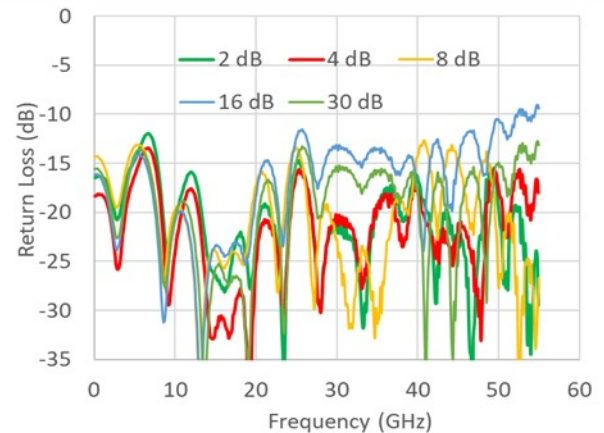

Typical Performance Curves

Attenuation Error - Major Bits

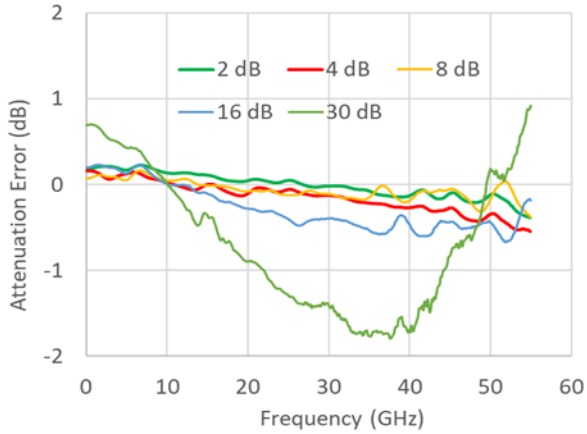

Relative Phase - Major Bits

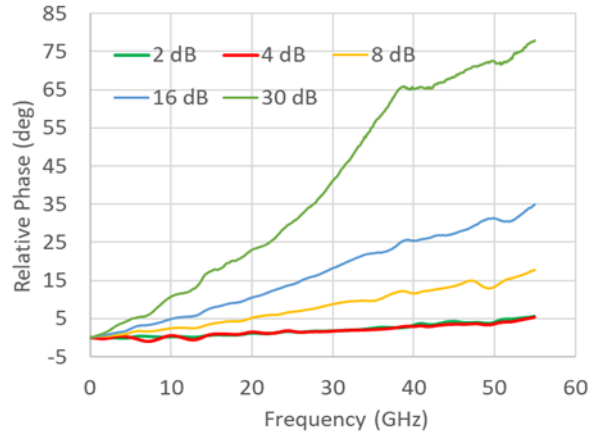

RMS Attenuation Error

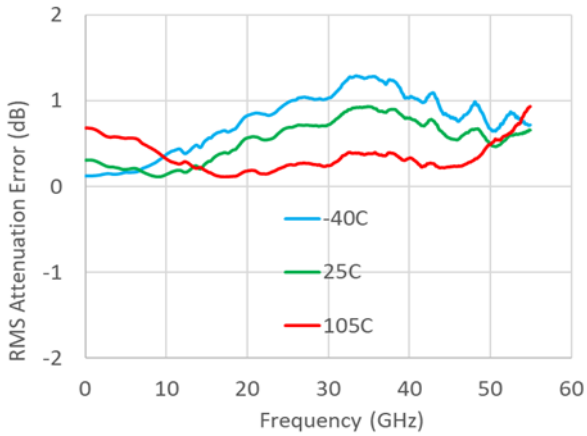

Ref. State Insertion Loss Compression - 100 MHz

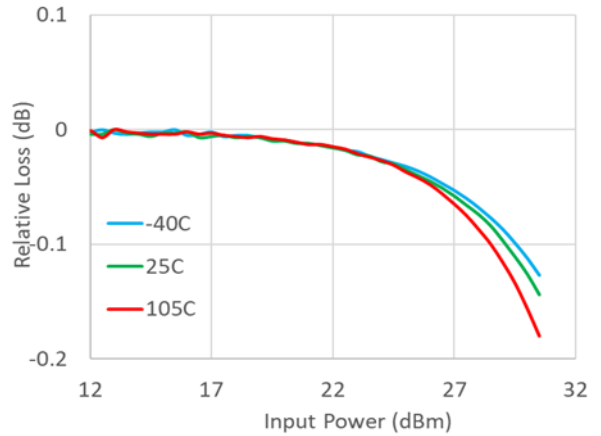

Ref. State Insertion Loss Compression - 10 GHz

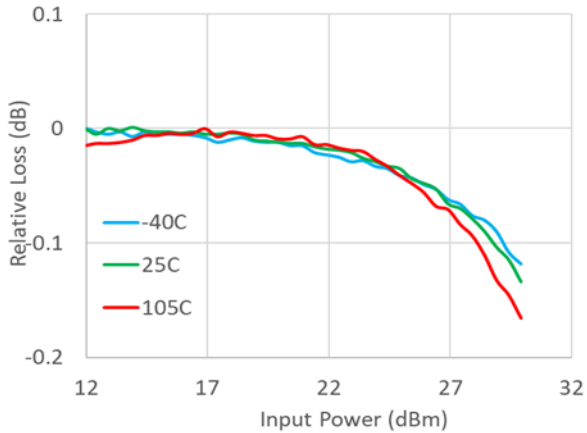

Ref. State Insertion Loss Compression - 40 GHz

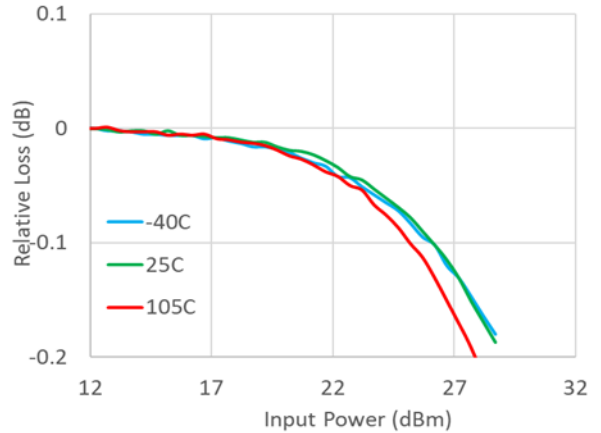

Typical Performance Curves

Evaluation Board Thru Line Insertion Loss

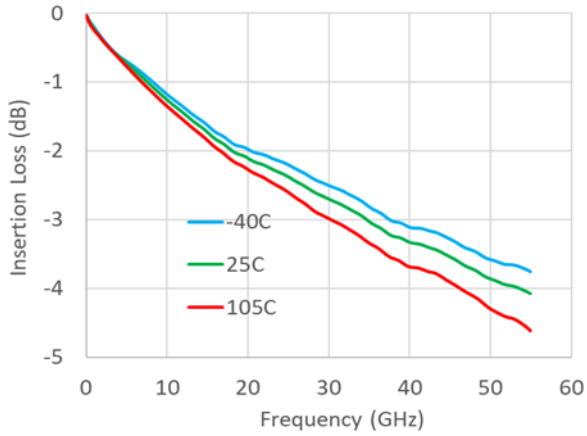

Lead-Free 3 mm, 20-Lead Laminate Package[†]

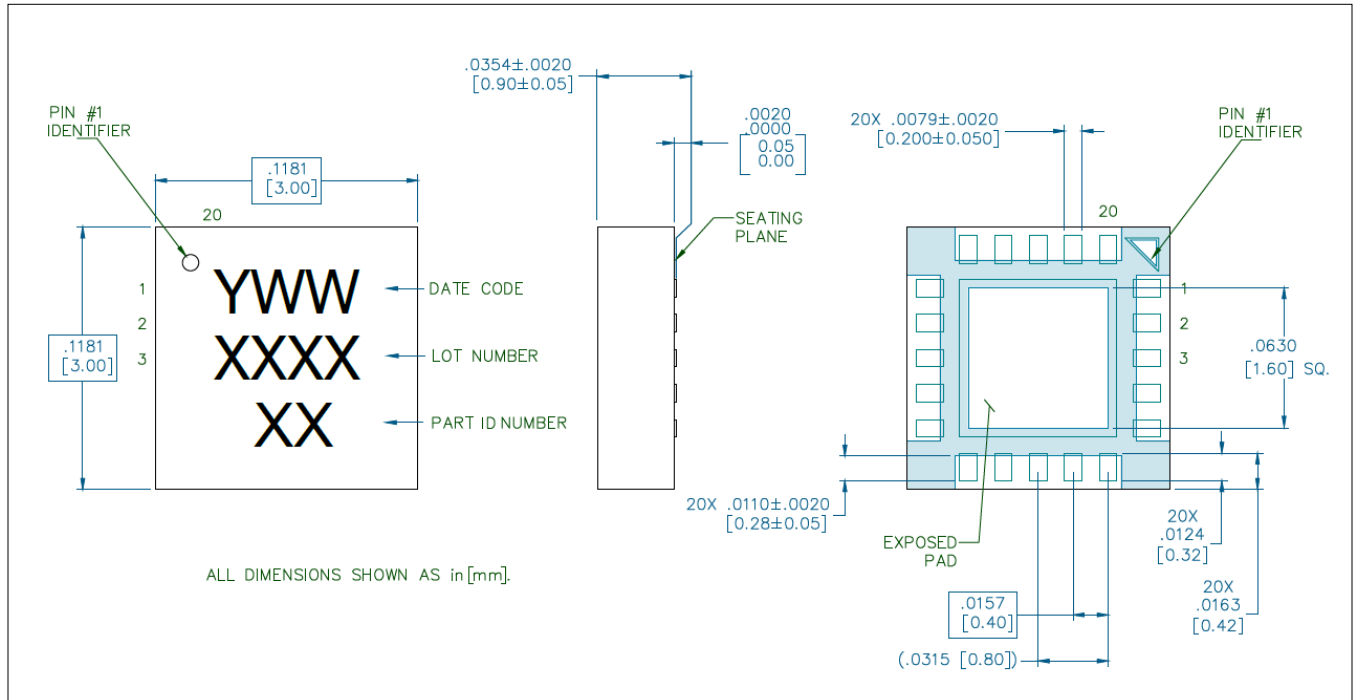

[†] Reference Application Note S2083 for lead-free solder reflow recommendations.
Meets JEDEC moisture sensitivity level 3 requirements in accordance to JEDEC J-STD-020D.
Plating is 100% NiPdAg over copper.

MACOM Technology Solutions Inc. ("MACOM"). All rights reserved.

These materials are provided in connection with MACOM's products as a service to its customers and may be used for informational purposes only. Except as provided in its Terms and Conditions of Sale or any separate agreement, MACOM assumes no liability or responsibility whatsoever, including for (i) errors or omissions in these materials; (ii) failure to update these materials; or (iii) conflicts or incompatibilities arising from future changes to specifications and product descriptions, which MACOM may make at any time, without notice. These materials grant no license, express or implied, to any intellectual property rights.

THESE MATERIALS ARE PROVIDED "AS IS" WITH NO WARRANTY OR LIABILITY, EXPRESS OR IMPLIED, RELATING TO SALE AND/OR USE OF MACOM PRODUCTS INCLUDING FITNESS FOR A PARTICULAR PURPOSE, MERCHANTABILITY, INFRINGEMENT OF INTELLECTUAL PROPERTY RIGHT, ACCURACY OR COMPLETENESS, OR SPECIAL, INDIRECT, INCIDENTAL, OR CONSEQUENTIAL DAMAGES WHICH MAY RESULT FROM USE OF THESE MATERIALS.

MACOM products are not intended for use in medical, lifesaving or life sustaining applications. MACOM customers using or selling MACOM products for use in such applications do so at their own risk and agree to fully indemnify MACOM for any damages resulting from such improper use or sale.