

ANT-916-PML-ccc

Data Sheet

Product Description

Designed for permanent attachment, the PML ½-wave whip tilts 180 degrees and delivers outstanding performance in a cost-effective package. An internal counterpoise eliminates external ground plane dependence and maximizes performance. The antenna is attached by placing its base through a ¼" (6.35 mm) hole in the product and securing it with a nut or by threading it into a PEM-style insert. This method of attachment is highly secure and saves the cost of an antenna connector. The PML attaches to a PCB or connector via 12" (30.48 cm) of RG-178 coax cable. It is also available with 1.32 mm coax cable terminated with a U.FL/MHF compatible connector. This saves the labor of adding a connector while using one that is small enough to fit through the antenna's mounting hole. Custom lengths and terminations are available by special order.

Features

- Cost-effective
- Internal counterpoise
- Tilts 180 degrees
- Outstanding performance
- Omni-directional pattern
- Low VSWR
- Integral 12" (30.48 cm) RG-178 coax cable or 1.32 mm coax (U.FL)

Electrical Specifications

Center Frequency:	916MHz
Recom. Freq. Range:	881-951MHz
Bandwidth:	70MHz
Wavelength:	½-wave
VSWR:	≤ 1.9 typical
Peak Gain:	-0.4dBi max
Impedance:	50-ohms
Cable:	12" (30.48 cm) RG-178 or 1.32 mm coax (U.FL)
Connection:	Straight-cut or U.FL/MHF
Oper. Temp. Range:	-40°C to +90°C

Electrical specifications and plots measured on 10.16 cm x 10.16 cm (4.00" x 4.00") reference ground plane

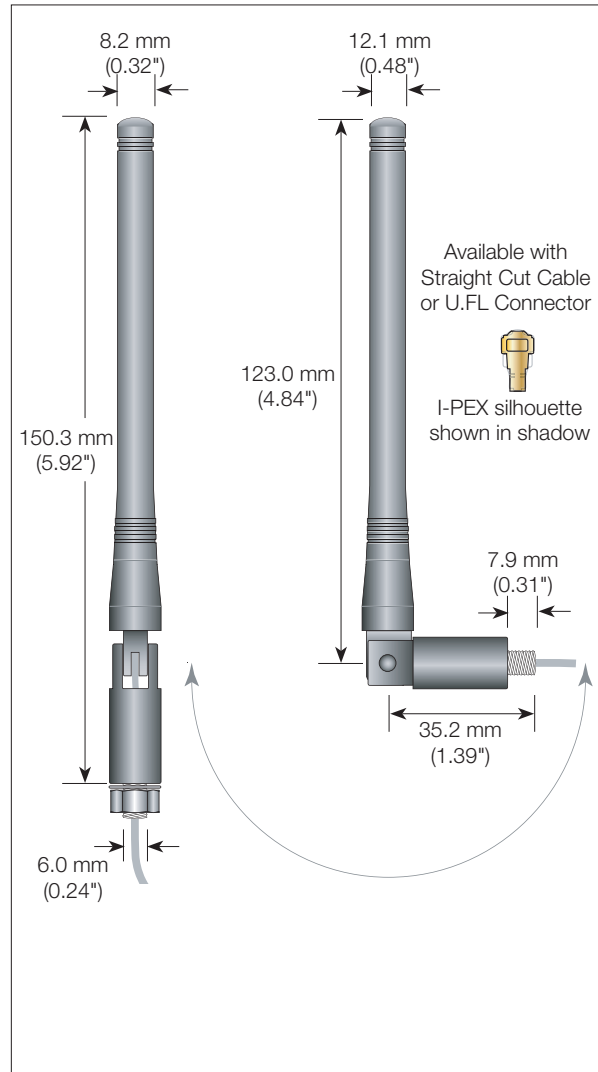

Ordering Information

ANT-916-PML (with straight cut RG-178 coax)
ANT-916-PML-UFL (with U.FL/MHF compatible connector and 1.32mm coax)

VSWR Graph

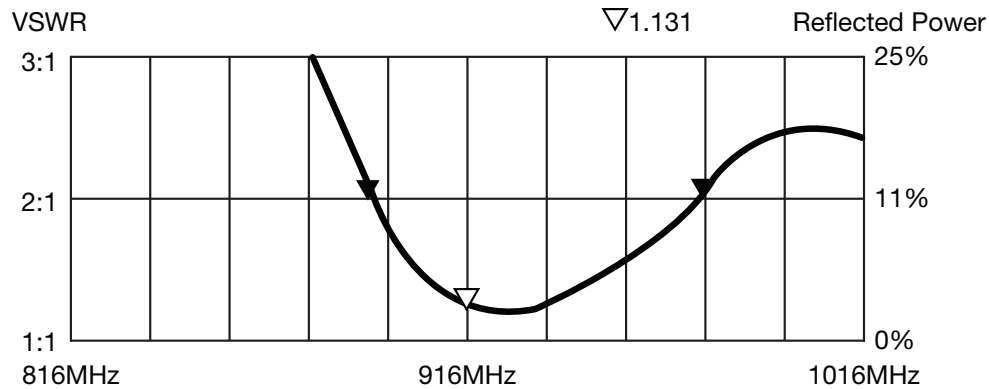

What is VSWR?

The Voltage Standing Wave Ratio (VSWR) is a measurement of how well an antenna is matched to a source impedance, typically 50-ohms. It is calculated by measuring the voltage wave that is headed toward the load versus the voltage wave that is reflected back from the load. A perfect match has a VSWR of 1:1. The higher the first number, the worse the match, and the more inefficient the system. Since a perfect match cannot ever be obtained, some benchmark for performance needs to be set. In the case of antenna VSWR, this is usually 2:1. At this point, 88.9% of the energy sent to the antenna by the transmitter is radiated into free space and 11.1% is either reflected back into the source or lost as heat on the structure of the antenna. In the other direction, 88.9% of the energy recovered by the antenna is transferred into the receiver. As a side note, since the “:1” is always implied, many data sheets will remove it and just display the first number.

How to Read a VSWR Graph

VSWR is usually displayed graphically versus frequency. The lowest point on the graph is the antenna’s operational center frequency. In most cases, this is different than the designed center frequency due to fabrication tolerances. The VSWR at that point denotes how close to 50-ohms the antenna gets. Linx specifies the recommended bandwidth as the range where the typical antenna VSWR is less than 2:1.

TE TECHNICAL SUPPORT CENTER

USA:	+1 (800) 522-6752
Canada:	+1 (905) 475-6222
Mexico:	+52 (0) 55-1106-0800
Latin/S. America:	+54 (0) 11-4733-2200
Germany:	+49 (0) 6251-133-1999
UK:	+44 (0) 800-267666
France:	+33 (0) 1-3420-8686
Netherlands:	+31 (0) 73-6246-999
China:	+86 (0) 400-820-6015

te.com

TE Connectivity, TE, TE connectivity (logo), Linx and Linx Technologies are trademarks owned or licensed by the TE Connectivity Ltd. family of companies. All other logos, products and/or company names referred to herein might be trademarks of their respective owners.

The information given herein, including drawings, illustrations and schematics which are intended for illustration purposes only, is believed to be reliable. However, TE Connectivity makes no warranties as to its accuracy or completeness and disclaims any liability in connection with its use. TE Connectivity's obligations shall only be as set forth in TE Connectivity's Standard Terms and Conditions of Sale for this product and in no case will TE Connectivity be liable for any incidental, indirect or consequential damages arising out of the sale, resale, use or misuse of the product. Users of TE Connectivity products should make their own evaluation to determine the suitability of each such product for the specific application.

TE Connectivity warrants to the original end user customer of its products that its products are free from defects in material and workmanship. Subject to conditions and limitations TE Connectivity will, at its option, either repair or replace any part of its products that prove defective because of improper workmanship or materials. This limited warranty is in force for the useful lifetime of the original end product into which the TE Connectivity product is installed. Useful lifetime of the original end product may vary but is not warranted to exceed one (1) year from the original date of the end product purchase.

©2023 TE Connectivity. All Rights Reserved.

04/23 Original