

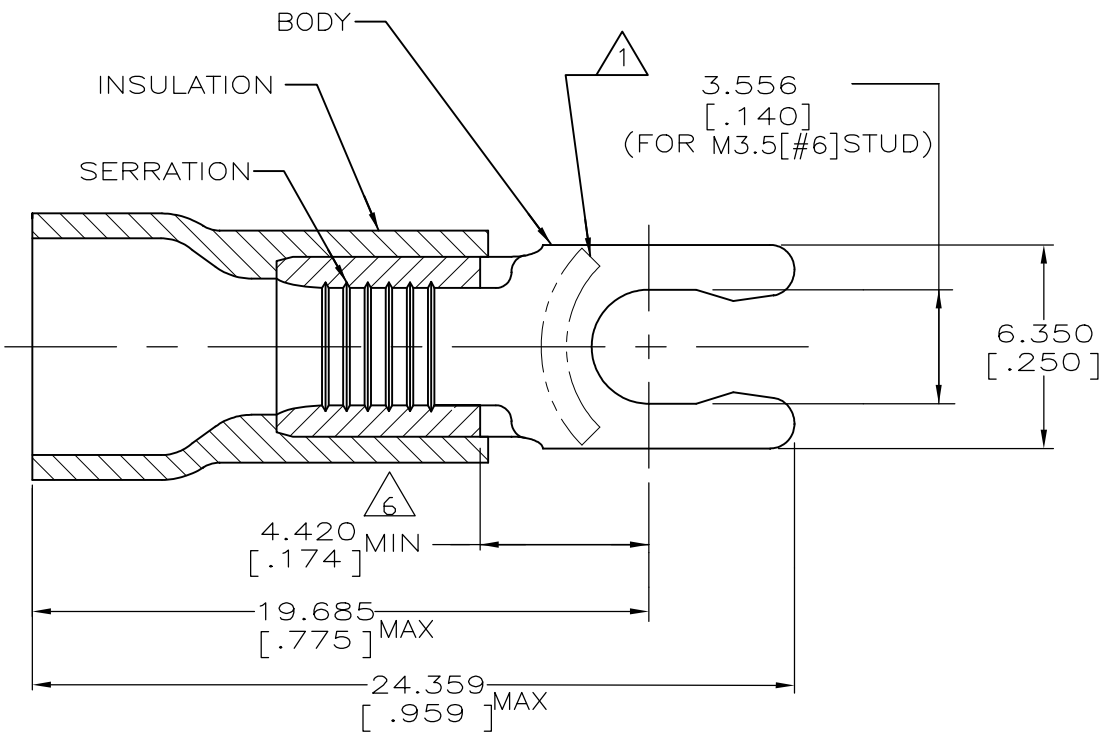



© - TE Connectivity. All Rights Reserved.



REVISIONS					
P	LTR	DESCRIPTION	DATE	DWN	APVD
	T3	REVISED PER ECR-25-257161	18SEP2025	SA	DSC

AMP WIRE RANGE	 Listed FILE E13288
12-10 AWG SOLID OR STRANDED	12 AWG STRANDED

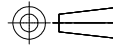

- 1  STAMP 6S AMP 12-10* APPROX AS SHOWN
- 2. WIRE INSULATION DIAMETER:
ø2.667[.105] TO ø5.080[.200]
- 3. BODY MATERIAL THK: 1.016±0.051[.040±.002]
- 4  MATERIAL:
BODY - BRASS PER ASTM B36
INSULATION - PVC
- 5  FINISH:
BODY - TIN PALTE 0.00254[.000100]
MIN EXT THK PER ASTM B545
INSUALTION COLOR - YELLOW
- 6  APPLIES FROM EDGE OF METAL WIRE BARREL TO
CENTER OF STUD HOLE

1 KIT = 100 PIECES	LOOSE PIECES	6-52961-0
2500	ON TAPE, REEL	52961-1
500	LOOSE PIECE	52961
QTY	PACKAGE TYPE	PART NO

AMP INCORPORATED CUSTOMER SERVICE SYSTEMS		MAX. RECOMMENDED OPERATING TEMPERATURE: 105°C [221°F]	THIS DRAWING IS A CONTROLLED DOCUMENT.		DWN L OLMEDA 26JUN95	 TE Connectivity					
FOR ADDITIONAL PRODUCT INFORMATION OR COPIES OF DRAWINGS AND TECHNICAL DOCUMENTS	PRODUCT INFORMATION CENTER 1-800-522-6752	VOLTAGE RATING: 600V MAX (1000V FIXTURE OR SIGN)	DIMENSIONS: mm [INCHES]	TOLERANCES UNLESS OTHERWISE SPECIFIED:	CHK M ELLIS 26JUN95	NAME TERMINAL, SPRING SPADE, SHORT, PLASTI-GRIP WIRE SIZE: 12-10 AWG					
FOR APPLICATION	TOOLING ASSISTANCE CENTER 1-800-722-1111	CIRCULAR MIL AREA: 2.62-6.64mm² [5,180-13,100] SOLID OR STRANDED		0 PLC ± - 1 PLC ± - 2 PLC ± 0.127[.005] 3 PLC ± - 4 PLC ± - 4 PLC ANGLES ± -	APVD G NGO 26JUN95	PRODUCT SPEC UL 486A-B	SIZE A3	CAGE CODE 00779	DRAWING NO C-52961	RESTRICTED TO -	
TOOLING INFORMATION	1-800-526-5142	THIS DRAWING IS A CONTROLLED DOCUMENT FOR AMP INCORPORATED. IT IS SUBJECT TO CHANGE AND THE CONTROLLING ENGINEERING ORGANIZATION SHOULD BE CONTACTED FOR THE LATEST REVISION.	MATERIAL 	FINISH 	APPLICATION SPEC 114-2161	WEIGHT -	CUSTOMER DRAWING		SCALE 6:1	SHEET 1 of 1	REV T3