

REVISIONS				
P	LTN	DESCRIPTION	DATE	APVD
A		REVISED PER ECN-23-208239	18APR2023	WH LC
A1		REVISED PER ECR-25-252934	06AUG2025	WH JH

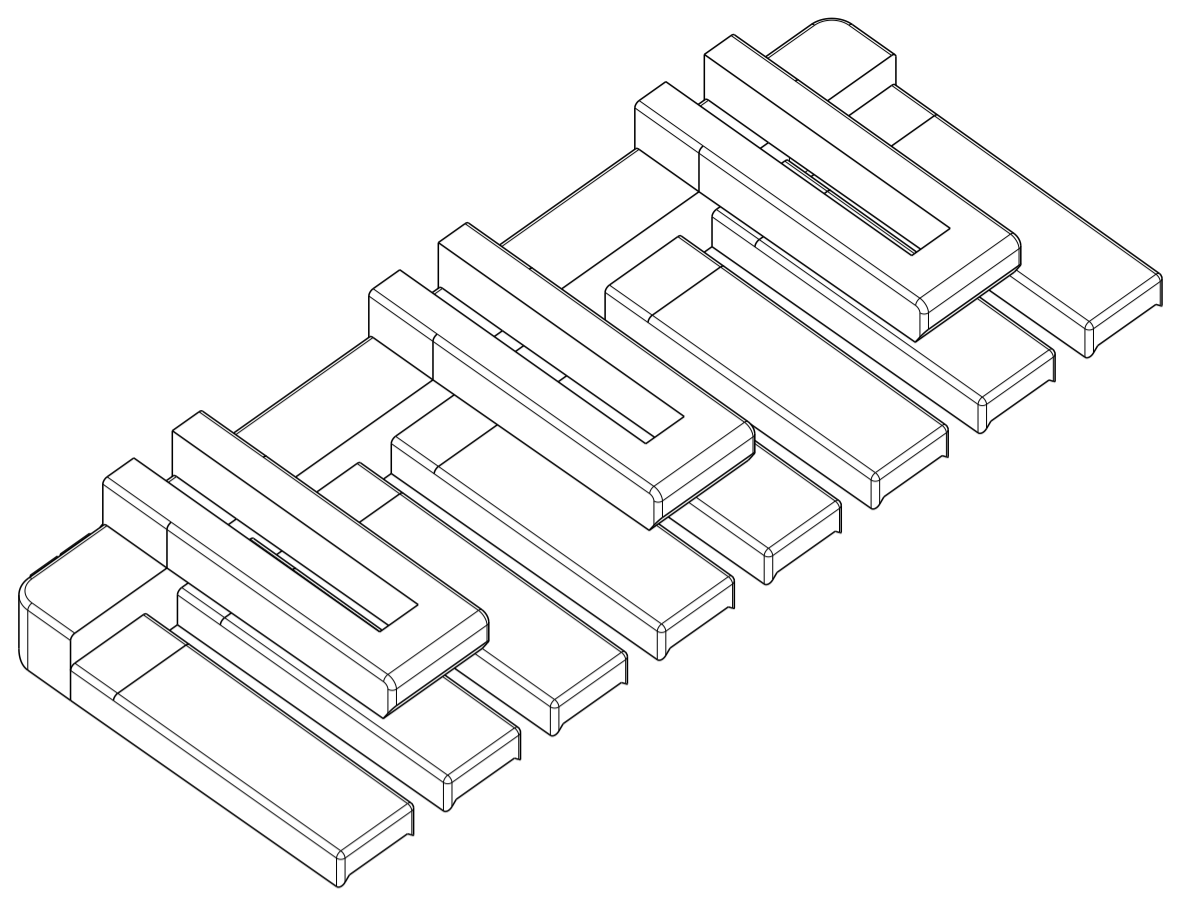

- △ MATERIAL: PBT,UL94 V-0, COLOR: BLACK
- DIMENSIONS SHOWN REPRESENT PRODUCT IN DRY, AS MOLDED, CONDITION. ADDITIONAL 2% GROWTH DUE TO SUBSEQUENT MOISTURE ABSORPTION MAY OCCUR AND SHOULD BE ACCOUNTED FOR.
 - RECOMMENDED MATING PARTS: 2391828-[]
 - PACKAGING: LOOSE PIECE.

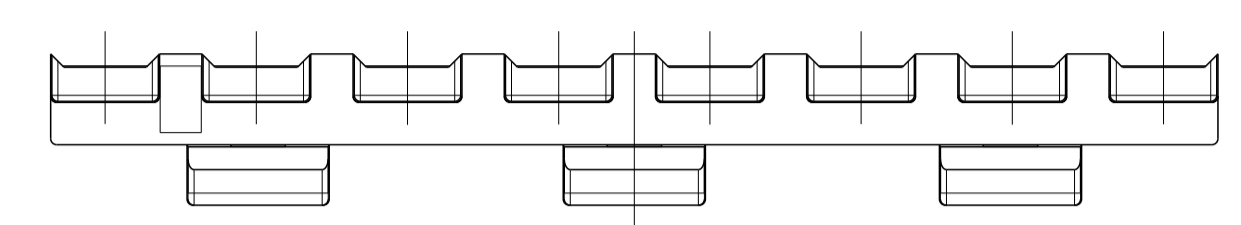
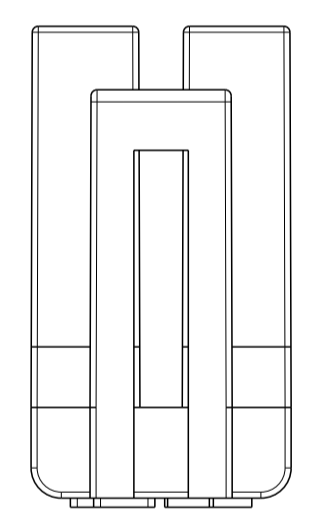
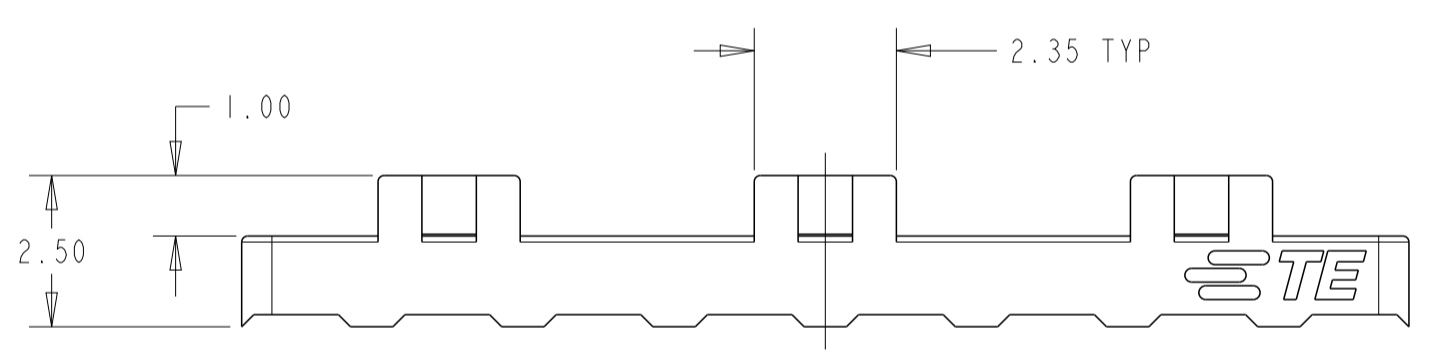
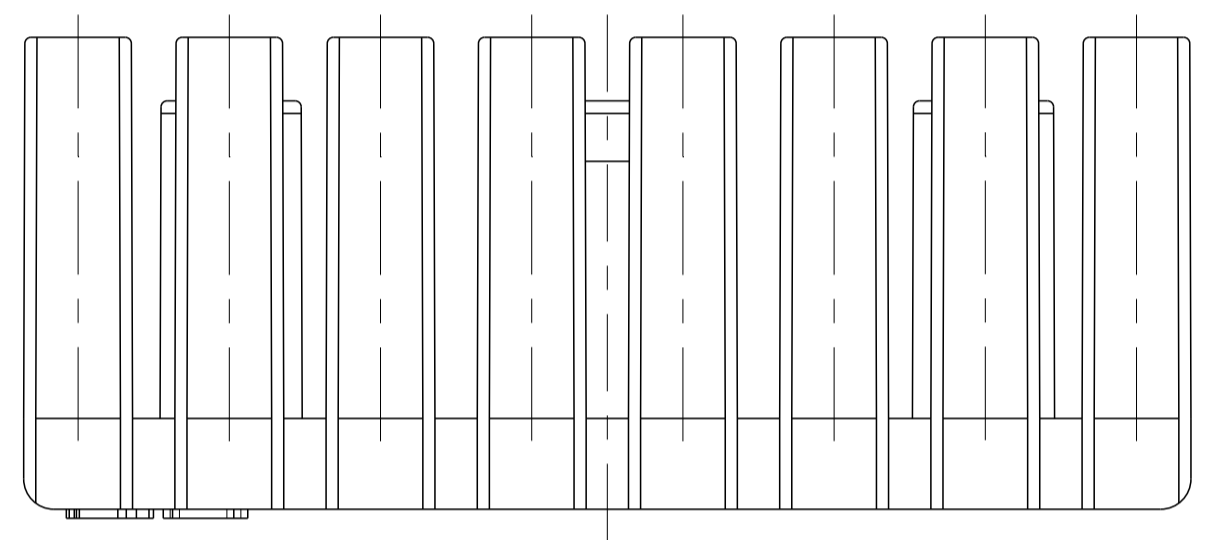
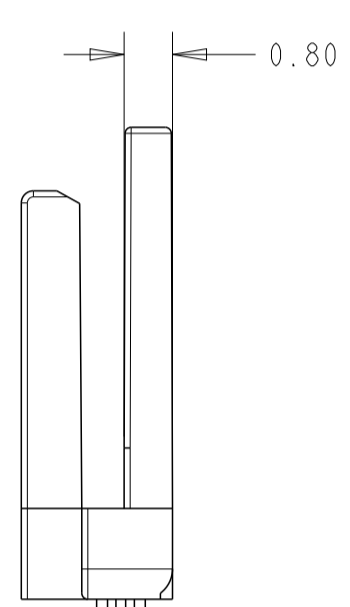
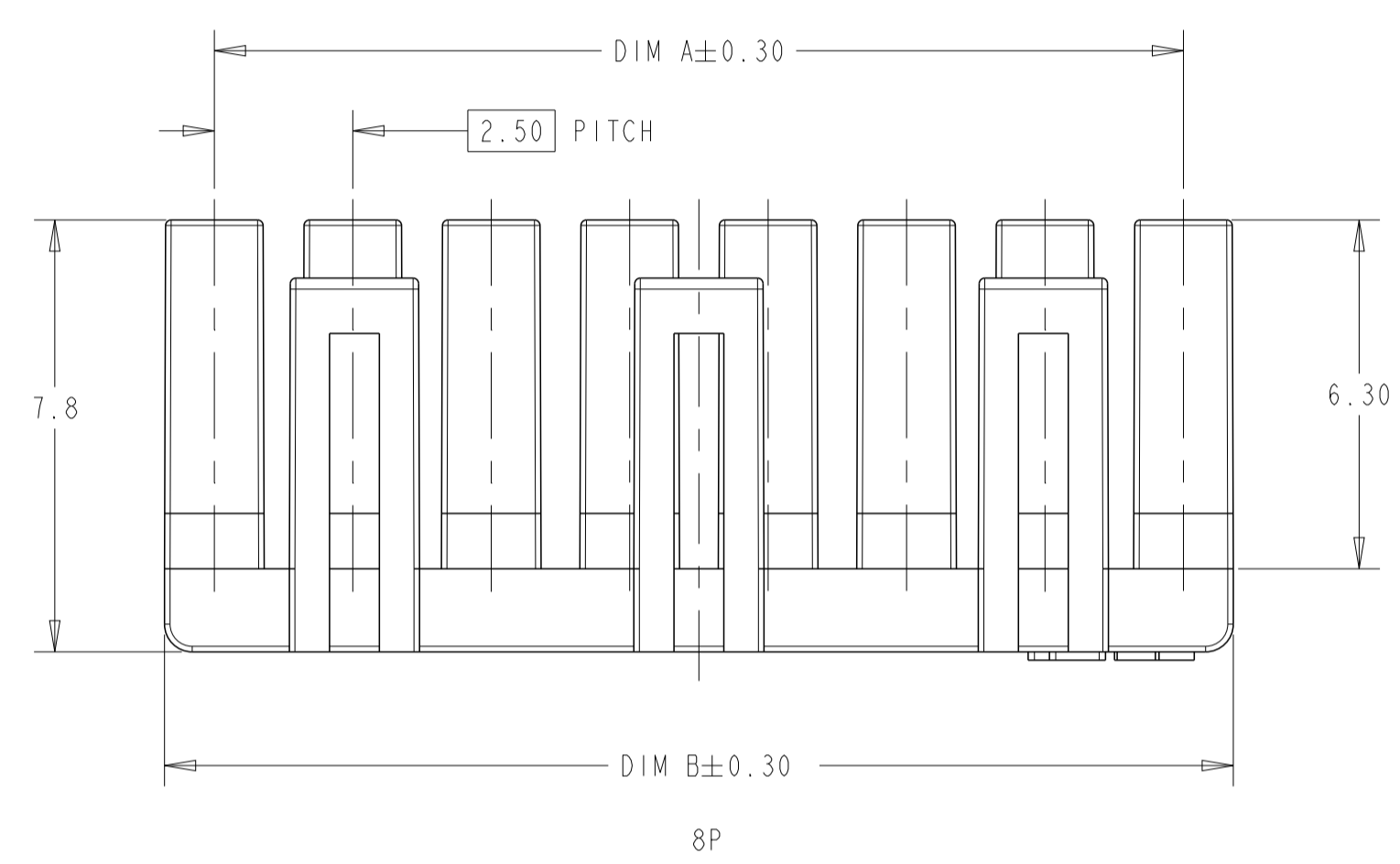

2P

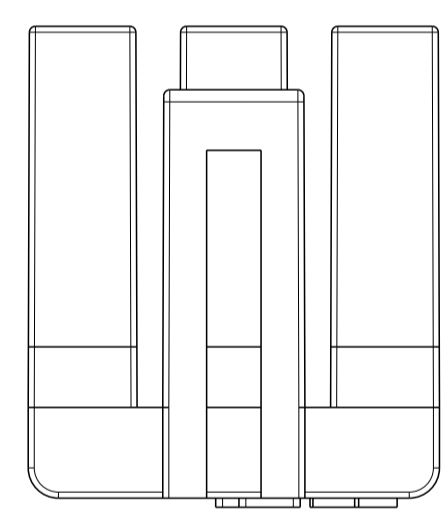

3P

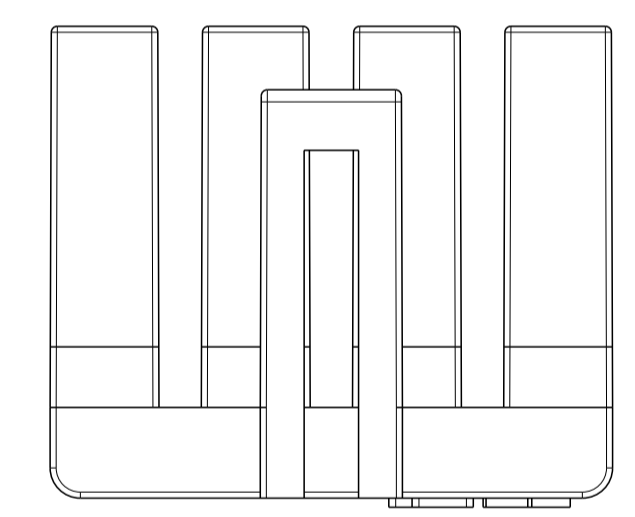

4P

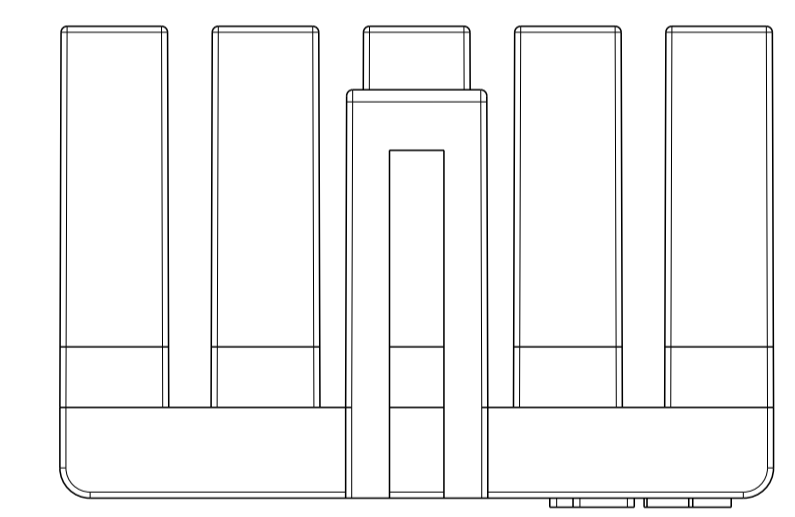

5P

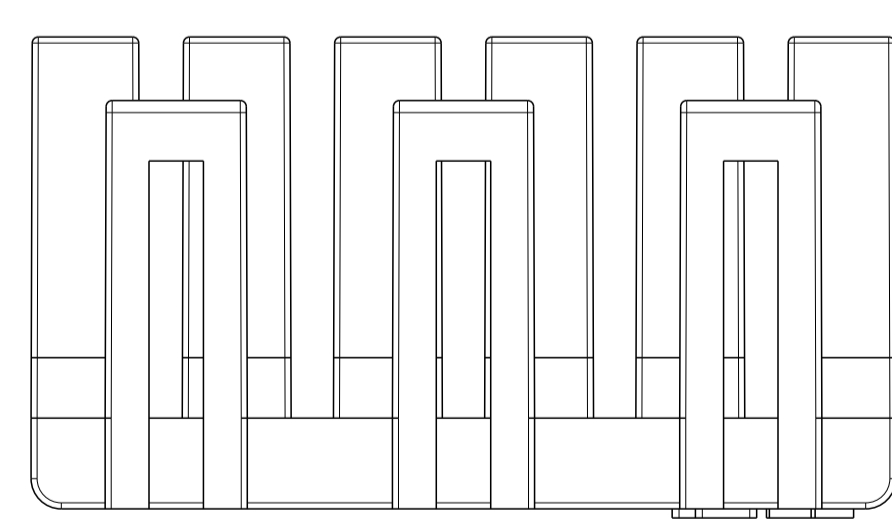

6P

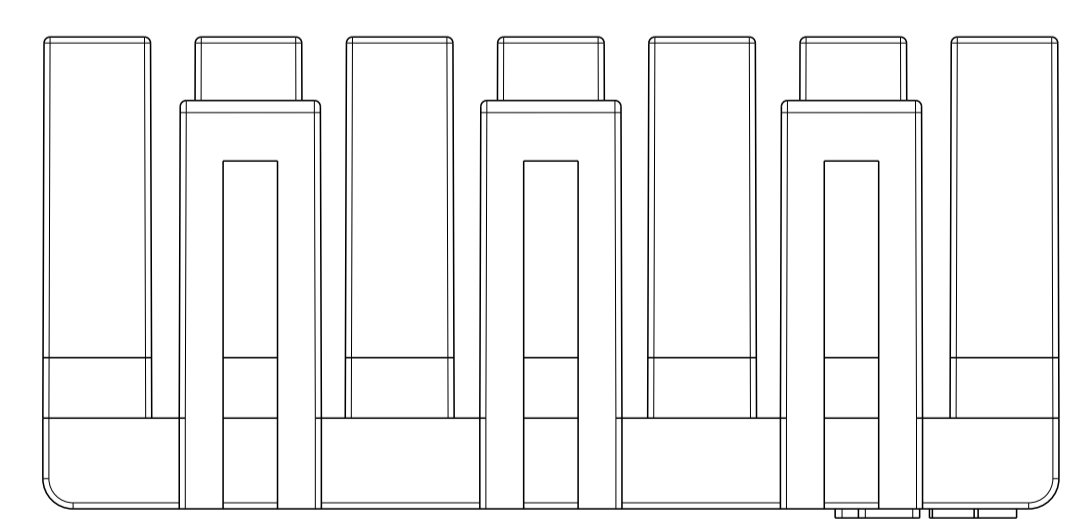

7P

DIM B	DIM A	NO OF POSITION	PART NUMBER
19.30	17.50	8	2391827-8
16.80	15.00	7	2391827-7
14.30	12.50	6	2391827-6
11.80	10.00	5	2391827-5
9.30	7.50	4	2391827-4
6.80	5.00	3	2391827-3
4.30	2.50	2	2391827-2

THIS DRAWING IS A CONTROLLED DOCUMENT.

DIMENSIONS:	TOLERANCES UNLESS OTHERWISE SPECIFIED:	DWN: HUO 28JUN2022	 TE Connectivity
mm	0 PLC ±0.4	CHK: L. CHEN 29JUN2022	
	1 PLC ±0.25	APVD: D. ZHANG 30JUN2022	
	2 PLC ±0.25		
	3 PLC ±0.25		NAME: TPA HOUSING
	4 PLC ±0.25		PRODUCT SPEC: 108-2418
	ANGLES ±0.5°		APPLICATION SPEC: 114-13315
MATERIAL: PBT	FINISH:	SIZE: 114-13315	RESTRICTED TO:
		WEIGHT: -	A 00779 C=2391827
		CUSTOMER DRAWING	SCALE: N/A SHEET 1 OF 1 REV: A1