

INTERCONNECT SOLUTIONS ALIGNED WITH THE SOSA™ TECHNICAL STANDARD

Increase Power, Speed and Bandwidth with Open Architecture
Solutions

SOSA®
Sensor Open Systems Architecture®

OpenVPX™

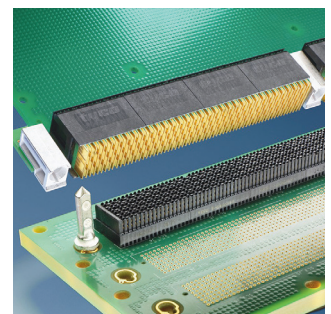
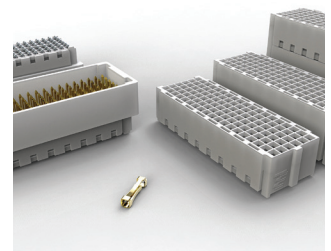
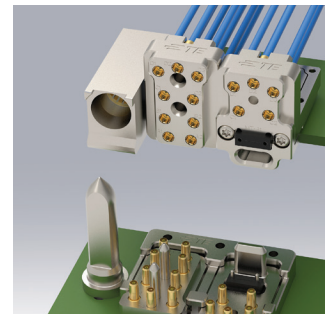
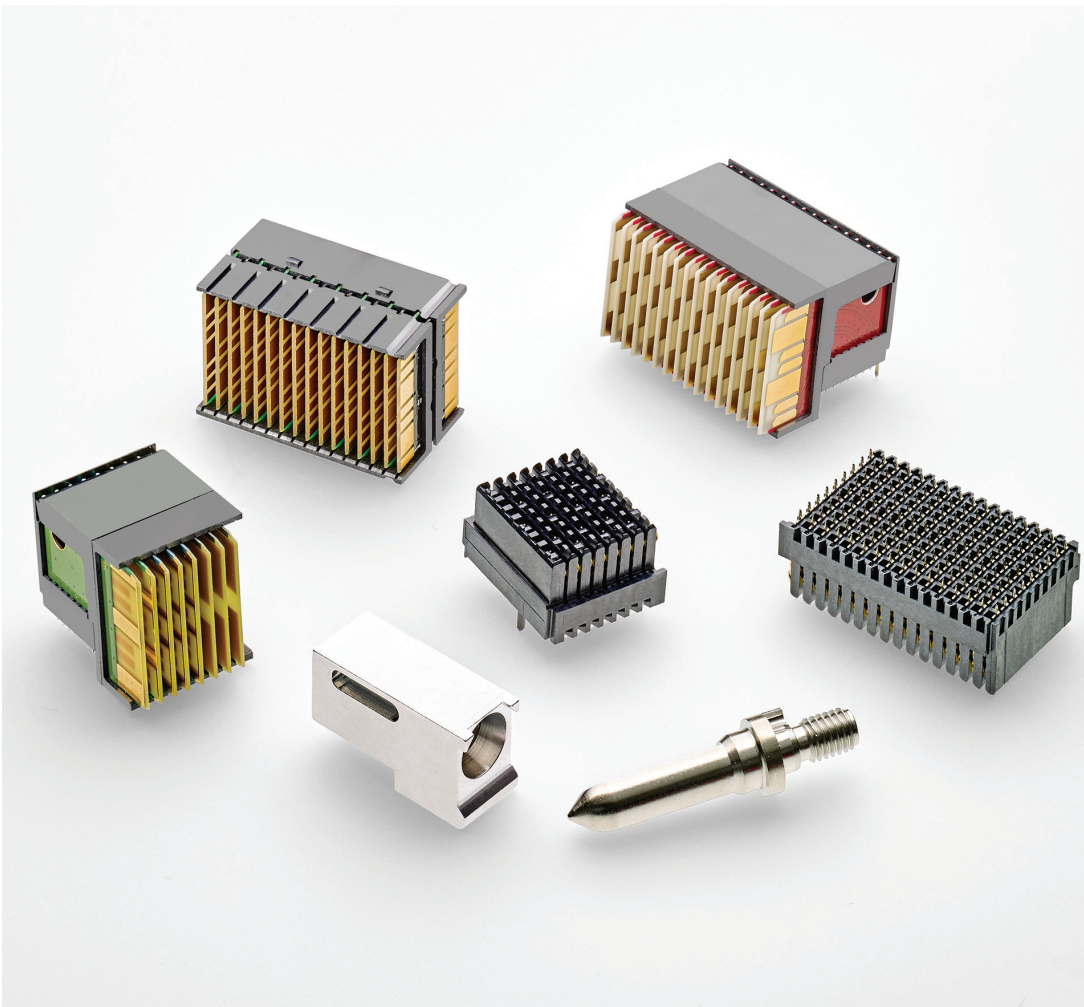

INTERCONNECT SOLUTIONS ALIGNED WITH THE SOSA™ TECHNICAL STANDARD



The Sensor Open Systems Architecture (SOSA) Consortium is developing a common framework for transitioning sensor systems to an open systems architecture, based on key interfaces and open standards established by industry-government consensus. These systems are targeted for platforms across all major U.S. military branches. Using OpenVPX as its basis, SOSA helps ensure interoperability, improved subsystem SWaP-C, and rapid technology upgrades.

Setting the Standard

TE Connectivity (TE) has been a leader in interconnect solutions for OpenVPX and an active member of the SOSA Consortium. The products in this brochure are aligned with the SOSA™ Technical Standard and targeted for design for next generation sensor systems and rugged embedded computing applications.

SWaP: Reduce Size and Weight

Increase Power, Speed and Bandwidth with Open Architecture Solutions

Next-generation processors need next-generation connectivity to keep pace with the growing demand for bandwidth even as space, weight, and power savings become critical.

TE has been pushing the bandwidth envelope by adapting high-speed technology and combining it with our expertise in rugged packaging. The results are board-level interconnects that give you more performance in harsh military and aerospace applications.

Beyond Speed

TE is also reducing size through higher contact densities and supporting RF and optical interconnects at the board level allowing compact, high-speed box-to-box connectivity. TE has a full range of copper and fiber I/O connectors supporting data rates up to 32+ Gb/s.

Meeting the Needs of Battlespaces

We are meeting the demanding needs of battlespaces with ruggedized copper and fiber interconnect and cable assemblies. And we are helping to protect systems with lightweight shielding and EMI-immune datapaths.

TE is focusing our technology to minimize size, weight and power consumption, to increase bandwidth, and to enable open architecture systems.

Table of Contents

Introduction.....	2
VITA 46 MULTIGIG RT and RT 2-R.....	3
VITA 46 MULTIGIG RT 2-S and RT 3.....	4
Guide Hardware.....	6
VITA 48.4 Liquid Cooled Modules.....	7
VITA 66 Optical and Coaxial.....	9
Mezalok VITA 61 XMC.....	12
VITA 62 Power Supply.....	13
I/O Interconnect.....	16
Multi-Mode Optical Termini.....	18
Complete Solutions.....	19

VITA 46 MULTIGIG RT CONNECTOR SYSTEM WITH DATA RATES TO 32+ GB/S (MODULAR)

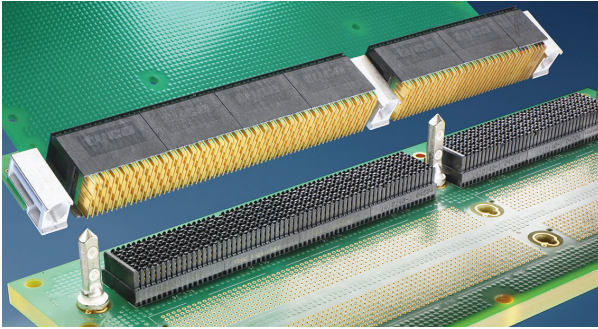

RUGGED

- The standard for VITA 46 applications
- Modular connector system features a protected backplane connector

FAST

- Supports speeds up to 32+ Gb/s, providing a comfortable performance margin in VPX applications

FLEXIBLE

- Wafers are easily modified to support the need for propagation delay, characteristic impedance, and other electrical parameters
- Lightweight connector offers built-in ESD features enabling field serviceability

The MULTIGIG RT connector, the standard for VITA 46, represents a huge step forward in the world of rugged computing and C5ISR enabling technology. The connector series supports speeds to 32+ Gb/s, providing a comfortable performance margin in VPX applications. This modular connector system features a protected pinless backplane connector and wafer-based design in place of pin contacts. Wafers, available for differential, single-ended, and power needs, can be easily modified to support specific customer needs for characteristic impedance, propagation delay, and other electrical parameters. This lightweight connector system also offers built in ESD features, enabling field serviceability, and is fully qualified for VITA 47 environment classes.

VITA 46 MULTIGIG RT 2-R CONNECTORS (ULTRA RUGGED)

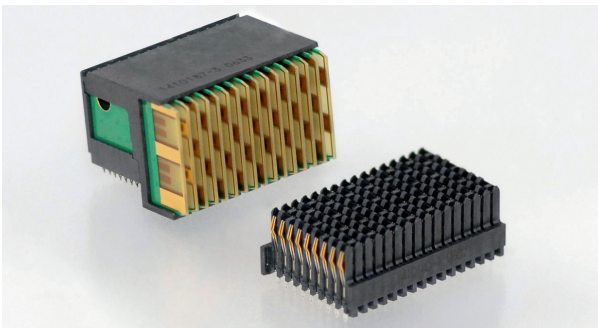

EXTREME RUGGEDNESS

- Passes extreme requirements of VITA 72 Study Group
- Features a quad-redundant contact system for greater reliability in a high vibration environment
- Specified for VITA 78 SpaceVPX applications

ULTRA FLEXIBLE

- Compatible with standard MULTIGIG RT-2 connectors for VITA 46
- Optimized footprints for signal integrity and ease of board design
- Low outgassing

MULTIGIG RT 2-R connectors are an evolution of MULTIGIG RT 2 connectors, designed to offer even more ruggedness and reliability in demanding high-vibration environments. They go beyond VITA 47 environmental performance to meet the demanding vibration requirements of VITA 72. These connectors are specified for VITA 78 SpaceVPX fault-tolerant interoperable backplanes and modules. The lightweight connectors offer low outgassing and resist the growth of tin whiskers for high reliability in the challenging environment of space. Backward compatible to all existing VITA 46 daughtercards, rugged MULTIGIG RT 2-R connectors have a pinless interface tested to 10,000 mating/unmating cycles. The connector has been tested to extreme vibration levels, including a 6U VPX test unit by exposing a 6U VPX test unit to random vibration levels of 0.2 g²/Hz for 12 hours.

VITA 46 MULTIGIG RT 2-S AND MULTIGIG RT 3 CONNECTORS (HIGHER SPEED)

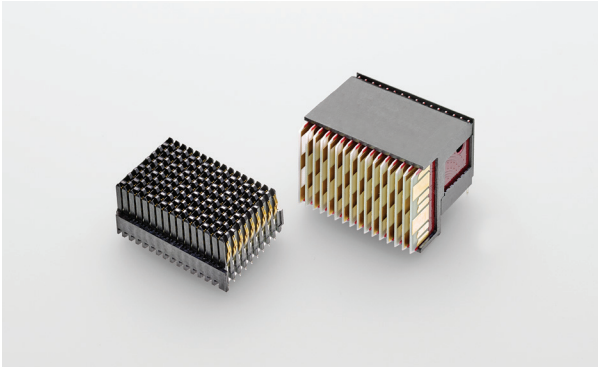

TE Connectivity's (TE) MULTIGIG RT 2-S and MULTIGIG RT 3 connectors are the next generation lightweight, rugged, high speed backplane connectors and meet the interface dimensions for VITA 46 VPX connectors. They are backward compatible with legacy MULTIGIG RT products and offer the same reliable ruggedized interface as MULTIGIG RT 2-R connectors. The new contact and wafer designs optimize signal integrity, extending data rates to 16-32+ Gb/s – supporting protocols such as PCIe Gen 4, Gen 5 and 100GBASE-KR4 Ethernet.

FAST

- Enhanced PCB wafer and contact design supports increased bandwidth up to 32+ Gb/s

FLEXIBLE

- Meets interface requirements for VITA 46 connectors allowing backward compatibility with legacy VPX products
- Customizable to meet unique application requirements

MODULAR

- Modular design enables numerous configurations by interchanging higher-speed MULTIGIG RT 3 connectors with the legacy MULTIGIG RT 2 and MULTIGIG RT 2-R connectors.

RUGGED

- Contact design utilizes quad redundant contacts for optimum performance in shock and vibration

DURABLE

- High durability tested for 10,000 mating/unmating cycle

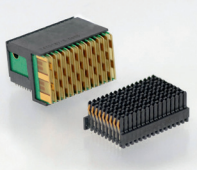
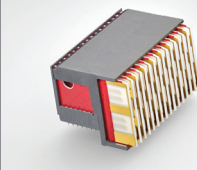
	 MULTIGIG RT 2-R Connector	 MULTIGIG RT 2-S Connector	 MULTIGIG RT 3 Connector
SPEEDS	10+ Gb/s	16+ Gb/s	32+ Gb/s
RUGGEDIZED	✓	✓	✓
MATING CYCLES	500	500	500
QUAD-REDUNDANT CONTACT SYSTEM	✓	✓	✓
FLEXIBILITY WITH WAFER CONFIGURATION	✓	✓	✓
VITA 46 INTERMATEABLE	✓	✓	✓
PCB HOLE DIAMETER BACKPLANE (in mm)	0.56 (ref)	0.56 (ref)	0.37 (ref)
PCB HOLE DIAMETER DAUGHTERCARD (in mm)	0.46 (ref)	0.46 (ref)	0.32 (ref)
RELEASE DATE	2013	2019	2019
OPEN VPX STANDARD	VITA 46.0	VITA 46.0	VITA 46.30

VITA 46 VPX PART NUMBERS

Position	RT 2		RT 2-R		RT 2-S	RT 3	RT 3 Highspeed with Power
	Differential	Single Ended	Differential	Single Ended	Differential	Differential	Differential
P0	1410189-3		2102772-1		2102772-1	2102772-1	2332816-1
P1, 2, 3, 4, 5, 6	1410187-3	1410190-3	2102771-1	2102847-1	2302317-1	2302785-1	
JO	1410186-1		2102735-1		2102735-1	2102735-1	2332817-1
J1, 3, 4, 5	1410140-1		2102736-1		2102736-1	2302789-1	
J2, 6	1410142-1		2371552-1		2371552-1	2364030-1	

See p. 6 for guide module and pin options.

MULTIGIG RT 2-S connectors are plug-in module only, and mate with RT 2, RT 2-R and RT 3 backplane connectors.

Part numbers with 93/7 tin-lead plated tails are listed above. See TE drawings for other plating options.

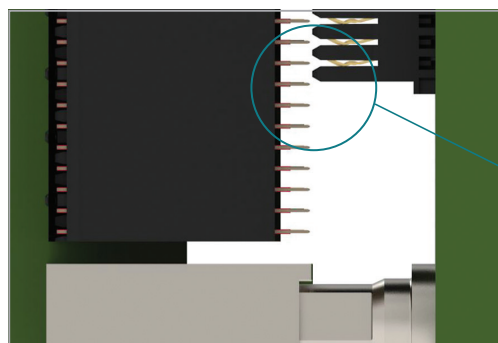
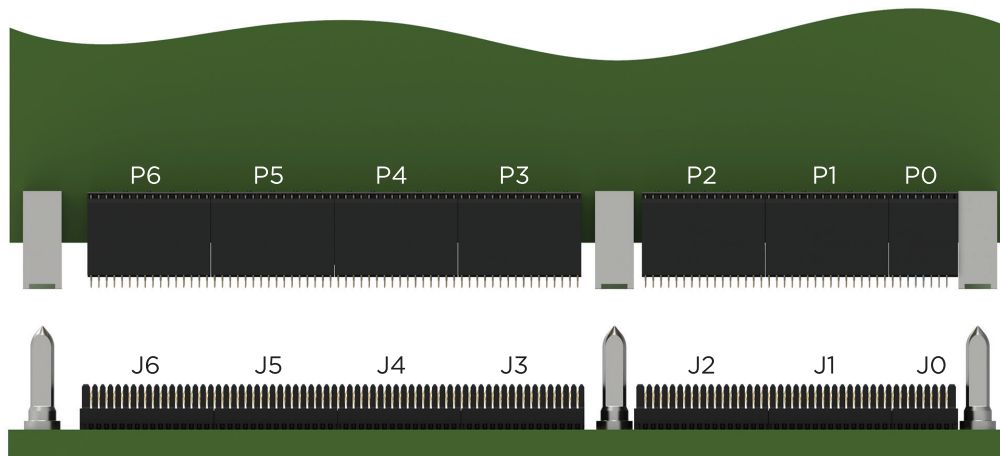

Thinner End Wall

The right end backplane connectors listed in the table include a thinner wall as specified by the SOSA standard - this eliminates the risk of damage to the plug-in module when a plug-in module has connectors extending beyond the backplane connector segment as shown

MODULES FOR VITA 66 AND 67 HALF MODULE 3U APPLICATIONS

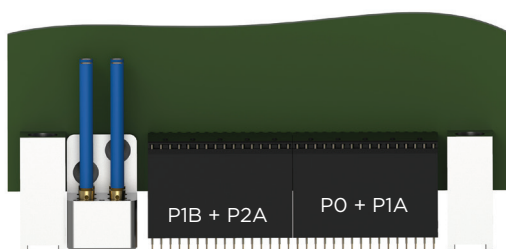

VITA 66 or 67 Half Module

Position	RT 2 (10 Gb/s)	RT 2-R (Rugged 10 Gb/s)	RT 2-S (16+ Gb/s)	RT 3 (32+ Gb/s)
P0 + P1A	1410326-3	2286250-1	2345723-1	2313237-1
JO + J1A	1410140-1	2102736-1	2102736-1 (RT 2-R)	2313238-1
P1B + P2A	1410187-3	2102771-1	2302317-1	2302785-1
J1B + J2A	1410142-1	2371552-1	2371552-1	2364030-1

See p. 6 for guide module and pin options.

MULTIGIG RT 2-S connectors are plug-in module only, and mate with RT 2, RT 2-R and RT 3 backplane connectors.

Part numbers with tin-lead plated tails are listed above. See TE drawings for RoHS options.

GUIDE HARDWARE

VITA 46 GUIDE MODULES - KEYING OPTIONS

Key Orientation (Degrees)	Standard (Diecast)	Rugged (Machined Aluminum)	Rugged (Machined Stainless Steel)
0	1-1469492-1	2000713-1	2000713-7
45	1-1469492-2	2000713-2	2000713-8
90	1-1469492-3	2000713-3	2000713-9
135		1-2000713-4	—
180		1-2000713-5	—
225		1-2000713-6	—
270	1-1469492-7	2000713-4	1-2000713-0
315	1-1469492-8	2000713-5	1-2000713-3
Without Keying	1-1469492-9	2000713-6	1-2000713-2

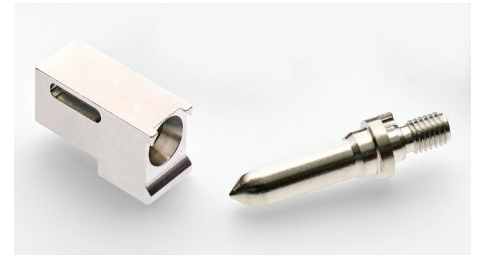

VITA 46 GUIDE PINS

Shoulder Depth into Backplane (Dim J)	External Thread				Internal Thread		
	Thread Length (Dim K)	Thread Type (External)	Rugged (Stainless Steel)	Diecast	Internal Thread Max Depth	Thread Type (Internal)	Rugged (Stainless Steel)
1.32	7.25	10-32 UNF	2000676-1		5.67	8-36 UNF	2327906-2
2.60	7.25	10-32 UNF	2000676-2	1-1469491-2	6.95	8-36 UNF	2327906-4
4.20	7.25	10-32 UNF	2000676-3	1-1469491-3	8.55	8-36 UNF	2327906-6
5.70	7.25	10-32 UNF	2000676-4	1-1469491-4	10.05	8-36 UNF	2327906-8
7.30	7.25	10-32 UNF	2000676-5		11.65	8-36 UNF	1-2327906-0
5.70	10.35	10-32 UNF	2000676-6				
3.40	9.00	M5 x 0.8 - 6g	2000676-7		7.75	M2 .5X.45	1-2327906-4
2.40	6.30	M5 x 0.8 - 6g	2000676-9		6.75	M2 .5X.45	1-2327906-8

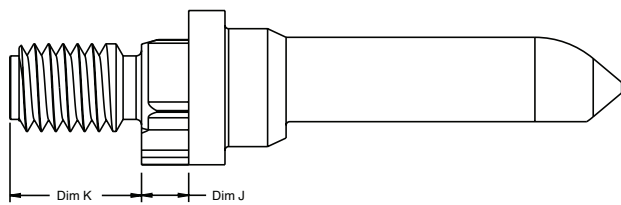

External Thread Guide Pins

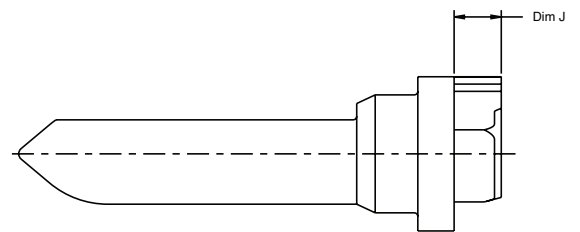

Internal Thread Guide Pins

VITA 48.4 LIQUID COOLED MODULES

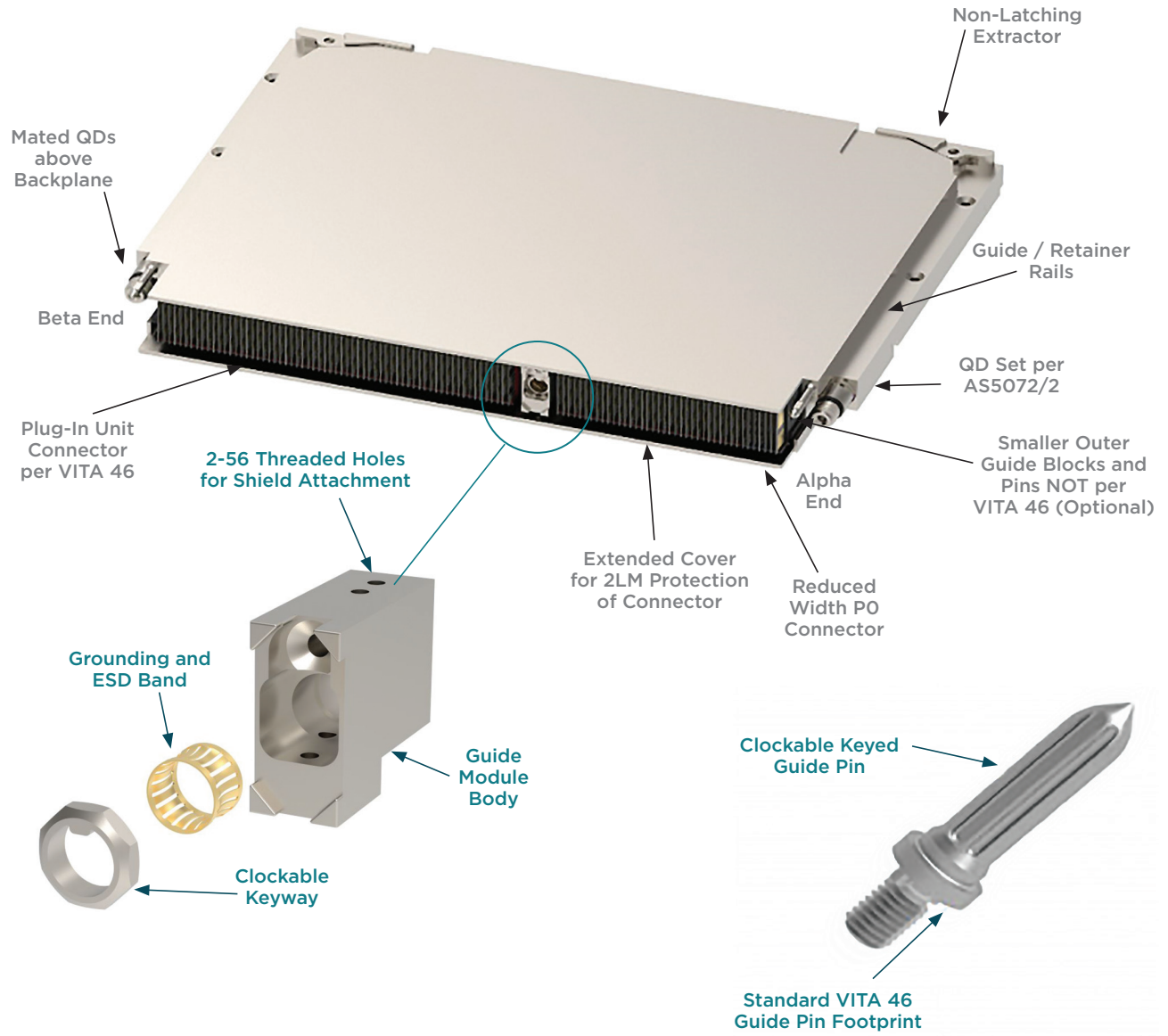

Description	Part Number
Guide Module (Daughtercard)	2828454-x
Guide Pin (Backplane)	2828999-x
PO Connector (Reduced Width), MULTIGIG RT 2-R	2226996-1

For P1-P6 Connectors, refer to table on p 8.
 For J0-J6 Connectors, refer to table on p 8.

VITA 48.4 LIQUID COOLED MODULES - GUIDE HARDWARE

Part Number	Secondary Key Angle
2828454-1	None
2828454-2	45°
2828454-3	90°
2828454-4	135°
2828454-5	180°
2828454-6	225°
2828454-7	270°
2828454-8	315°

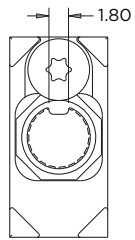

2828454-1
(Mates with
x-2828999-1)

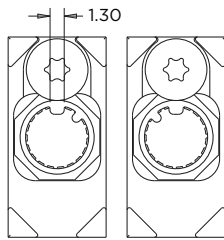

2828454-2
(Mates with
x-2828999-2)

2828454-8
(Mates with
x-2828999-8)

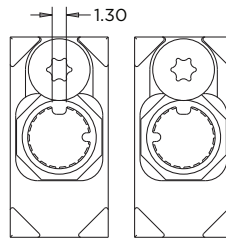

2828454-3
(Mates with
x-2828999-3)

2828454-7
(Mates with
x-2828999-7)

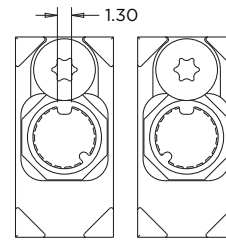

2828454-4
(Mates with
x-2828999-4)

2828454-6
(Mates with
x-2828999-6)

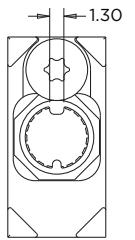

2828454-5
(Mates with
x-2828999-5)



X-2828999-1

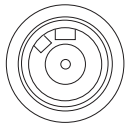

X-2828999-2

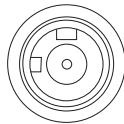

X-2828999-3

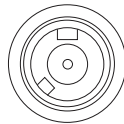

X-2828999-4

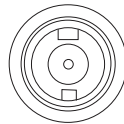

X-2828999-5

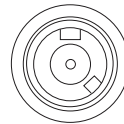

X-2828999-6

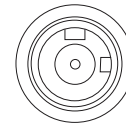

X-2828999-7

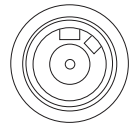

X-2828999-8

VITA 66 (OPTICAL) CONNECTOR MODULES

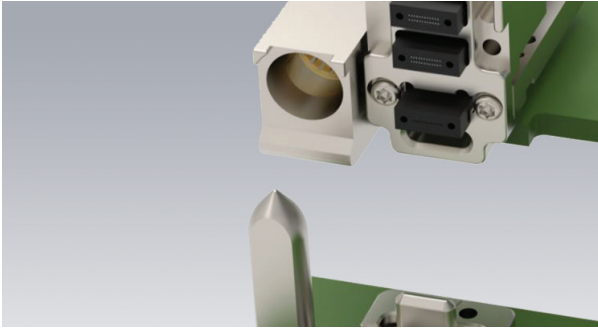

RUGGED RELIABILITY

- Receptacle (backplane) connector includes two robust guide pins for blind mating

VERSATILE

- Modules support VITA 66.5 standard
- Locating post features helps ensure proper positioning
- Ribbon cable feeds through backplane to removable system modules

TE Connectivity's (TE) Ruggedized Optical Backplane VITA 66 interconnect system provides a high-density, high-bandwidth, blind-mate optical interconnect in a backplane/daughtercard configuration. The fiber optic ribbon cable interconnect feeds through the backplane to removable system modules using MT ferrules. Designed for rugged embedded computing applications, the fiber optic connectors are compatible with VPX and other high-performance standards. Connector module designs support half and full size modules, with new, higher density variants now available.

TE's broad product line offers many possible configurations, including front panel MT connections to on board optical modules, direct attachment of transceivers to the bottom MT port, or to using a combination of optics and RF connections, all in a ruggedized blind mate structure.

VITA 67 (COAXIAL) CONNECTOR MODULES

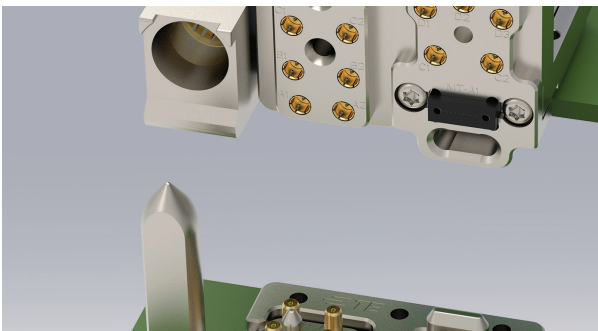

VERSATILE

- Modular design fully compatible with VPX packaging permits application specific configuration
- Available with SMPM contacts/modules and higher density NanoRF modules

RELIABLE

- Float mounted jack maintains positive coaxial ground
- Contacts tolerate generous misalignment to allow blind mating
- Contacts housed in robust stainless steel or aluminum modules

VITA 67 coaxial connector modules from TE are modular systems designed for backplane/daughtercard multi-coax contact mating within a robust platform to withstand the mechanical rigors of military and aerospace applications. They are also fully compatible with VPX packaging to make it easy and convenient to achieve coaxial connectivity within an open architecture.

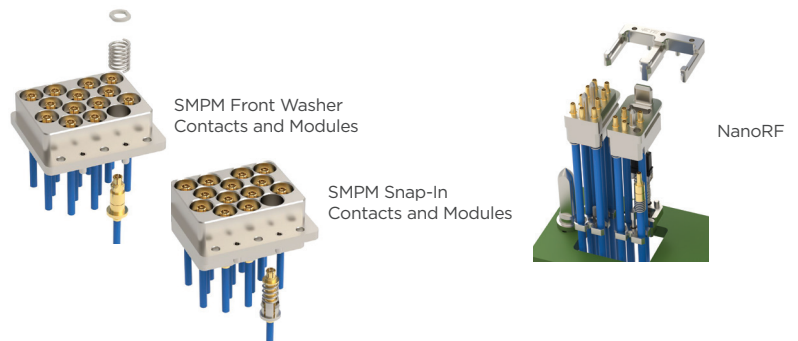

The contacts have radial and axial float for reliable blind mating and excellent coaxial performance. They are housed in robust stainless steel or aluminum modules, providing RFI/EMI shielding between the coaxial contacts with channel isolation of at least 100 dB up through 40-70 GHz.

TE offers SMPM contacts/modules and higher density 50 and 75 Ohm NanoRF modules, supporting 2-3 times the density of VITA 67 SMPM coaxial modules. The NanoRF interface features a floating insert to pre-align coaxial contacts before engagement. RF contact types are illustrated below.

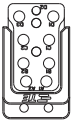
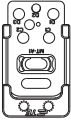

COAXIAL AND OPTICAL CONNECTOR MODULES

Half module

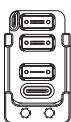
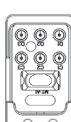
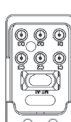
VITA 65 Module Designation	Backplane Module Layout			Connector Module Part Number	RF Contact Part Number (.086" Cable)	RF Contact Part Number (.047" Cable)	MT Ferrule Kit Part Number	Optical Plug-In Card Interface
6.4.5.7.2		9 NanoRF	Plug-In Module	2357976-1	—	2302339-1 (9 ea)	—	—
			Backplane	2357971-1	2332772-1 (8 ea)	2302345-1 (1 ea)	—	—
6.4.5.7.3		Style C-Hybrid 66.5 Insert with 5 NanoRF	Plug-In Module	2359407-1	—	2302339-1 (5 ea)	12-Fiber: 2355002-1 24-Fiber: 2355002-2	Cabled MT
			Backplane	2358435-1	—	2302339-1 (5 ea)	—	Transceiver
6.4.5.7.4		Style C-Hybrid 66.5 Insert with 10 NanoRF	Plug-In Module	2359410-1	—	2302339-1 (10 ea)	12-Fiber: 2355002-1 24-Fiber: 2355002-2	Cabled MT
			Backplane	2313388-1			—	—
6.4.5.7.6		Style D 66.5 Insert (3 MT)	Plug-In Module	2388442-1	—	—	12-Fiber: 2375154-1 24-Fiber: 2375154-2	3 Cabled MT
			Backplane	2388440-1			—	—
6.4.5.7.7		Style C-Hybrid 66.5 Insert with 6 75-Ohm NanoRF	Plug-In Module	2402888-1	2401219-1 (75 ohm Cable)	—	12-Fiber: 2355002-1 24-Fiber: 2355002-2	Cabled MT
			Backplane	2432281-1			—	—
6.4.5.7.7		Style C-Hybrid 66.5 Insert with 6 75-Ohm NanoRF	Plug-In Module	2402889-1	2401218-1 (75 ohm Cable)	—	12-Fiber: 2332756-1 24-Fiber: 2332756-2	—
			Backplane	2402889-1			—	—

COAXIAL AND OPTICAL CONNECTOR MODULES

Full module VITA 65 Aperture H Backplane per VITA 67.3C

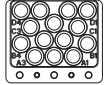
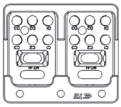
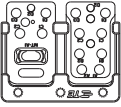
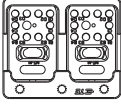
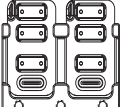
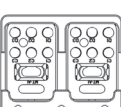
VITA 65 Module Designation	Backplane Module Layout		Connector Module Part Number	RF Contact Part Number (.086" Cable)	RF Contact Part Number (.047" Cable)	MT Ferrule Kit Part Number	Optical Plug-In Card Interface
6.4.5.6.4		14 pos SMPM	Plug-In Module	2332829-3	2101012-1	2157248-1	—
			Backplane (Snap-in Contacts)	2361107-1	2332676-1	2332676-2	—
			Backplane (Front Washer Contacts)	2332827-2	1996390-1	1996771-1	—
6.4.5.6.8		2 Style C-Hybrid 66.5 Inserts with 10 NanoRF	Plug-In Module	2359407-1 (2 ea)	—	2302339-1 (10 ea)	12-Fiber: 2355002-1 24-Fiber: 2355002-2
			Backplane	2358435-1 (2 ea)	2332772-1 (8 ea)	2302345-1 (2 ea)	— 12-Fiber: 2332756-1 24-Fiber: 2332756-2
6.4.5.6.9		1 Style C-Hybrid 66.5 insert with 14 NanoRF	Plug-In Module	2359407-1 + 2357976-1	—	2302339-1 (14 ea)	12-Fiber: 2355002-1 24-Fiber: 2355002-2
			Backplane	2358435-1	2332772-1 (12 ea)	2302345-1 (2 ea)	— 12-Fiber: 2332756-1 24-Fiber: 2332756-2
6.4.5.6.10		2 Style C-Hybrid 66.5 Inserts with 20 NanoRF	Plug-In Module	2359410-1 (2 ea)	—	2302339-1 (20 ea)	12-Fiber: 2355002-1 24-Fiber: 2355002-2
			Backplane	2313388-1 (2 ea)	2378048-1	2302345-1 (20 ea)	— 12-Fiber: 2332756-1 24-Fiber: 2332756-2
6.4.5.6.11		2 Style D VITA 66.5 Inserts	Plug-In Module	2388442-1 (2 ea)	—	—	12-Fiber: 2375154-1 24-Fiber: 2375154-2
			Backplane	2388440-1 (2 ea)	2388444-1	—	12-Fiber: 2375154-1 24-Fiber: 2375154-2
6.4.5.6.12		2 Style C-Hybrid 66.5 Inserts with 12 75-Ohm NanoRF	Plug-In Module	2402888-1 (2 ea)	2401219-1 (75 ohm Cable)	—	12-Fiber: 2355002-1 24-Fiber: 2355002-2
			Backplane	2432281-1 (2 ea)	2401218-1 (75 ohm Cable)	—	— 12-Fiber: 2332756-1 24-Fiber: 2332756-2

VITA 66.5 TRANSCEIVER KITS

Transceiver Kit TE Part Number	Channel Count	Tx/Rx	Rx Sens (dBm)	Max Data Rate G	Application	Plug Kit Part Number: Included in Transceiver Kit Part Number	Mating Backplane Connector Part Number Half Width	Mating Backplane Connector Part Number Full Width	66.5 Style
2394052-4	12	Rx	-7.5	28	1 MT + 5 nanoRF	2358435-1	2358431-1	2358791-1	C-Hybrid
2393875-1	4	TxRx	-7.5	28	3 MT	2388440-1	2388438-1	2388444-1	D
2393875-3	12	Tx	—	28	3 MT	2388440-1	2388438-1	2388444-1	D
2393875-4	12	Rx	-7.5	28	3 MT	2388440-1	2388438-1	2388444-1	D
2394053-1	4	TxRx	-12	10	1 MT + 10 nanoRF	2313388-1	2313391-1	2363793-1	C-Hybrid
2394053-2	4	TxRx	-9	10	1 MT + 10 nanoRF	2313388-1	2313391-1	2363793-1	C-Hybrid
2394053-3	12	Tx	—	10	1 MT + 10 nanoRF	2313388-1	2313391-1	2363793-1	C-Hybrid
2394053-4	12	Rx	-12	10	1 MT + 10 nanoRF	2313388-1	2313391-1	2363793-1	C-Hybrid
2394054-1	4	TxRx	-12	10	1 MT + 5 nanoRF	2358435-1	2358431-1	2358791-1	C-Hybrid
2394054-2	4	TxRx	-9	10	1 MT + 5 nanoRF	2358435-1	2358431-1	2358791-1	C-Hybrid
2394054-3	12	Tx	—	10	1 MT + 5 nanoRF	2358435-1	2358431-1	2358791-1	C-Hybrid
2394054-4	12	Rx	-12	10	1 MT + 5 nanoRF	2358435-1	2358431-1	2358791-1	C-Hybrid
2394055-1	4	TxRx	-12	10	3 MT	2388440-1	2388438-1	2388444-1	D
2394055-2	4	TxRx	-9	10	3 MT	2388440-1	2388438-1	2388444-1	D
2394055-3	12	Tx	—	10	3 MT	2388440-1	2388438-1	2388444-1	D
2394055-4	12	Rx	-12	10	3 MT	2388440-1	2388438-1	2388444-1	D

RUGGED MEZALOK VITA 61 XMC CONNECTORS

RUGGED

- Surface-mount mezzanine connector with 500 mating cycle durability
- Superior thermal cycling stability—2000 thermal shock cycles -55°C to +85°C
- Anti-stubbing design prevents mis-mating

VERSATILE

- 114 position in 10, 12, 15, 17 and 18 mm stack heights
- Support single-width and double-width mezzanine cards

HIGH PERFORMANCE

- Redundant box contact system provides four points of contact for ultra-reliability
- High-temperature polymer housings offer superior thermal stability and low outgassing
- Compliant BGA board-attach supports standard surface mount processing and thermal stability
- Supports data rates up to 32+ Gb/s
- HSLF products offer up to 50% lower extraction force

TE's Mezalok mezzanine connectors are designed for stacking or mezzanine applications for rugged embedded computing. The connectors incorporate a multi-point redundant box contact system for a separable interface, and the 114 position connectors are compliant with VITA 61.0 XMC standard. Stack height options are 10, 12, 15, 17 and 18 mm. Mezalok connectors are shock and vibration resistant per VITA 47 and 72 HALT test requirements. Featuring a wide operating temperature range, excellent thermal stability, and data rates to 32+ Gb/s, these rugged and highly versatile connectors are ideal for high-speed embedded computing applications. Installation of Mezalok connectors is easily accomplished using standard ball grid array (BGA) surface mount processes.

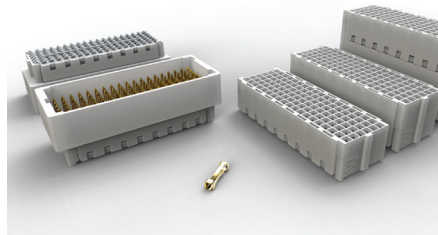

Position Size	Connector and Stack Height (mm)	High Speed Low Extraction Force (HSLF)		High Speed (HS)				
		50 Microinch Gold Mating		50 Microinch Gold Mating		30 Microinch Gold Mating		
		Tin-Lead BGA	Lead Free BGA	Tin-Lead BGA	Lead Free BGA	Tin-Lead BGA	Lead Free BGA	
114	Pin Connector	2102060-1	2102060-2	2102060-1	2102060-2	2102060-3	2102060-4	
	Socket Connector	10	2355825-1	2355825-2	2102061-1	2102061-2	2102061-5	2102061-6
		12	2355825-3	2355825-4	2102061-3	2102061-4	2102061-7	2102061-8
		15			1-2102061-3	1-2102061-4	1-2102061-5	1-2102061-6
		17	1-2355825-7	1-2355825-8	1-2102061-7	1-2102061-8		
		18	2355825-9	1-2355825-0	2102061-9	1-2102061-0	1-2102061-1	1-2102061-2

VITA 62 POWER SUPPLY CONNECTORS



HIGH PERFORMANCE

- 20 A and 50 A power contacts, plus signal contacts
- 3-beam high-conductivity-copper contact design
- Hot-plug capable
- 270VDC applications supported by connectors with isolating fins (VITA 62.2)
- 3-phase power configurations (VITA 62.1)

The MULTI-BEAM XLE power connector, specified for the VPX VITA 62 power supply standard, offers 50 A and 20 A power contacts as well as signal pins within the same connector assembly. The design is hot pluggable, tolerates mating misalignment, and supports VPX architecture.

Higher input voltage of 270VDC is required for select applications, including altitudes of 60-70k ft for military avionics. New VITA 62.1 (3-phase) and 62.2 (standard) connector variations meet creep/clearance distance requirements, with slots required in the boards between contacts. “Fins” are inserted between power contacts and penetrate through the board slots to increase breakdown voltage.

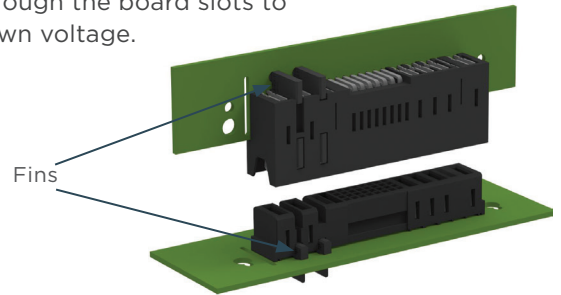

270V DC Connector

	Slot Size	Position	Part Type	PCB Termination	Part No	Alternate PN (Accepts High Voltage Separating Fins)	Fins for Higher Voltage Application
VITA 62.0	3U	PO	RA Header	Solder Tail	2317477-1		
		PO	RA Header	Compliant Pin	2314578-2	2313442-1	
		JO	Vert Recpt	Compliant Pin	2309390-1	2313441-1	
	6U	PO	RA Header	Solder Tail	2314579-1		
		P1	RA Header	Solder Tail	2314580-1		
		PO	RA Header	Compliant Pin	2314577-1	2348886-1	
		P1	RA Header	Compliant Pin	2314578-1		
JO	Vert Recpt	Compliant Pin	2314581-1	2348888-1			
J1	Vert Recpt	Compliant Pin	2309390-2				
VITA 62.2 270 VDC	3U	PO	RA Header	Solder Tail	2313443-1		2313445-1 (2 per)
		PO	RA Header	Compliant Pin	2313442-1		2313445-1 (2 per)
		JO	Vert Recpt	Compliant Pin	2313441-1		2313444-1 (2 per)
	6U	PO	RA Header	Compliant Pin	2348886-1		2313445-1 (6 per)
		P1	RA Header	Compliant Pin	2314578-1		
		JO	Vert Recpt	Compliant Pin	2348888-1		2313444-1 (6 per)
		J1	Vert Recpt	Compliant Pin	2309390-2		
VITA 62.1 3-phase	3U	PO	RA Header	Solder Tail	2332791-1		2313445-1 (6 per)
		PO	RA Header	Compliant Pin	2332793-1		2313445-1 (6 per)
		JO	Vert Recpt	Compliant Pin	2332795-1		2313444-1 (6 per)

I/O INTERCONNECT

J CONNECTORS

Function	Designator	Purpose		Type	Sensor LRU Gender	Platform Umbilical Gender
Power	J1	DC Power	28 VDC	MIL-DTL-38999/ Series III	Receptacle with Pin Inserts	Plug with Socket Inserts
	J6	Aux DC Power	28 VDC	MIL-DTL-38999/ Series III	Receptacle with Pin Inserts	Plug with Socket Inserts
	J10	AC Power	115 VAC, 1 or 3 phase	MIL-DTL-38999/ Series III	Receptacle with Pin Inserts	Plug with Socket Inserts
	J11	High Voltage DC	270 VDC	MIL-DTL-38999/ Series III	Receptacle with Pin Inserts	Plug with Socket Inserts
	J16	External Battery	3.3 VDC / 3.6 VDC	MIL-DTL-38999/ Series III	Receptacle with Pin Inserts	Plug with Socket Inserts
Discrete RF	J2	GPS Antenna	SMA	MIL-PRF-39012	Receptacle	Plug
	J5	Antenna	TNC	MIL-PRF-39012	Receptacle	Plug
	J17	RF Connector	TNC	MIL-PRF-39012	Receptacle	Plug
	J18	RF Connector	SMA	MIL-PRF-39012	Receptacle	Plug
Multi-Pin RF	J8	High Density RF		MIL-DTL-38999/ Series III	Receptacle with Socket Inserts	Plug with Pin Inserts
	J9	Low Loss RF		MIL-DTL-38999/ Series III	Receptacle with Socket Inserts	Plug with Pin Inserts
Fiber	J4	Fiber Optic		MIL-DTL-38999/ Series III	Receptacle with Socket Inserts	Plug with Pin Inserts
	J14	High Density Fiber		VITA 87.0	Receptacle with 4 MTs	Plug with Socket Inserts
	J15	High Density Fiber		VITA 87.0	Receptacle with 1 MT	Plug with Socket Inserts
	J27	High Density Fiber		VITA 87.0	Receptacle with 4 Lensed MTs	Plug with Socket Inserts
	J28	High Density Fiber		VITA 87.0	Receptacle with 1 Lensed MT	Plug with Socket Inserts
	J30	High Density Fiber		VITA 87.0	Receptacle with 2 MTs	Plug with Socket Inserts
	J31	High Density Fiber		VITA 87.0	Receptacle with 2 Lensed MT	Plug with Socket Inserts
High Speed Copper	J7	High Speed Copper		VITA 76.0	Receptacle	Plug
	J35	High Speed Ethernet and Discretes (Copper)		VITA 76.0	Receptacle	Plug
	J36	High Speed Copper		MIL-DTL-32546A	Receptacle with 1 Socket Insert	Plug with Pin Inserts
	J37	High Speed Copper		MIL-DTL-32546A	Receptacle with 4 Socket Inserts	Plug with Pin Inserts
Hybrid Signal	J1	Multi		Micro-D	Receptacle with Socket Inserts	Plug with Pin Inserts
	J2	Signal		MIL-DTL-38999/ Series III	Receptacle with Socket Inserts	Plug with Pin Inserts
Video	J3	Video (Copper)		MIL-DTL-38999/ Series III	Receptacle with Socket Inserts	Plug with Pin Inserts
	J29	High Speed Video		MIL-DTL-38999/ Series III	Receptacle with Socket Inserts	Plug with Pin Inserts

Shell Size	Keying	Insert	Panel Interconnect			I/O Cable Interconnect		
			Connector Part Number	Contacts MIL Part Number	Contacts	Connector Part Number	Contacts MIL Part Number	Contacts
21	N	21-11	D38999/20*G11PN	M39029/58-365	Included with Connector	D38999/26*G11SN	M39029/56-353	Included with Connector
19	N	19-11	D38999/20*F11PN	M39029/58-364	Included with Connector	D38999/26*F11SN	M39029/56-352	Included with Connector
17	N	17-8	Not Currently Supplied by TE	M39029/58-364		Not Currently Supplied by TE	M39029/56-352	
19	A	19-11	Not Supplied by TE					
17	N	17-6	D38999/20*E6PN-LC	Not Currently Supplied by TE		D38999/26*E6SN	M39029/56-353	Included with Connector
15	N	15-5	Not Supplied by TE					
11	N	11-5	D38999/20*B5PN	M39029/58-363	Included with Connector	D38999/26*B5SN	M39029/56-351	Included with Connector
9	N	9-35	D38999/20*A35PN	M39029/58-360	Included with Connector	D38999/26*A35SN	M39029/56-348	Included with Connector
N/A	N/A	N/A	Contact TE for Connector Options					
N/A	N/A	N/A	Contact TE for Connector Options					
N/A	N/A	N/A	Contact TE for Connector Options					
N/A	N/A	N/A	Contact TE for Connector Options					
25	N	25-19	D38999/20*J19BN	N/A	2389333-1 (.086" Cable) 2500687-1 (.047" Cable)	Not Currently Supplied by TE	N/A	2389332-1 (.086" Cable) 2500686-1 (.047" Cable)
21	N	21-11	D38999/20*G11BN	N/A	2389333-1 (.086" Cable) 2500687-1 (.047" Cable)	D38999/26*G11AN	N/A	2389332-1 (.086" Cable) 2500686-1 (.047" Cable)
25	N	25-8	D38999/20*J10BN	N/A	Not Supplied by TE	D38999/26*J10AN	N/A	Not Supplied by TE
21	N	21-75	D38999/20*G75BN	N/A	Not Supplied by TE	D38999/26*G75AN	N/A	Not Supplied by TE
19	N	19-11	Not Currently Supplied by TE	M29504/5-XXX	See Page 18	Not Currently Supplied by TE	M29504/4-XXX	See Page 18
13	N	13-4	D38999/20*C4BN	M29504/5-XXX	See Page 18	D38999/26*C4AN	M29504/4-XXX	See Page 18
15	N	N/A	2358897-x *	N/A	2375154-x *	2358899-x *	N/A	2375153-x *
11	N	N/A	2358902-x *	N/A	2375154-x *	2358904-x *	N/A	2375153-x *
15	A	N/A	Contact TE for Options					
11	A	N/A	Contact TE for Options					
13	N	N/A	2358900-x *	N/A	2375154-x *	2358901-x *	N/A	2375153-x *
13	A	N/A	Contact TE for Options					
17	N	N/A	Not Supplied by TE					
17	A	N/A	Not Supplied by TE					
11	N	N/A	CFX20*1108S*N**** (See Table on Page 16, 17 for Options to Replace *)	N/A	Included with Connector	CFX26*1108P*N**** (See Table on Page 16, 17 for Options to Replace *)	N/A	Included with Connector
25	N	N/A	CFX20*2532S*N**** (See Table on Page 16, 17 for Options to Replace *)	N/A	Included with Connector	CFX26*2532P*N**** (See Table on Page 16, 17 for Options to Replace *)	N/A	Included with Connector
21 Pin Micro-D	N/A	N/A	See Table on Page 16, 17					
25	N	25-7	D38999/20*J9SN	M39029/114-628 (Size 8 Twinax) M39029/56-348 (Size 22)	Included with Connector	D38999/26*J9PN	M39029/113-625 (Size 8 Twinax) M39029/58-360 (Size 22)	Included with Connector
19	N	19-35	D38999/20*F35SN	M39029/56-348	Included with Connector	D38999/26*F35PN	M39029/58-360	Included with Connector
21	C	21-11	D38999/20*G11SC	M39029/75-416		Not Currently Supplied by TE	M39029/28-211	Included with Connector
17	N	17-6	D38999/20*E6SN	M39029/75-416		D38999/20*E6SA	M39029/28-211	Included with Connector
17	A	17-6	D38999/20*E6SA		Not Currently Supplied by TE	Not Currently Supplied by TE		Not Currently Supplied by TE

I/O INTERCONNECT

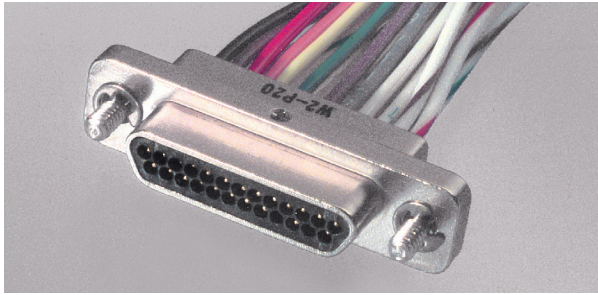

MICRO-D CONNECTORS

- Current rating – 3 amps max per contact
- Mating force maximum is 10 oz. (2.78N) times the number of contacts
- Low engaging force



CEELOK FAS-X CONNECTORS

- MIL-DTL-32546.1 compliant with zero bit error rate
- Proven AS39029 crimp contacts
- Uses 38999-style shell

FAST AND QUIET

- Gigabit or 10 Gigabit data delivery
- Excellent impedance matching and virtually no crosstalk
- Size 25 shell supports up to four Ethernet channels

HIGH PERFORMANCE

- Designed for use in rugged environments
- Ideal choice for 10G Ethernet, IEEE 1394, USB 2.0 and other high-speed protocols
- Shielding arrangement for superior signal integrity

CONVENIENT

- Fast field assembly, termination and repair
- Aluminum or composite shells with a range of finishes
- Install/repair using standard tools
- Range of inserts available for Size 25 shell for other connectivity needs

MICRO-D PART SELECTION

Cabled Connectors	MCKS	N1	B	21	
	MCKS Series	N1: Electroless Nickel C2: Yellow Chromate	B: No Hardware	21 Position	

PCB Connectors (Straight and Right Angle)	MCKS	N1	B	21	
	MCKS Series	N1: Electroless Nickel C2: Yellow Chromate	B: No Hardware P: Jackpost	21 Position	

Example PNs: **Cabled Connector:** MCKS-N1-B-21P8F1-18.0
PCB Connector: MCKS-N1-B-21SRT1

CeeLok FAS-X Part Numbering

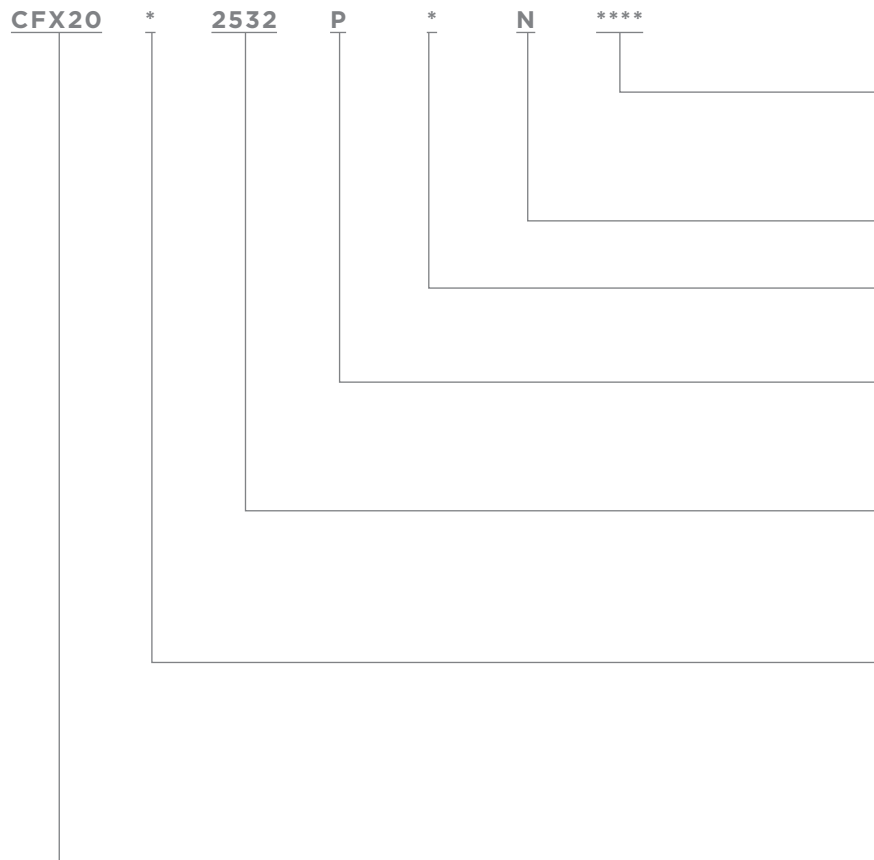

P		8F1		18
P: Pin	8: 28 AWG	F: 7 Strand per MIL-W-22759/11	1: All White Wire	Lead Length (18 in Minimum)
S: Socket			9: Solid Color Repeating per MIL-DTL-83513	

S		RT	1
P: Pin	RT: Right Angle Termination		1: .100" Leads
S: Socket	ST: Straight Termination		1A: .140" Leads
			1B: .172" Leads

MODIFICATIONS

- 0000** COTS Standard
- V000** QPL, Military PN Marking
- 1A** Without Backshell
- 1077** Without Grommet

KEYING POSITIONS

N, A, B, C, D, E (N is Normal)

TERMINATION TYPE

- Z** Crimp
- A** .232" Long Solder Tail (Contact TE for Other Tail Lengths)

CONTACT TYPE AND PLATING

- | | |
|---|--|
| P Pin, Selective Gold Plating | H Pin, High-Reliability Finish |
| S Socket, Selective Gold Plating | J Socket, High-Reliability Finish |
| F Pin, Full Gold Plating | A No Pin Contacts Included |
| G Socket, Full Gold Plating | B No Socket Contacts Included |

SHELL SIZE AND CONTACT ARRANGEMENT

- 1108** Single-Channel, Shell Size 11, 8 Size 22 Contacts
- 2532** Quad-Channel, Shell Size 25, 32 Size 22 Contacts
- 1104** Single-Channel Fiber Channel, Shell Size 11
- 2516** Quad-Channel Fiber Channel, Shell Size 25
- 2500** Quad-Channel, Shell Size 25, No Inserts or Contacts

CLASS (MATERIAL AND FINISH)

- M** Nickel-Plated Composite
- J** O. D. Cadmium-Plated Composite
- F** Nickel-Plated Aluminum
- W** O. D. Cadmium-Plated Aluminum
- A** Passivated Stainless Steel
- T** PTFE Nickel-Plated Aluminum
- Z** Black Zinc Nickel-Plated Aluminum

GENERAL IDENTIFIER

- | | |
|---|---|
| CFX20 Square Flange Receptacle (38999) | CFX34 Jam Nut Receptacle (Braid Clamp Backshell) |
| CFX21 In-Line Receptacle (38999) | CFX36 EMI/RFI Plug (Braid Clamp Backshell) |
| CFX24 Jam Nut Receptacle (38999) | CFX50 Square Flange Receptacle (Push-Pull Lanyard) (81703) |
| CFX26 EMI/RFI Plug (38999) | CFX54 Jam Nut Receptacle (Push-Pull Lanyard) (81703) |
| CFX30 Square Flange Receptacle (Braid Clamp Backshell) | CFX58 Plug (Push-Pull Lanyard) (81703) |
| | CFX59 Rack-and-Panel Plug (Push-Pull Lanyard) (81703) |

MULTI-MODE OPTICAL TERMINI

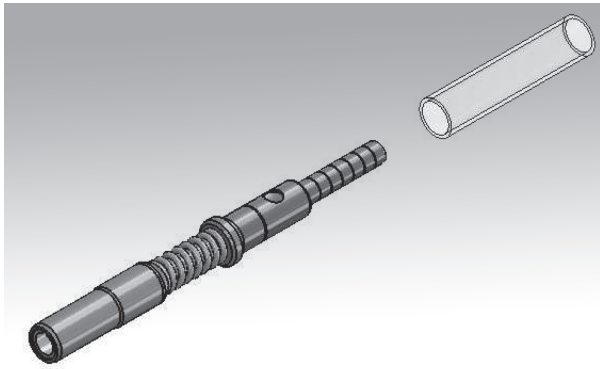

SINGLE-FIBER CERAMIC FERRULES

- MIL-PRF-29504/4 pin and /5 socket

MULTIFIBER ARRAYS

- MT multifiber ferrules

TE optical termini are designed to work with MIL-C-38999 SIII interconnects, and designed to MIL-T-29504/5 STYLE.

They use the most recent developments in precision ceramic ferrules and lightweight MIL-C-38999 Series III connector shell materials, designed to ensure the optical performance meets the requirements of high reliability optical systems. Compact spring loaded, precision optical contacts are individually insertable / removable for ease of assembly. Extensive testing has confirmed excellent performance under the most demanding environmental conditions.

SINGLE FIBER CERAMIC FERRULES

	MIL-PRF for Reference Only			
	TE Part Number	Bore Size	Style	TICC Number
Socket Contacts	457462-126-200	0.126 +0.001/-0	1	4311 4238
	457462-127-200	0.127 +0.001/-0	1	4046
	457462-232-150	0.232 +0.004/-0	1	N/A
	457462-283-250	0.283 +0.004/-0	1	N/A
Pin Contacts	457463-126-250	0.126 +0.001/-0	1	4302 4209
	457463-127-200	0.127 +0.001/-0	1	4040
	457463-232-200	0.232 +0.004/-0	1	N/A
	457463-283-250	0.283 +0.004/-0	1	N/A

COMPLETE SOLUTIONS FOR EMBEDDED COMPUTING

Count on TE for complete end-to-end solutions to enable high-performance computing. Our I/O solutions give you one of the widest ranges of choices for helping to increase speeds, going longer distances, and eliminating bandwidth bottlenecks.



38999 Connectors

- Withstands severe vibration, corrosive, and high-temperature environments
- High-vibration connector
- Over-travel system
- Anti-fire locking system
- More choice in shell sizes, materials, and options



CeeLok FAS-X Connectors

- One of the highest speed I/O connectors available
- Single-channel size 11 or four-channel size 25
- 38999 shells or ARINC 809
- Fast, easy assembly
- Composite or metal shell
- Lanyard-release option



Coax Connectors

- Meets MIL-PRF-39012 standard
- Uses industry standard crimp tools and processes
- 18 GHz



Optical Connectors

- Expanded beam, ceramic ferrule, and MT termini
- Single mode and multimode for any reach
- Compatibility with an extensive line of standard and optics-only connectors



High Speed Cable

- Material choices to match application requirements
- Shielded and unshielded
- Low-smoke, zero-halogen (LSZH) versions to help increase safety
- Configurations to support various Ethernet, Quadrx, IEEE 1394, USB, etc.



MULTIGIG

- Enhanced PCB wafer and contact design supports increased bandwidth
- Modular design enables numerous configurations
- Interface requirements allow backward compatibility with legacy VPX products
- Contact design utilizes quad redundant contacts for optimum performance in shock and vibration

Connect With Us

We make it easy to connect with our experts and are ready to provide all the support you need. Visit te.com/support to chat with a Product Information Specialist.

TE Connectivity
Aerospace, Defense & Marine

2900 Fulling Mill Road
Middletown, PA 17057

te.com/sosa

CeeLok FAS-X, TE, TE Connectivity, TE connectivity (logo), and EVERY CONNECTION COUNTS are trademarks owned or licensed by the TE Connectivity plc family of companies. Other product names, logos, and company names mentioned herein may be trademarks of their respective owners.

The information given herein, including drawings, illustrations and schematics which are intended for illustration purposes only, is believed to be reliable. However, TE Connectivity makes no warranties as to its accuracy or completeness and disclaims any liability in connection with its use. TE Connectivity's obligations shall only be as set forth in TE Connectivity's Standard Terms and Conditions of Sale for this product and in no case will TE Connectivity be liable for any incidental, indirect or consequential damages arising out of the sale, resale, use or misuse of the product. Users of TE Connectivity products should make their own evaluation to determine the suitability of each such product for the specific application.

©2025 TE Connectivity. All Rights Reserved.

2372550-1 11/25