



MxL86282S

Ethernet Switch

10-Port Ethernet Switch with Eight
2.5 Gigabit PHYs and Two 10 Gigabit
SerDes

MxL86282S

Data Sheet

Revision 1.3, 2025-09-26
Reference ID 621115

Legal Notice

The content of this document is furnished for informational use only, is subject to change without notice, and should not be construed as a commitment by MaxLinear, Inc. MaxLinear, Inc. assumes no responsibility or liability for any errors or inaccuracies that may appear in the informational content contained in this document. Complying with all applicable copyright laws is the responsibility of the user. Without limiting the rights under copyright, no part of this document may be reproduced into, stored in, or introduced into a retrieval system, or transmitted in any form or by any means (electronic, mechanical, photocopying, recording, or otherwise), or for any purpose, without the express written permission of MaxLinear, Inc.

EXCEPT AS OTHERWISE PROVIDED EXPRESSLY IN WRITING BY MAXLINEAR, AND TO THE MAXIMUM EXTENT PERMITTED BY LAW: (A) THE MAXLINEAR PRODUCTS ARE PROVIDED ON AN "AS IS" BASIS WITHOUT REPRESENTATIONS OR WARRANTIES OF ANY KIND, INCLUDING WITHOUT LIMITATION ANY IMPLIED OR STATUTORY WARRANTIES AND ANY WARRANTIES OF MERCHANTABILITY, FITNESS FOR A PARTICULAR PURPOSE, NON-INFRINGEMENT, OR TITLE; AND (B) MAXLINEAR DOES NOT GUARANTEE THAT THE PRODUCTS WILL BE FREE OF ERRORS OR DEFECTS. MAXLINEAR PRODUCTS SHOULD NOT BE USED IN ANY EMERGENCY, SECURITY, MILITARY, LIFE-SAVING, OR OTHER CRITICAL USE CASE WHERE A FAILURE OR MALFUNCTION COULD CAUSE PERSONAL INJURY OR DEATH, OR DAMAGE TO OR LOSS OF PROPERTY. USERS ASSUME ALL RISK FOR USING THE MAXLINEAR PRODUCTS IN SUCH USE CASE. CUSTOMERS AND USERS ARE SOLELY RESPONSIBLE FOR USING THEIR OWN SKILL AND JUDGMENT TO DETERMINE WHETHER MAXLINEAR PRODUCTS ARE SUITABLE FOR THE INTENDED USE CASE.

MaxLinear, Inc. may have patents, patent applications, trademarks, copyrights, or other intellectual property rights covering subject matter in this document. Except as expressly provided in any written license agreement from MaxLinear, Inc., the furnishing of this document does not give you any license to these patents, trademarks, copyrights, or other intellectual property.

MaxLinear, the MaxLinear logo, any other MaxLinear trademarks (including but not limited to MxL, Full-Spectrum Capture, FSC, AirPHY, Puma, AnyWAN, VectorBoost, MXL WARE, and Panther), are all property of MaxLinear, Inc. or one of MaxLinear's subsidiaries in the U.S.A. and other countries. All rights reserved.

All third-party marks and logos are trademarks™ or registered® trademarks of their respective holders/owners. Use of such marks does not imply any affiliation with, sponsorship or endorsement by the owners/holders of such trademarks. All references by MaxLinear to third party trademarks are intended to constitute nominative fair use under applicable trademark laws.

The URLs provided are for informational purposes only; they do not constitute an endorsement or an approval by MaxLinear of any of the products or services of the corporation or organization or individual. MaxLinear bears no responsibility for the accuracy, legality or content of the external site or for that of subsequent links. Contact the external site for answers to questions regarding its content.

© 2025 MaxLinear, Inc. All rights reserved.

MaxLinear, Inc.
5966 La Place Court, Suite 100
Carlsbad, CA 92008
Tel.: +1 (760) 692-0711
Fax: +1 (760) 444-8598
www.maxlinear.com

Revision History

Current: Revision 1.3, 2025-09-26

Previous: Revision 1.2, 2025-04-10

Page	Major changes since previous revision
125	Section 5.2 PHY-specific Management Registers: <ul style="list-style-type: none"> Removed Internal Test Modes CDIAG and ABIST (Register 0.31).
234	Section 6.4 Vendor Specific 1 Device Registers: <ul style="list-style-type: none"> Added USXGMII Status Register (Register 30.19).
286	Table 65 Product and Package Naming: <ul style="list-style-type: none"> Changed shipping format information and ordering part number.
Page	Major changes in Revision 1.2
284	Table 63 JEDEC Thermal Resistance Package Parameter - Compact 2-R Model Network: <ul style="list-style-type: none"> Updated table.

Third-Party Trademark and Registered Trademark Declarations

ANSI®	“ANSI”, the ANSI logo, and numerous other identifiers containing "ANSI" are registered trademarks, service marks, and accreditation marks of the American National Standards Institute (ANSI).
ARC®	ARC is a registered trademark of Synopsys, Inc. in the U.S. and/or other countries.
Cisco®	Cisco is a registered trademark or trademark of Cisco Systems, Inc. and/or its affiliates in the United States and certain other countries. A list of other Cisco marks is available at https://www.cisco.com/c/en/us/about/legal/trademarks.html .
IEEE®	“IEEE”, the IEEE logo, and other IEEE logos and titles are registered trademarks or service marks of The Institute of Electrical and Electronics Engineers, Incorporated.
IEEE 802.1™	IEEE 802.1 is a trademark of The Institute of Electrical and Electronics Engineers, Incorporated.
IEEE 802.3™	IEEE 802.3 is a trademark of The Institute of Electrical and Electronics Engineers, Incorporated.
ITU-T®	ITU-T is a registered trademark of the ITU, a specialized agency of the United Nations.
JEDEC®	JEDEC is a registered trademark of the JEDEC Solid State Technology Association.
Macronix®	Macronix, MXIC, MXIC logo, XtraROM, NBit and Macronix NBit are trademarks of Macronix International Co., Ltd.
Microsoft®	Microsoft is a registered trademark of Microsoft Corporation in the United States and/or other countries.
NXP®	NXP is a trademark of NXP B.V.
Philips®	The PHILIPS wordmark and shield emblem are registered trademarks of Koninklijke Philips N.V.
Winbond®	Winbond is a registered trademark of Winbond Electronics Corporation.

All other trademarks or registered trademarks are the property of their respective holders/owners.

Table of Contents

	Table of Contents	5
	List of Figures	9
	List of Tables	10
	Preface	12
1	Product Overview	13
1.1	Features	14
1.2	Applications	17
1.3	Block Diagram	18
2	External Signals	19
2.1	Logic Symbol	19
2.2	External Signal Description	20
2.2.1	Ball Diagram	20
2.2.2	Abbreviations	22
2.2.3	Input/Output Signals	23
2.2.3.1	Ethernet Twisted Pair Interface	23
2.2.3.2	USXGMII Interface	25
2.2.3.3	MDIO Interface	26
2.2.3.4	QSPI Interface	28
2.2.3.5	I ² C Interface	30
2.2.3.6	Reset Interface	31
2.2.3.7	LED/UART/JTAG Interface	32
2.2.3.8	Miscellaneous Signals	38
2.2.3.9	Power Supply for GPHY	41
2.2.3.10	Power Supply for USXGMII	43
2.2.3.11	Power Supply for TPI (AFE)	44
2.2.3.12	Ground	45
3	Functional Description	46
3.1	Power Supply, Clock, and Reset	46
3.1.1	Power Supply	46
3.1.2	Clock	46
3.1.3	Reset Generation	46
3.1.4	Power-On Sequence	46
3.1.5	Configuration by Pin Strapping	47
3.2	MDIO Slave Interface	49
3.3	Configuration via MDIO Management Interface	50
3.4	MDIO Master Interface	51
3.5	I ² C Master Interface	52
3.6	Quad Serial Peripheral Interface	53
3.6.1	Supported Flash Memory Devices	53
3.7	GPIO Mapping	55
3.8	Ethernet PHY Interface	57
3.8.1	Twisted Pair Interface	57
3.8.2	Transformerless Ethernet	57
3.8.3	Auto-Negotiation	58
3.8.4	Auto-Downspeed	58
3.8.5	Polarity Reversal Correction	58

Table of Contents

3.8.6	Auto-Crossover Correction	58
3.8.7	RJ45 Tab Up or Tab Down Configuration	59
3.8.8	Wake-on-LAN	60
3.9	Ethernet SerDes Interface	61
3.9.1	Ethernet SerDes Interface Configuration at Power On	61
3.10	LED Interface	62
3.10.1	LED	62
3.10.2	LED Configuration	62
3.10.3	LED Brightness Control	64
3.11	Power Management	65
3.11.1	Power States	65
3.11.2	RESET PWRUP	65
3.11.3	POWER DOWN State	65
3.11.4	SCAN (ANEG) State	66
3.11.5	PING (ANEG) State	66
3.11.6	Low-Power State	66
3.11.7	NORMAL State	70
3.11.8	Low Power IDLE State - Energy-Efficient Ethernet	71
3.12	Firmware Upgrade	72
3.13	Web-Smart Processor	73
3.14	Switch Fabric Functional Description	74
3.14.1	Overview	74
3.14.1.1	Packet Flow	74
3.14.1.2	Switch Fabric Control	75
3.14.2	Ethernet Bridging	76
3.14.2.1	Parsing	76
3.14.2.2	MAC Bridging Table	76
3.14.2.3	Layer 2 Security	76
3.14.2.4	Spanning Tree Protocol Support	77
3.14.2.5	Flow Control Function	77
3.14.2.6	Port Trunking Functions	77
3.14.3	VLAN Functions	79
3.14.3.1	VLAN Association	79
3.14.3.2	VLAN QinQ	79
3.14.3.3	Extended VLAN Tagging Operation	79
3.14.3.4	VLAN Filtering	80
3.14.3.5	VLAN Transparent Mode	80
3.14.3.6	Cross-VLAN Functionality	81
3.14.4	Multicast Forwarding Functions	82
3.14.4.1	Layer 2 Multicast Forwarding	82
3.14.4.2	Layer 3 Multicast Forwarding	82
3.14.4.3	IGMP and MLD Snooping	82
3.14.5	Quality of Service Functions	83
3.14.5.1	Class of Service Assignment	83
3.14.5.2	Remarking Function	83
3.14.5.3	Queue Mapping	84
3.14.5.4	Rate Metering	84
3.14.5.5	Rate Shaping	85
3.14.5.6	Queue Scheduling	85
3.14.5.7	Congestion Management	85
3.14.5.8	Egress Queue Congestion Notification	86

3.14.5.9	Storm Control	86
3.14.6	Flow Classification Function	88
3.14.7	Operation, Administration, and Management Functions	89
3.14.7.1	Monitoring Counters	89
3.14.7.2	Port Mirroring	89
3.14.7.3	Special Tag Functionality	90
3.14.7.4	Loop Detection	95
4	MDIO and MMD Register Interface Description	96
4.1	MDIO-specific Terminology	96
4.2	Register Naming and Numbering	97
4.2.1	Register Numbering	97
4.2.2	Register Naming	97
4.2.3	Examples	97
4.3	MMD Devices Present in MxL86282S	98
4.4	Responsibilities of the STA	99
4.5	MDIO Access Protocols to Read / Write Registers	100
5	PHY MDIO Registers Detailed Description	101
5.1	Standard Management Registers	102
5.1.1	Standard Management Register Descriptions	103
5.2	PHY-specific Management Registers	125
5.2.1	PHY-specific Management Register Descriptions	126
6	PHY MMD Registers Detailed Description	143
6.1	Standard PMAPMD Registers for MMD=0x01	144
6.1.1	PMAPMD Register Descriptions	146
6.2	Standard PCS Registers	185
6.2.1	PCS Register Descriptions	186
6.3	Standard Auto-Negotiation Registers for MMD=0x07	205
6.3.1	ANEG Register Descriptions	206
6.4	Vendor Specific 1 Device Registers	234
6.4.1	VSPEC1 Register Descriptions	235
6.5	Vendor Specific 2 Device Registers	253
6.5.1	VSPEC2 Register Descriptions	254
7	Electrical Characteristics	261
7.1	Absolute Maximum Ratings	261
7.2	Operating Range	263
7.3	Typical Power Consumption	264
7.4	Maximum Thermal Design Power	264
7.5	Maximum Current	264
7.6	DC Characteristics	266
7.6.1	Digital Interfaces	266
7.6.2	Twisted Pair Interface	266
7.6.3	Built-in Temperature Sensor	267
7.7	AC Characteristics	268
7.7.1	Power Up Sequence	268
7.7.2	Input Clock	270
7.7.3	Power Supply Rail Requirements	270
7.7.3.1	V _P AC and DC Power Supply Recommendations	271
7.7.3.2	V _{PH} AC and DC Power Supply Recommendations	272
7.7.4	MDIO Slave Interface	273
7.7.5	MDIO Master Interface	274

Table of Contents

7.7.6	Quad Serial Peripheral Interface (QSPI)	275
7.7.7	I ² C Interface	276
7.7.8	JTAG Interface	277
7.7.9	USXGMII Interface Characteristics	278
7.7.9.1	USXGMII Transmit Characteristics	278
7.7.9.2	USXGMII Receive Characteristics	278
7.7.10	Differential Reference Clock Interface	279
7.7.11	Crystal Specification	280
7.8	External Circuitry	281
7.8.1	Twisted-Pair Common-Mode Rejection and Termination Circuitry	281
7.8.2	Transformer (Magnetics)	282
7.8.3	RJ45 Plug	283
8	Package Outline	284
9	Product Ordering Information	286
	Literature References	287
	Standards References	287
	Terminology	288

List of Figures

Figure 1	MxL86282S Block Diagram	18
Figure 2	MxL86282S External Signal Overview	19
Figure 3	Ball Diagram for PG-FCLBGA-277 (Top View).	21
Figure 4	MDIO Slave	49
Figure 5	MDIO Access Timing	50
Figure 6	Twisted-Pair Interface of MxL86282S Including Transformer and RJ45 Plug	57
Figure 7	External Circuitry for the Transformerless Ethernet Application.	57
Figure 8	RJ45 Tab Up or Tab Down Configuration.	59
Figure 9	WoL Application Block Diagram	60
Figure 10	LED Connection Options to Ground or Power Supply	62
Figure 11	Connection of a Dual Color LED and Configuring Pin Strap Value	63
Figure 12	Connection of a Single Color LED and Configuring Pin Strap Value	63
Figure 13	LED Brightness Control by Controlling LED Output Enable/Disable	64
Figure 14	State Diagram for Power Down State Management.	65
Figure 15	Low Power Sequence.	67
Figure 16	EEE Low Power Idle Sequence	71
Figure 17	Packet Flow Diagram	74
Figure 18	Port Trunking Function	78
Figure 19	PCP/DSCP/DEI Remarking	83
Figure 20	Port Mirroring Examples – Ingress Monitoring	89
Figure 21	Port Mirroring Examples – Egress Monitoring	90
Figure 22	Port Redirection Examples – Egress Redirection.	90
Figure 23	Special Tag Location in the Frame	91
Figure 24	Input/Output Waveform for AC Tests	268
Figure 25	Timing Diagram for the Reset Sequence	269
Figure 26	DC and AC Characteristics for V_P Supply.	271
Figure 27	DC and AC Characteristics for V_{PH} Supply.	272
Figure 28	Timing Diagram for the MDIO Slave Interface	273
Figure 29	Timing Diagram for the MDIO Master Interface	274
Figure 30	QSPI Master Interface Timing	275
Figure 31	I ² C Timing.	276
Figure 32	Test Interface Timing	277
Figure 33	Twisted Pair Common-Mode Rejection and Termination Circuitry.	281
Figure 34	Schematic of an Ethernet Transformer Device.	282
Figure 35	PG-FCLBGA-277 12 mm x 12 mm Package Outline	285

List of Tables

Table 1	Ball Diagram Color Codes	20
Table 2	Abbreviations for Pin Type	22
Table 3	Abbreviations for Buffer Type	22
Table 4	Ethernet Twisted Pair Interface Signals	23
Table 5	USXGMII Interface Signals	25
Table 6	MDIO Management Interface Signals	26
Table 7	QSPI Management Interface Signals	28
Table 8	I ² C Management Interface Signals	30
Table 9	Reset Signals	31
Table 10	LED and Debug Interface Signals	32
Table 11	Miscellaneous Signals	38
Table 12	Power Supply Pins for GPHY	41
Table 13	Power Supply Pins for USXGMII	43
Table 14	Power Supply Pins for TPI (AFE)	44
Table 15	Ground Pins	45
Table 16	Pin Names Used for Pin Strapping	47
Table 17	Pin Strapping Configuration Description	47
Table 18	MDIO Ready Timing	50
Table 19	Supported Flash Memory Devices	53
Table 20	Flash Command and Timing	54
Table 21	GPIO Mapping	55
Table 22	Supported Twisted Pair Mappings on a Cat 5 or Better Cable	59
Table 23	Programming Sequence for the Wake-on-LAN Functionality	60
Table 24	Ethernet SerDes Interface Feature List	61
Table 25	Low Power State Entry and Exit Sequence	68
Table 26	Special Tag Ingress Format	91
Table 27	Traffic Class Map Coding	93
Table 28	Special Tag Egress Format	93
Table 29	MDIO/MMD Devices Present in MxL86282S	98
Table 30	Register Access Type	101
Table 31	Registers Overview- Standard Management Registers	102
Table 32	Registers Overview- PHY-specific Management Registers	125
Table 33	Register Access Type	143
Table 34	Registers Overview- Standard PMAPMD Registers	144
Table 35	Registers Overview- Standard PCS Registers	185
Table 36	Registers Overview- Standard Auto-Negotiation Registers	205
Table 37	Registers Overview- Vendor Specific 1 Device Registers	234
Table 38	Registers Overview- Vendor Specific 2 Device Registers	253
Table 39	Absolute Maximum Ratings	261
Table 40	Operating Range	263
Table 41	Typical Power Consumption	264
Table 42	Maximum Power Consumption	264
Table 43	Maximum Current Per Rail	265
Table 44	DC Characteristics of the GPIO Interfaces (VDDP = 3.3 V)	266
Table 45	DC Characteristics of the GPIO Interfaces (VDDP = 1.8 V)	266
Table 46	Temperature Sensor Characteristics	267
Table 47	Power Supply Timings	269
Table 48	AC Characteristics of Input Clock on XTAL1 Pin	270
Table 49	AC Characteristics of the Power Supply	270

List of Tables

Table 50	Timing Characteristics of the MDIO Slave Interface	273
Table 51	Timing Characteristics of the MDIO Master Interface	274
Table 52	QSPI Interface Timing Parameters	275
Table 53	I ² C Timing	276
Table 54	Test Interface Clock	277
Table 55	JTAG Timing	277
Table 56	Transmit Characteristics of the USXGMII	278
Table 57	Receive Characteristics of the USXGMII	278
Table 58	Reference Clock Output Characteristics	279
Table 59	Specification of the Crystal	280
Table 60	Electrical Characteristics for Common-Mode Rejection and Termination Circuitry	281
Table 61	Electrical Characteristics for Supported Transformers (Magnetics)	282
Table 62	Electrical Characteristics for Supported RJ45 Plugs	283
Table 63	JEDEC Thermal Resistance Package Parameter - Compact 2-R Model Network	284
Table 64	Stress Force Package Parameter	284
Table 65	Product and Package Naming	286

Preface

This Data Sheet describes the features and system architecture of the Ethernet Switch MxL86282S, which is a 10-Port Ethernet Switch with Eight 2.5 Gigabit PHYs and Two 10 Gigabit SerDes. In addition, the web-smart switch is capable of hosting a web-server.

Document Conventions

In the interest of brevity, this document uses short names to represent full product names.

MxL86282S Ethernet Switch MxL86282S

Document Information

This document's identifying information is:

Document Reference (Citation) Name

MxL86282S Ethernet Switch Data Sheet Rev. 1.3

File Name

621115_MxL86282S_DS_Rev1.3.pdf

Organization of this Document

- **Chapter 1, Product Overview**
This chapter provides an overview of the MxL86282S.
- **Chapter 2, External Signals**
This chapter provides a pinout of the MxL86282S device package.
- **Chapter 3, Functional Description**
This chapter provides the functional description for the MxL86282S.
- **Chapter 4, MDIO and MMD Register Interface Description**
This chapter describes the MDIO and MMD registers available to support the MxL86282S feature set.
- **Chapter 5, PHY MDIO Registers Detailed Description**
This chapter describes the fields and reset values of the MDIO registers.
- **Chapter 6, PHY MMD Registers Detailed Description**
This chapter describes the fields and reset values of the MMD registers.
- **Chapter 7, Electrical Characteristics**
This chapter provides the electrical characteristics for the MxL86282S.
- **Chapter 8, Package Outline**
This chapter provides a package outline for the MxL86282S.
- **Chapter 9, Product Ordering Information**
This chapter provides the product ordering details for the MxL86282S.
- **Standards References**

1 Product Overview

The MxL86282S device is a highly integrated, low power, non-blocking multi-port Ethernet Switch with two 10G Ethernet SerDes interfaces. It offers a cost-optimized solution well-suited for routers, switches, and home gateways. The MxL86282S has eight integrated Ethernet BASE-T PHYs which support four data rates: 2500, 1000, 100, and 10 Mbps.

On the Ethernet Twisted Pair Interface (TPI), the MxL86282S is compliant with the standards from IEEE 802.3 referenced in [6]:

- 2.5GBASE-T (IEEE 802.3 Clause 126, NBASE-T)
- 1000BASE-T (IEEE 802.3 Clause 40)
- 100BASE-TX (IEEE 802.3 Clause 25)
- 10BASE-Te (IEEE 802.3 Clause 14)

This interface supports the Energy-Efficient Ethernet (EEE) feature to reduce idle mode power consumption. Power saving at the system level is also possible with the wake-on-LAN feature. A low-EMI line driver with integrated termination facilitates the PCB design.

The two SerDes ports of the MxL86282S support up to 10 Gbps USXGMII [9] or XFI interface to connect to an external PHY, SFP, or the MAC of an external chip.

With reference to the Open System Interconnection (OSI) model, the MxL86282S implements eight layer 1 physical media access devices, a layer 2 switch, and an MDIO management interface.

The MxL86282S provides two Ethernet SerDes data interfaces, each configurable as single port 10G/5G/2.5G-USXGMII, SGMII+, SGMII, XFI/SFI/10G-KR, 5G-KR, 2500BASE-X, and 1000BASE-X to connect these options:

- SoC with single-port 10G USXGMII/XFI interface using an MDIO slave interface for management
- SFP cage with single-port 10G XFI interface using an I²C master interface for management
- 10G PHY with single-port 10G USXGMII/XFI interface using an MDIO master interface for management

Up to 1 MB embedded packet storage SRAM is integrated and 10 kB jumbo frames are supported. The MxL86282S integrates a 1K entry VLAN table for 802.1Q port-based, tag-based, and protocol-based VLAN operation. It also supports double VLAN tagging, insertion, removal, and translation. The MxL86282S features 16K VLAN-aware MAC addresses with 4-way hashing algorithm for address searching, auto-learning, and auto-aging.

A programmable packet parser and a powerful classification engine allow future-proof designs that enable various data traffic types. The MxL86282S supports IPv4 and IPv6 multicast forwarding, including IGMPv1/IGMPv2/IGMPv3 and MLDv1/MLDv2 snooping.

The MxL86282S features an advanced QoS architecture which prioritizes switch traffic for different classes of applications based on multiple fields of the packet. Multiple queues per port with strict or deficit weighted round robin scheduling and rate shaping are supported. It is possible to re-mark VLAN PCP and IP DSCP.

An ARC 400 MHz CPU is integrated in the MxL86282S to offer customer web management functions, including HTTP/HTTPS, secure boot, SSL, and dual image for firmware upgrade via webGUI.

The MxL86282S supports a standard MDIO management interface as defined in IEEE 802.3 Clause 22 and Clause 45 [6]. The MDIO serial interface is operable with a clock running up to 25 MHz. It allows a management entity (the external chip implementing the MAC) to access standard MDIO/MMD registers to control the MxL86282S's behavior, or to read the link status. The MxL86282S is also configurable via pin strapping.

The MxL86282S is capable of driving up to 24 LEDs (three per BASE-T port). Each LED is independently programmable to indicate the link speed and traffic activities. Several indication schemes are selectable.

External supplies of 0.8 V, 1.2 V, 1.8 V, and 3.3 V are required to power the MxL86282S device.

The MxL86282S uses a ball grid array package (type BGA 18 x18 matrix, size 12 mm x 12 mm).

1.1 Features

This section provides an overview of the features supported by the MxL86282S.

Communication Interfaces

- The eight Ethernet BASE-T interfaces support:
 - Ethernet modes and standards
2.5GBASE-T (IEEE 802.3, NBASE-T), 1000BASE-T (IEEE 802.3), 100BASE-TX (IEEE 802.3), and 10BASE-T_e (IEEE 802.3)
 - Ethernet twisted pair copper cable of category Cat5 or higher
 - Low EMI voltage mode line driver with integrated termination resistors
 - Transformerless Ethernet for backplane applications
 - Auto-Negotiation (ANEG) with extended next page support
 - Auto-MDIX and polarity correction
 - Auto-Downspeed (ADS)
 - 100BASE-TX EEE, 1000BASE-T EEE, 2.5GBASE-T EEE, and power down mode
 - Cable diagnostics: cable open/short detection and cable length estimation
 - Wake-on-LAN (WoL)
 - Jumbo frames of up to 10 kB
- Two Ethernet SerDes interfaces, where each interface supports:
 - 10G/5G/2.5G-USXGMII, SGMII+, SGMII, XFI/SFI, 10G-KR, 5G-KR, 2500BASE-X, and 1000BASE-X
 - IEEE 802.3-2012, IEEE 10GBASE-KR (10.3125 Gbps) Physical Layer electrical specifications
 - The PHY complies with all of the required features specified in the Cisco USXGMII Multiport Copper PHY Specification [10] and Cisco USXGMII Single-port Copper PHY Specification [11]
 - Back channel equalization, auto-negotiation, Forward Error Correction (FEC)
 - Clock and Data Recovery (CDR), no clock forwarding required
 - Clause 73 backplane auto-negotiation
 - Clause 37 auto-negotiation in SGMII and USXGMII modes
 - Clause 72 for 10G-base (K)R training
- The management interface supports the communication between the Station Manager (STA, per IEEE 802.3) and the MxL86282S using:
 - A Management Data Input/Output (MDIO) slave interface providing access to the standard registers in the MMD
 - An MDIO interface clock of up to 25 MHz
 - 3 MDIO message frame types as described in IEEE 802.3: Clause 22, Clause 22 Extended, and Clause 45 [6]
- The MDIO master interface controlling external devices supports:
 - Both clause 22 and clause 45
 - Automatic scanning of link status change of external devices. The MDIO addresses of the external devices are programmable.
 - The MxL86282S is able to access the external devices via an MDIO interface.
 - An MDIO interface clock of up to 50 MHz
- The Quad SPI master interface connecting to serial external Quad-SPI flash memory supports:
 - Programmable interface clock: maximum 101 MHz
 - Internal firmware code access from external Quad-SPI flash memory
 - Write access to the Quad-SPI flash memory
 - Different Quad-SPI flash memory sizes up to 512 MB
 - Secure firmware upgrade of the flash memory
- Two instances of the I²C master interface controlling external devices support these speed modes:
 - Standard mode (<100 Kbps)
 - Fast mode (<400 Kbps)
 - Fast mode plus (<1000 Kbps)

- High speed mode (<3.4 Mbps)
- The JTAG interface supports:
 - Boundary scan
 - Test and debug interface
 - Shared pins with GPIO functions
- The LED interface supports:
 - Programmable LED
 - Up to three LEDs per BASE-T port
 - Single and dual color LEDs
 - Connection of LED to ground or 3.3 V
 - Several LED indication schemes (link/activity, duplex/collision, and link speed)
 - Configuration of LED indication via MDIO registers
 - Control of LED brightness via software driver API
 - Alternative configuration of LED pins as GPIO for custom indication
- Supports two external interrupts:
 - Configurable as output to an external controller
 - Configurable as input from external device(s)
 - Configurable edge, level, and polarity

On-Chip Web-Smart Processor (WSP)

- An ARC EM4 subsystem:
 - Integrated micro-controller
 - 64 KB of instruction cache
 - Host a web-server
 - HTTP/HTTPS
 - Secure Boot
 - SSL
 - Dual image for firmware upgrade in smart mode

Clocking and Timing Features

- The input reference clock options are:
 - 25 MHz crystal operation
 - 25 MHz direct from an external oscillator
 - An external CML/LVPECL reference clock operating at 50 MHz
- The output reference clock options are two pairs of differential clocks at 50 MHz, 156.25 MHz, and the same frequency as the input reference clock.

Ethernet MACs

- Eight Ethernet MACs for each BASE-T port, complying with IEEE 802.3:
 - Quad rate, that is, 10 Mbps, 100 Mbps, 1000 Mbps, or 2.5 Gbps operation speed for internal PHY
 - Half-duplex operation mode for 10 Mbps and 100 Mbps
 - Full-duplex operation mode for all speeds
- Two Ethernet MACs for each Ethernet SerDes interface, complying with IEEE 802.3:
 - Multiple rate at 10 Mbps, 100 Mbps, 1000 Mbps, 2.5 Gbps, 5 Gbps, or 10 Gbps operation speed for external PHY
 - Full-duplex operation mode for all speeds
- Enhanced frame size support (Jumbo frames, programmable limit up to 10 Kbyte)
- 802.3X flow control (pause frame) and 802.1Qbb flow control (PFC pause frame) in full-duplex mode. Backpressure (forced collisions) in half-duplex mode.
- Frame padding on egress traffic

- Minimum and maximum frame length check
- Frame Check Sequence (FCS) verification and stripping
- FCS generation and insertion/replacement
- Low Power Idle (LPI) mode as defined by IEEE 802.3 EEE

Pseudo MAC

- Carrying traffic to/from the integrated CPU
- FCS stripping, replacement, or insertion on the traffic to the integrated CPU
- FCS verification and/or stripping for traffic from the integrated CPU

Packet Processing

- L2 bridging
 - 16K entry VLAN-aware MAC address table
 - Shared and independent VLAN learning
 - Layer 2 security: IEEE 802.1X port authentication, MAC address filtering, port locking and spoofing detection, MAC address limiting, and broadcast storm control
 - Multiple spanning tree protocol
 - MAC in MAC tunneling (802.1ah), 256 tunnels
- L3 multicast forwarding at virtual-interface level
 - 1K entry VLAN aware IP multicast group table
 - Any Source Multicast (ASM) and Source Specific Multicast (SSM)
 - IPv4 IGMPv1/IGMPv2/IGMPv3 and IPv6 MLDv1/MLDv2 with software/firmware involvement
- VLAN classification
 - 802.1Q, 802.1Q QinQ, 802.1Qbg
 - 1K entry VLAN filtering
 - 1K entry extended VLAN tagging operation with sophisticated single tag and double tag VLAN mapping and translation
 - Private VLAN
- Traffic flow classification (ACL)
 - Programmable packet parsing
 - 512 entry traffic flow classification table
 - 32 concurrent keys with 1k bits in each entry
 - Support bit mask and range for some of the keys. Keys include the source port information, packet length, and multiple L2/L3/L4/L4+ packet fields.
 - Multiple concurrent policy actions in each entry
 - Destination port(s) assignment (including discard option), port filtering, traffic class assignment, traffic meter assignment, extended VLAN tagging operation assignment, MAC in MAC tunnel assignment, flow counter assignment, OAM handling assignment, cross VLAN policy, cross state policy, color assignment, Link Aggregation Group (LAG) assignment, L2 MAC address learning policy, and interrupt policy
- Advanced QoS
 - Up to 1 MB packet buffer
 - Total 128 priority queues, up to eight priority queues per port
 - Flexible traffic class assignment
 - Flexible priority marking and re-marking
 - Flexible color marking and re-marking
 - Traffic metering on ingress and/or egress traffic
 - srTCM and trTCM, 128 meters
 - Per port and per queue shaping
 - Strict priority and DWRR scheduling
- Operation, Maintenance, and Management
 - Packets and bytes counters per MAC, per port, per virtual interface, and per traffic flow

- Packet mirroring (ingress and egress mirroring to a designated port)
- Loop detection support with software/firmware involvement
- Loop-back support
- IEEE 802.1ag and ITU-T Y.1731 Ethernet OAM delay and loss measurement hardware support
- LAG support
 - 32 groups, up to 64 ports or virtual interfaces in a LAG

Other Features

- Temperature Sensor (warning, interrupt, reset, and auto-downspeed)

Power Supply

- 3.3 V, 1.8 V, 1.2 V, and 0.8 V external power sources

1.2 Applications

This section lists the supported modes of operation.

- Smart mode, whereby running a web-server is supported, and is configured via a web interface [3]. Pre-configuration of the features in the Flash Configuration Area (FCA) is also supported. The FCA is an area in the flash memory which can be used to realize a limited static functionality set that differs from the default configuration. The FCA is described in [2]. This mode is the main application (web-smart) of the MxL86282S. Refer to [3] for information on using the MaxLinear-provided web-server. Refer to [4] for information on customizing the web-server.
- Unmanaged mode, whereby no reconfiguration during runtime is necessary. MxL86282S-based devices work out of the box with their basic or default feature set. FCA must be used to change the default configuration. This mode is also supported in Ethernet Switch MxL86282C. Refer to [1] for more information about the capabilities of the MxL86282C.
- MDIO-managed mode, whereby the configuration of a lot of features is offered by means of an API via the slave MDIO interface. Contact MaxLinear for access to the API documentation. Pre-configuration of the features in the FCA is also supported. This mode is also supported in Ethernet Switch MxL86282C. Refer to [1] for more information about the capabilities of the MxL86282C.

1.3 Block Diagram

Figure 1 shows the block diagram of the MxL86282S. The main interfaces are:

- Data interface to a SFP/PHY/SoC/MAC processor, using USXGMII/XFI
- Slave control interface driven by a SoC processor, using MDIO slave
- Master control interface driven to a PHY, using MDIO master
- Master control interface driven to a SFP, using I²C master
- Interrupt signal MDINT allowing the MxL86282S to notify the external processor about a change of status
- LED control
- Twisted pair interfaces (TPI)
- Master Quad Serial Peripheral Interface (QSPI) interface

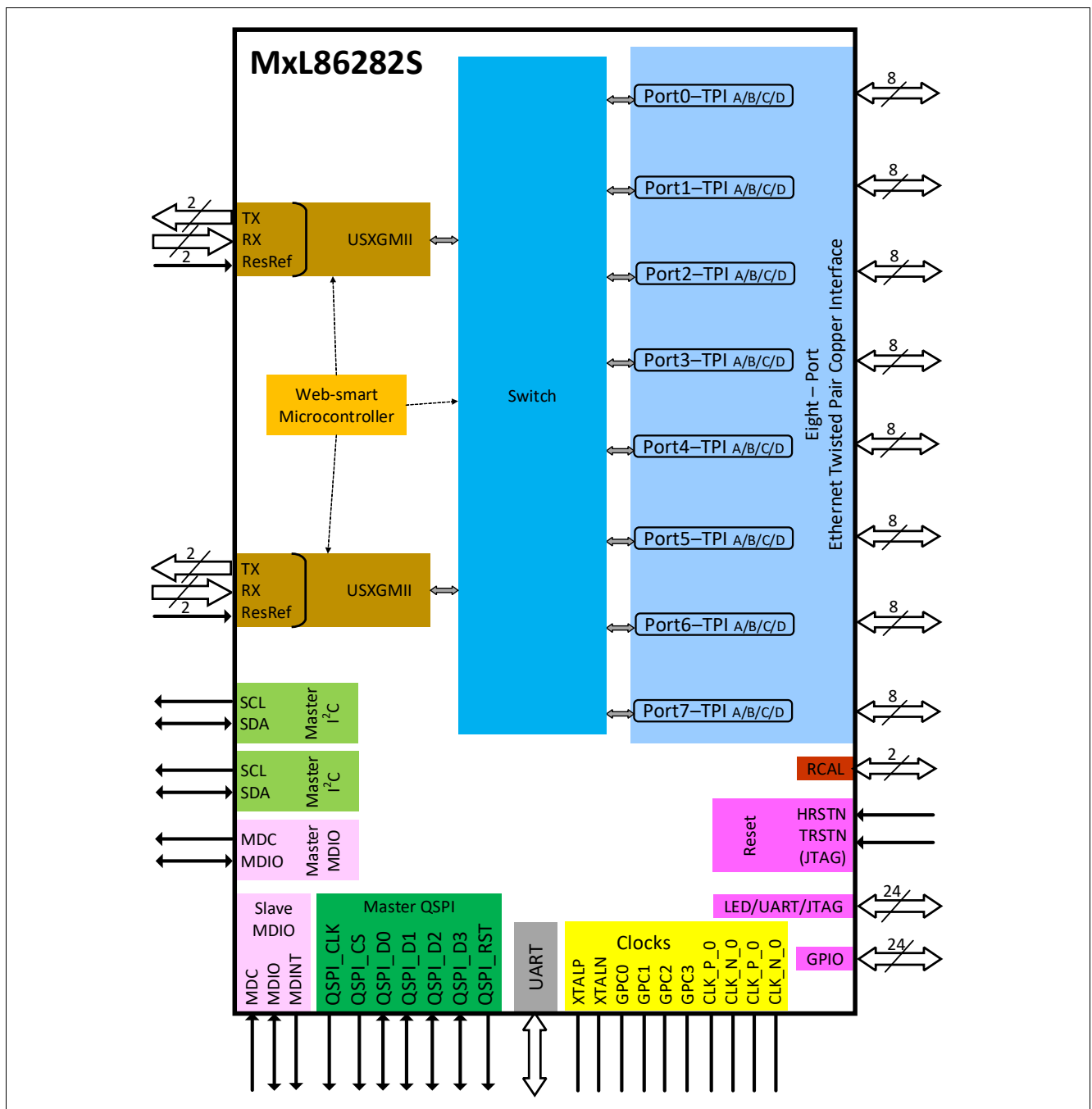

Figure 1 MxL86282S Block Diagram

2 External Signals

This chapter describes the signal mapping to the package.

2.1 Logic Symbol

Figure 2 gives an overview of the device's external interfaces.

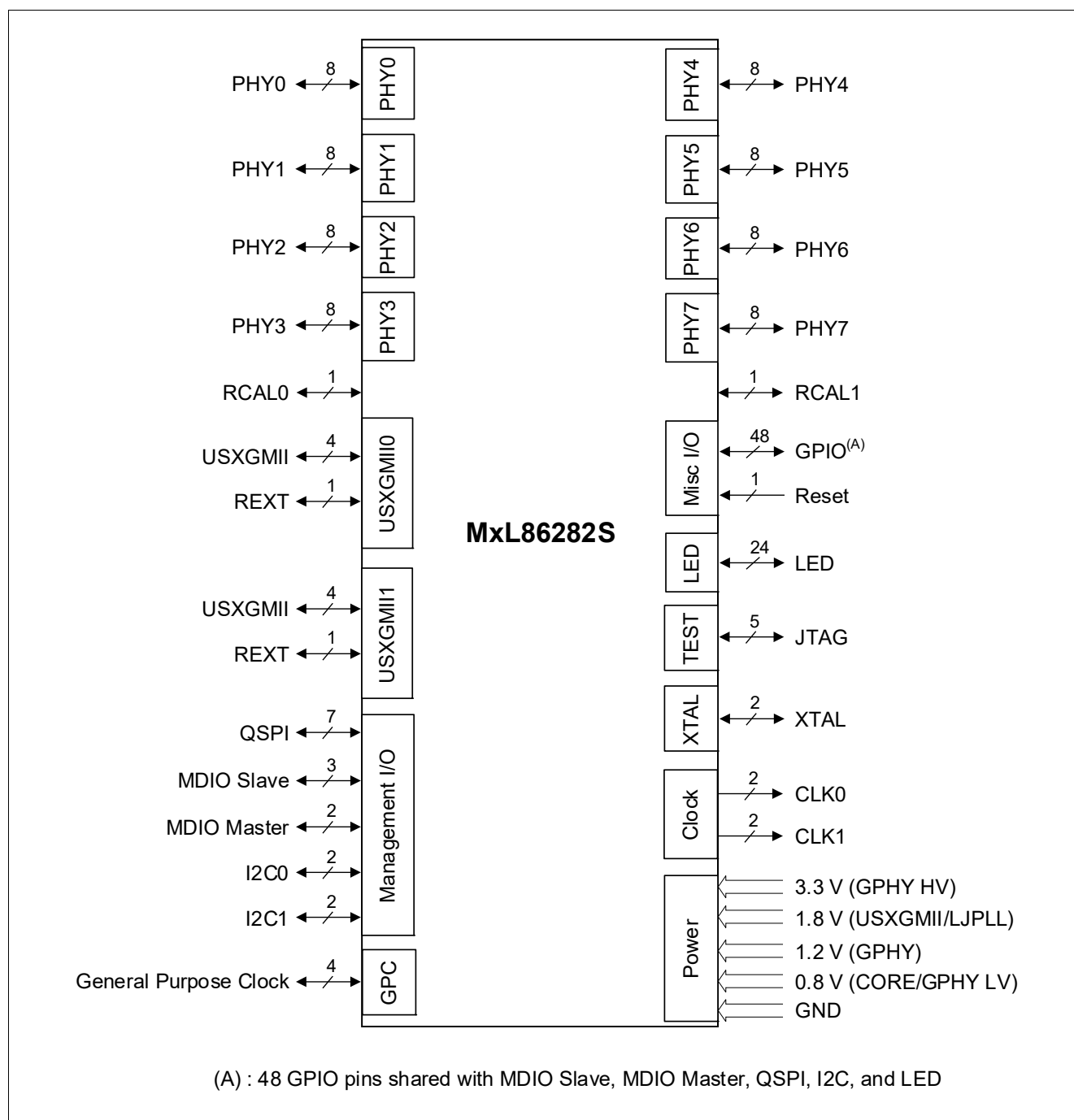

Figure 2 MxL86282S External Signal Overview

2.2 External Signal Description

This section provides the ball diagram, abbreviations for pin types and buffer types, and the table of input and output signals.

2.2.1 Ball Diagram

Figure 3 shows the ball diagram. **Table 1** lists the ball diagram color codes.

Table 1 Ball Diagram Color Codes

Color	Description
White	Unpopulated Balls
Red	Power
Light Red	USXGMII Power
Orange	MDIO, I ² C Signals
Grey	Ground
Blue	TPI-related Signals
Pink	QSPI, Reset Signals
Yellow	USXGMI Signals
Light Green	Clock, GPIO Signals
Light Blue	LED, JTAG Signals

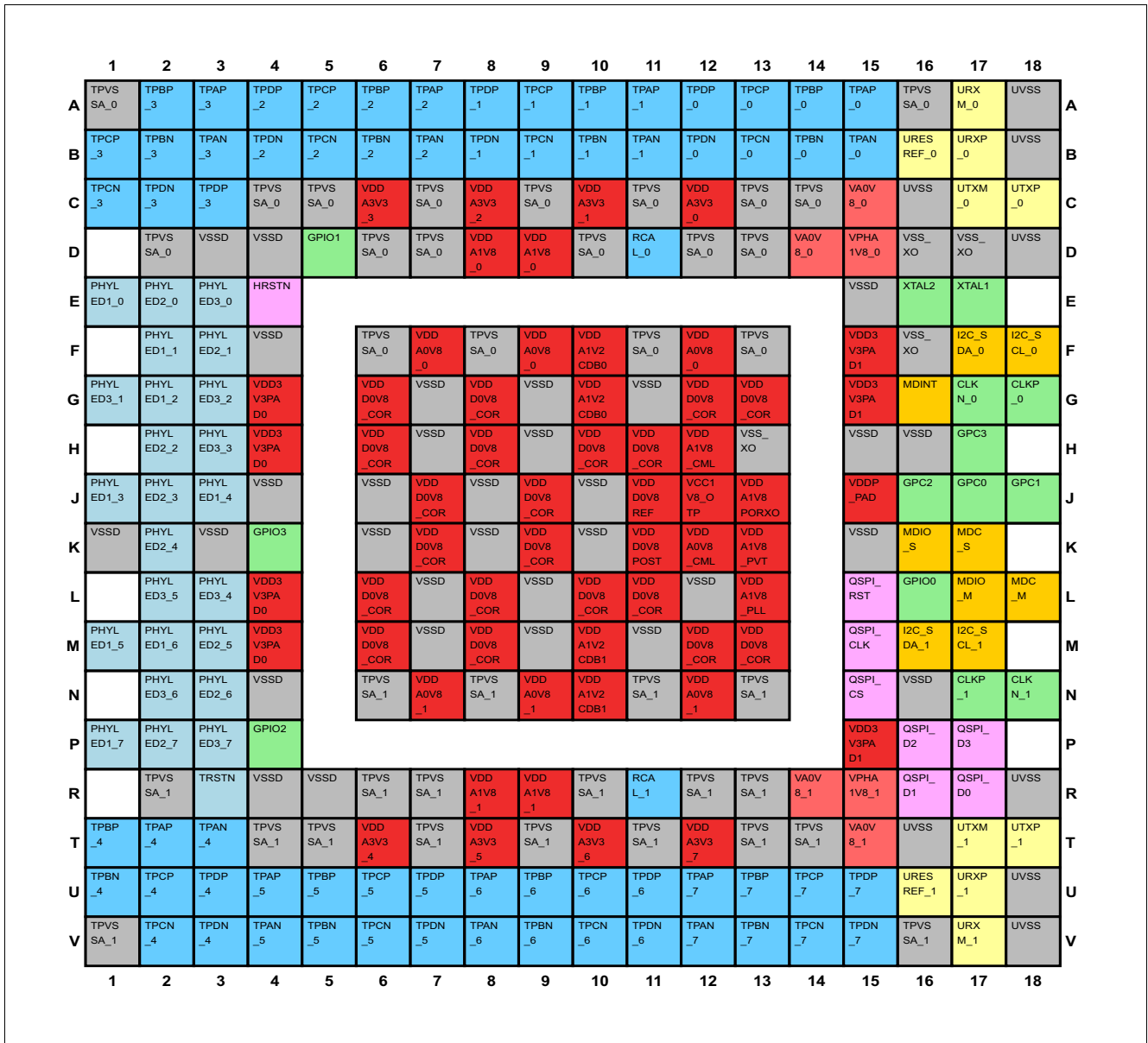

Figure 3 Ball Diagram for PG-FCLBGA-277 (Top View)

2.2.2 Abbreviations

Table 2 and **Table 3** summarize the abbreviations used in the signal tables.

Table 2 Abbreviations for Pin Type

Abbreviations	Description
I	Input-only, digital levels
O	Output-only, digital levels
I/O	Bidirectional input/output signal, digital levels
Prg	Bidirectional pin, programmable to operate either as input or output, digital levels
AI	Input-only, analog levels
AO	Output-only, analog levels
AI/AO	Bidirectional, analog levels
PWR	Power
GND	Ground

Table 3 Abbreviations for Buffer Type

Abbreviations	Description
A	Analog characteristics, see the AC/DC specification for more information.
Prg	Programmable (open-drain/push-pull, pull-up/pull-down characteristic are programmable)
PU	Pull up (internal, weak)

2.2.3 Input/Output Signals

Table 4 to Table 15 provide a detailed description of all the pins.

2.2.3.1 Ethernet Twisted Pair Interface

Unused TPI signals must be unconnected.

Table 4 Ethernet Twisted Pair Interface Signals

Ball No.	Name	Pin Type	Buffer Type	Function
Ethernet Port Twisted Pair Interface				
A15	TPAP_0	AI/AO	A	Port 0 Transmit/Receive Positive/Negative
B15	TPAN_0	AI/AO	A	
A14	TPBP_0	AI/AO	A	
B14	TPBN_0	AI/AO	A	
A13	TPCP_0	AI/AO	A	
B13	TPCN_0	AI/AO	A	
A12	TPDP_0	AI/AO	A	
B12	TPDN_0	AI/AO	A	
A11	TPAP_1	AI/AO	A	Port 1 Transmit/Receive Positive/Negative
B11	TPAN_1	AI/AO	A	
A10	TPBP_1	AI/AO	A	
B10	TPBN_1	AI/AO	A	
A9	TPCP_1	AI/AO	A	
B9	TPCN_1	AI/AO	A	
A8	TPDP_1	AI/AO	A	
B8	TPDN_1	AI/AO	A	
A7	TPAP_2	AI/AO	A	Port 2 Transmit/Receive Positive/Negative
B7	TPAN_2	AI/AO	A	
A6	TPBP_2	AI/AO	A	
B6	TPBN_2	AI/AO	A	
A5	TPCP_2	AI/AO	A	
B5	TPCN_2	AI/AO	A	
A4	TPDP_2	AI/AO	A	
B4	TPDN_2	AI/AO	A	
A3	TPAP_3	AI/AO	A	Port 3 Transmit/Receive Positive/Negative
B3	TPAN_3	AI/AO	A	
A2	TPBP_3	AI/AO	A	
B2	TPBN_3	AI/AO	A	
B1	TPCP_3	AI/AO	A	
C1	TPCN_3	AI/AO	A	
C3	TPDP_3	AI/AO	A	

Table 4 Ethernet Twisted Pair Interface Signals (cont'd)

Ball No.	Name	Pin Type	Buffer Type	Function
C2	TPDN_3	AI/AO	A	
T2	TPAP_4	AI/AO	A	Port 4 Transmit/Receive Positive/Negative
T3	TPAN_4	AI/AO	A	
T1	TPBP_4	AI/AO	A	
U1	TPBN_4	AI/AO	A	
U2	TPCP_4	AI/AO	A	
V2	TPCN_4	AI/AO	A	
U3	TPDP_4	AI/AO	A	
V3	TPDN_4	AI/AO	A	
U4	TPAP_5	AI/AO	A	Port 5 Transmit/Receive Positive/Negative
V4	TPAN_5	AI/AO	A	
U5	TPBP_5	AI/AO	A	
V5	TPBN_5	AI/AO	A	
U6	TPCP_5	AI/AO	A	
V6	TPCN_5	AI/AO	A	
U7	TPDP_5	AI/AO	A	
V7	TPDN_5	AI/AO	A	
U8	TPAP_6	AI/AO	A	Port 6 Transmit/Receive Positive/Negative
V8	TPAN_6	AI/AO	A	
U9	TPBP_6	AI/AO	A	
V9	TPBN_6	AI/AO	A	
U10	TPCP_6	AI/AO	A	
V10	TPCN_6	AI/AO	A	
U11	TPDP_6	AI/AO	A	
V11	TPDN_6	AI/AO	A	
U12	TPAP_7	AI/AO	A	Port 7 Transmit/Receive Positive/Negative
V12	TPAN_7	AI/AO	A	
U13	TPBP_7	AI/AO	A	
V13	TPBN_7	AI/AO	A	
U14	TPCP_7	AI/AO	A	
V14	TPCN_7	AI/AO	A	
U15	TPDP_7	AI/AO	A	
V15	TPDN_7	AI/AO	A	
Ethernet Port Test Point				
D11	RCAL_0	AI/AO	A	Test Point for GPHY Ethernet Ports 0 to 3 Test point, do not connect.
R11	RCAL_1	AI/AO	A	Test Point for GPHY Ethernet Ports 4 to 7 Test point, do not connect.

2.2.3.2 USXGMII Interface

The balls listed in [Table 5](#) also apply for XFI and USXGMII.

Table 5 USXGMII Interface Signals

Ball No.	Name	Pin Type	Buffer Type	Function
B17	URXP_0	AI	A	Differential USXGMII 0 Data Input Pair These are the negative and positive signals of the differential input pair of the USXGMII SerDes interface. Due to the integrated CDR, no external transmission peer source-synchronous clock is required for USXGMII. These pins must be AC-coupled.
A17	URXM_0	AI	A	
C18	UTXP_0	AO	A	Differential USXGMII 0 Data Output Pair These are the negative and positive signals of the differential output pair of the USXGMII SerDes interface. Due to the integrated CDR, no external transmission peer source-synchronous clock is required for USXGMII. These pins must be AC-coupled.
C17	UTXM_0	AO	A	
B16	URESREF_0	AI/AO	A	External USXGMII Tuning Resistor 0 Attach a 200 Ω ($\pm 1\%$) resistor-to-ground on the board.
U17	URXP_1	AI	A	Differential USXGMII 1 Data Input Pair These are the negative and positive signals of of the differential input pair of the USXGMII SerDes interface. Due to the integrated CDR, no external transmission peer source-synchronous clock is required for USXGMII. These pins must be AC-coupled.
V17	URXM_1	AI	A	
T18	UTXP_1	AO	A	Differential USXGMII 1 Data Output Pair These are the negative and positive signals of the differential output pair of the USXGMII SerDes interface. Due to the integrated CDR, no external transmission peer source-synchronous clock is required for USXGMII. These pins must be AC-coupled.
T17	UTXM_1	AO	A	
U16	URESREF_1	AI/AO	A	External USXGMII Tuning Resistor 1 Attach a 200 Ω ($\pm 1\%$) resistor-to-ground on the board.

2.2.3.3 MDIO Interface

Table 6 MDIO Management Interface Signals

Ball No.	Name	Pin Type	Buffer Type	Function
MDIO Slave Interface				
G16	MDINT	O	Prg	MDIO Interrupt from Any GPHY The interrupt interrupts an external block such as a higher-level management entity or a device controller of an SoC, on detection of certain events and states inside the GPHY device. Voltage Domain: 1.8 V / 3.3 V
	GPIO4	Prg		General Purpose IO 4 Either input or output mode. The output characteristic is either open drain or push-pull. Voltage Domain: 1.8 V / 3.3 V
K17	MDC_S	I	Prg	MDIO Slave Clock The external controller provides the serial clock of up to 25 MHz on this input. Voltage Domain: 1.8 V / 3.3 V
	GPIO5	Prg		General Purpose IO 5 Either input or output mode. The output characteristic is either open drain or push-pull. Voltage Domain: 1.8 V / 3.3 V
K16	MDIO_S	I/O	Prg	MDIO Slave Data Input/Output The external controller uses this signal to address internal registers and to transfer data to and from the internal registers. Voltage Domain: 1.8 V / 3.3 V
	GPIO6	Prg		General Purpose IO 6 Either input or output mode. The output characteristic is either open drain or push-pull. Voltage Domain: 1.8 V / 3.3 V
MDIO Master Interface				
L18	MDC_M	O	Prg	MDIO Master Clock The device provides the serial clock of up to 50 MHz on this output. Voltage Domain: 1.8 V / 3.3 V
	GPIO7	Prg		General Purpose IO 7 Either input or output mode. The output characteristic is either open drain or push-pull. Voltage Domain: 1.8 V / 3.3 V

Table 6 MDIO Management Interface Signals (cont'd)

Ball No.	Name	Pin Type	Buffer Type	Function
L17	MDIO_M	I/O	Prg	MDIO Master Data Input/Output The device uses this signal to address external registers and to transfer data to and from the external registers. Voltage Domain: 1.8 V / 3.3 V
	GPIO8	Prg		General Purpose IO 8 Either input or output mode. The output characteristic is either open drain or push-pull. Voltage Domain: 1.8 V / 3.3 V

2.2.3.4 QSPI Interface

Table 7 QSPI Management Interface Signals

Ball No.	Name	Pin Type	Buffer Type	Function
R17	QSPI_D0	I/O	Prg	QSPI Data 0 QSPI interface data 0 Voltage Domain: 3.3 V
	GPIO9	Prg		General Purpose IO 9 Either input or output mode. The output characteristic is either open drain or push-pull. Voltage Domain: 3.3 V
R16	QSPI_D1	I/O	Prg	QSPI Data 1 QSPI interface data 1 Voltage Domain: 3.3 V
	GPIO10	Prg		General Purpose IO 10 Either input or output mode. The output characteristic is either open drain or push-pull. Voltage Domain: 3.3 V
P16	QSPI_D2	I/O	Prg	QSPI Data 2 QSPI interface data 2 Voltage Domain: 3.3 V
	GPIO11	Prg		General Purpose IO 11 Either input or output mode. The output characteristic is either open drain or push-pull. Voltage Domain: 3.3 V
P17	QSPI_D3	I/O	Prg	QSPI Data 3 QSPI interface data 3 Voltage Domain: 3.3 V
	GPIO12	Prg		General Purpose IO 12 Either input or output mode. The output characteristic is either open drain or push-pull. Voltage Domain: 3.3 V
M15	QSPI_CLK	O	Prg	QSPI Clock QSPI interface clock output Voltage Domain: 3.3 V
	GPIO13	Prg		General Purpose IO 13 Either input or output mode. The output characteristic is either open drain or push-pull. Voltage Domain: 3.3 V

Table 7 QSPI Management Interface Signals (cont'd)

Ball No.	Name	Pin Type	Buffer Type	Function
N15	QSPI_CS	O	Prg	QSPI Chip Select QSPI interface chip select Voltage Domain: 3.3 V
	GPIO14	Prg		General Purpose IO 14 Either input or output mode. The output characteristic is either open drain or push-pull. Voltage Domain: 3.3 V
L15	QSPI_RST	O	Prg	QSPI Reset QSPI Reset Voltage Domain: 3.3 V
	GPIO15	Prg		General Purpose IO 15 Either input or output mode. The output characteristic is either open drain or push-pull. Voltage Domain: 3.3 V

2.2.3.5 I²C Interface

Table 8 I²C Management Interface Signals

Ball No.	Name	Pin Type	Buffer Type	Function
F18	I2C_SCL_0	O	Prg	I²C 0 Clock Output I ² C 0 interface clock output Voltage Domain: 3.3 V
	GPIO16	Prg		General Purpose IO 16 Either input or output mode. The output characteristic is either open drain or push-pull. Voltage Domain: 3.3 V
F17	I2C_SDA_0	I/O	Prg	I²C 0 Data I ² C 0 interface data Voltage Domain: 3.3 V
	GPIO17	Prg		General Purpose IO 17 Either input or output mode. The output characteristic is either open drain or push-pull. Voltage Domain: 3.3 V
M17	I2C_SCL_1	O	Prg	I²C 1 Clock Output I ² C 1 interface clock output Voltage Domain: 3.3 V
	GPIO18	Prg		General Purpose IO 18 Either input or output mode. The output characteristic is either open drain or push-pull. Voltage Domain: 3.3 V
M16	I2C_SDA_1	I/O	Prg	I²C 1 Data I ² C 1 interface data Voltage Domain: 3.3 V
	GPIO19	Prg		General Purpose IO 19 Either input or output mode. The output characteristic is either open drain or push-pull. Voltage Domain: 3.3 V

2.2.3.6 Reset Interface

Table 9 Reset Signals

Ball No.	Name	Pin Type	Buffer Type	Function
E4	HRSTN	I	PU	Hardware Reset Asynchronous active low device reset Voltage Domain: 3.3 V

2.2.3.7 LED/UART/JTAG Interface
Table 10 LED and Debug Interface Signals

Ball No.	Name	Pin Type	Buffer Type	Function
LED Signals				
E1	PHYLED1_0	I/O		GPHY LED1 for Port 0 LED control output, drives single-color or dual color LEDs. Voltage Domain: 3.3 V
	GPIO20	Prg	Prg	General Purpose IO 20 Either input or output mode. The output characteristic is either open drain or push-pull. Voltage Domain: 3.3 V
	FW_UTXD	O		Firmware UART Data Output Firmware UART interface data output Voltage Domain: 3.3 V
E2	PHYLED2_0	I/O		GPHY LED2 for Port 0 LED control output, drives single-color or dual color LEDs. Voltage Domain: 3.3 V
	GPIO21	Prg	Prg	General Purpose IO 21 Either input or output mode. The output characteristic is either open drain or push-pull. Voltage Domain: 3.3 V
	FW_URXD	I		Firmware UART Data Input Firmware UART interface data input Voltage Domain: 3.3 V
E3	PHYLED3_0	I/O		GPHY LED3 for Port 0 LED control output, drives single-color or dual color LEDs. Voltage Domain: 3.3 V
	GPIO22	Prg	Prg	General Purpose IO 22 Either input or output mode. The output characteristic is either open drain or push-pull. Voltage Domain: 3.3 V
F2	PHYLED1_1	I/O		GPHY LED1 for Port 1 LED control output, drives single-color or dual color LEDs. Voltage Domain: 3.3 V
	GPIO23	Prg	Prg	General Purpose IO 23 Either input or output mode. The output characteristic is either open drain or push-pull. Voltage Domain: 3.3 V
	FW_UTXD	O		Firmware UART Data Output Firmware UART interface data output Voltage Domain: 3.3 V

Table 10 LED and Debug Interface Signals (cont'd)

Ball No.	Name	Pin Type	Buffer Type	Function
F3	PHYLED2_1	I/O		GPHY LED2 for Port 1 LED control output, drives single-color or dual color LEDs. Voltage Domain: 3.3 V
	GPIO24	Prg	Prg	General Purpose IO 24 Either input or output mode. The output characteristic is either open drain or push-pull. Voltage Domain: 3.3 V
G1	PHYLED3_1	I/O		GPHY LED3 for Port 1 LED control output, drives single-color or dual color LEDs. Voltage Domain: 3.3 V
	GPIO25	Prg	Prg	General Purpose IO 25 Either input or output mode. The output characteristic is either open drain or push-pull. Voltage Domain: 3.3 V
G2	PHYLED1_2	I/O		GPHY LED1 for Port 2 LED control output, drives single-color or dual color LEDs. Voltage Domain: 3.3 V
	GPIO26	Prg	Prg	General Purpose IO 26 Either input or output mode. The output characteristic is either open drain or push-pull. Voltage Domain: 3.3 V
	TDI	I		JTAG Serial Test Data Input Voltage Domain: 3.3 V <i>Note: No external pull-up required.</i>
	FW_UTXD	O		Firmware UART Data Output Firmware UART interface data output Voltage Domain: 3.3 V
H2	PHYLED2_2	I/O		GPHY LED2 for Port 2 LED control output, drives single-color or dual color LEDs. Voltage Domain: 3.3 V
	GPIO27	Prg	Prg	General Purpose IO 27 Either input or output mode. The output characteristic is either open drain or push-pull. Voltage Domain: 3.3 V
	TMS	I		JTAG Test Mode Select Voltage Domain: 3.3 V <i>Note: No external pull-up required.</i>
G3	PHYLED3_2	I/O		GPHY LED3 for Port 2 LED control output, drives single-color or dual color LEDs. Voltage Domain: 3.3 V
	GPIO28	Prg	Prg	General Purpose IO 28 Either input or output mode. The output characteristic is either open drain or push-pull. Voltage Domain: 3.3 V

Table 10 LED and Debug Interface Signals (cont'd)

Ball No.	Name	Pin Type	Buffer Type	Function
J1	PHYLED1_3	I/O		GPHY LED1 for Port 3 LED control output, drives single-color or dual color LEDs. Voltage Domain: 3.3 V
	GPIO29	Prg	Prg	General Purpose IO 29 Either input or output mode. The output characteristic is either open drain or push-pull. Voltage Domain: 3.3 V
	TCK	I		JTAG Test Clock The signals TDI, TDO, and TMS are synchronous, subject to this JTAG test clock. Voltage Domain: 3.3 V
	FW_UTXD	O		Firmware UART Data Output Firmware UART interface data output Voltage Domain: 3.3 V
J2	PHYLED2_3	I/O		GPHY LED2 for Port 3 LED control output, drives single-color or dual color LEDs. Voltage Domain: 3.3 V
	GPIO30	Prg	Prg	General Purpose IO 30 Either input or output mode. The output characteristic is either open drain or push-pull. Voltage Domain: 3.3 V
	TDO	I/O		JTAG Serial Test Data Output JTAG test data output. Voltage Domain: 3.3 V <i>Note: No external pull-up required.</i>
H3	PHYLED3_3	I/O		GPHY LED3 for Port 3 LED control output, drives single-color or dual color LEDs. Voltage Domain: 3.3 V
	GPIO31	Prg	Prg	General Purpose IO 31 Either input or output mode. The output characteristic is either open drain or push-pull. Voltage Domain: 3.3 V
J3	PHYLED1_4	I/O		GPHY LED1 for Port 4 LED control output, drives single-color or dual color LEDs. Voltage Domain: 3.3 V
	GPIO32	Prg	Prg	General Purpose IO 32 Either input or output mode. The output characteristic is either open drain or push-pull. Voltage Domain: 3.3 V
	FW_UTXD	O		Firmware UART Data Output Firmware UART interface data output Voltage Domain: 3.3 V

Table 10 LED and Debug Interface Signals (cont'd)

Ball No.	Name	Pin Type	Buffer Type	Function
K2	PHYLED2_4	I/O		GPHY LED2 for Port 4 LED control output, drives single-color or dual color LEDs. Voltage Domain: 3.3 V
	GPIO33	Prg	Prg	General Purpose IO 33 Either input or output mode. The output characteristic is either open drain or push-pull. Voltage Domain: 3.3 V
L3	PHYLED3_4	I/O		GPHY LED3 for Port 4 LED control output, drives single-color or dual color LEDs. Voltage Domain: 3.3 V
	GPIO34	Prg	Prg	General Purpose IO 34 Either input or output mode. The output characteristic is either open drain or push-pull. Voltage Domain: 3.3 V
M1	PHYLED1_5	I/O		GPHY LED1 for Port 5 LED control output, drives single-color or dual color LEDs. Voltage Domain: 3.3 V
	GPIO35	Prg	Prg	General Purpose IO 35 Either input or output mode. The output characteristic is either open drain or push-pull. Voltage Domain: 3.3 V
	FW_UTXD	O		Firmware UART Data Output Firmware UART interface data output Voltage Domain: 3.3 V
M3	PHYLED2_5	I/O		GPHY LED2 for Port 5 LED control output, drives single-color or dual color LEDs. Voltage Domain: 3.3 V
	GPIO36	Prg	Prg	General Purpose IO 36 Either input or output mode. The output characteristic is either open drain or push-pull. Voltage Domain: 3.3 V
L2	PHYLED3_5	I/O		GPHY LED3 for Port 5 LED control output, drives single-color or dual color LEDs. Voltage Domain: 3.3 V
	GPIO37	Prg	Prg	General Purpose IO 37 Either input or output mode. The output characteristic is either open drain or push-pull. Voltage Domain: 3.3 V

Table 10 LED and Debug Interface Signals (cont'd)

Ball No.	Name	Pin Type	Buffer Type	Function
M2	PHYLED1_6	I/O		GPHY LED1 for Port 6 LED control output, drives single-color or dual color LEDs. Voltage Domain: 3.3 V
	GPIO38	Prg	Prg	General Purpose IO 38 Either input or output mode. The output characteristic is either open drain or push-pull. Voltage Domain: 3.3 V
	FW_UTXD	O		Firmware UART Data Output Firmware UART interface data output Voltage Domain: 3.3 V
N3	PHYLED2_6	I/O		GPHY LED2 for Port 6 LED control output, drives single-color or dual color LEDs. Voltage Domain: 3.3 V
	GPIO39	Prg	Prg	General Purpose IO 39 Either input or output mode. The output characteristic is either open drain or push-pull. Voltage Domain: 3.3 V
N2	PHYLED3_6	I/O		GPHY LED3 for Port 6 LED control output, drives single-color or dual color LEDs. Voltage Domain: 3.3 V
	GPIO40	Prg	Prg	General Purpose IO 40 Either input or output mode. The output characteristic is either open drain or push-pull. Voltage Domain: 3.3 V
P1	PHYLED1_7	I/O		GPHY LED1 for Port 7 LED control output, drives single-color or dual color LEDs. Voltage Domain: 3.3 V
	GPIO41	Prg	Prg	General Purpose IO 41 Either input or output mode. The output characteristic is either open drain or push-pull. Voltage Domain: 3.3 V
	FW_UTXD	O		Firmware UART Data Output Firmware UART interface data output Voltage Domain: 3.3 V
P2	PHYLED2_7	I/O		GPHY LED2 for Port 7 LED control output, drives single-color or dual color LEDs. Voltage Domain: 3.3 V
	GPIO42	Prg	Prg	General Purpose IO 42 Either input or output mode. The output characteristic is either open drain or push-pull. Voltage Domain: 3.3 V

Table 10 LED and Debug Interface Signals (cont'd)

Ball No.	Name	Pin Type	Buffer Type	Function
P3	PHYLED3_7	I/O		GPHY LED3 for Port 7 LED control output, drives single-color or dual color LEDs. Voltage Domain: 3.3 V
	GPIO43	Prg	Prg	General Purpose IO 43 Either input or output mode. The output characteristic is either open drain or push-pull. Voltage Domain: 3.3 V
R3	TRSTN	I		JTAG Test Enabling At logic HIGH, the GPIO pins are used as JTAG interface (TCK, TDI, TDO, and TMS). At logic LOW, the GPIO pins are used in their normal application mode. Voltage Domain: 3.3 V

2.2.3.8 Miscellaneous Signals

Table 11 Miscellaneous Signals

Ball No.	Name	Pin Type	Buffer Type	Function
Reset and Clocking				
E17	XTAL1	AI	A	Crystal: Oscillator Input A crystal must be connected between XTAL1 and XTAL2. Additional load capacitances must tie both pins to GND.
	CLK	AI	A	Crystal Oscillator: Clock Input A clock of 25 or 50 MHz must be connected to CLK. See Section 7.7.2 for the clock details. XTAL2 must not be connected.
E16	XTAL2	AO	A	Crystal: Oscillator Output A crystal must be connected between XTAL1 and XTAL2. Additional load capacitances must tie both pins to GND.
G18	CLKP_0	AO	A	Differential Reference Clock Output 0 These pins provide the 25, 50, or 156.25 MHz differential reference clock used for a clock slave device.
G17	CLKN_0	AO	A	Differential Reference Clock Output 0 These pins provide the 25, 50, or 156.25 MHz differential reference clock used for a clock slave device.
N17	CLKP_1	AO	A	Differential Reference Clock Output 1 These pins provide the 25, 50, or 156.25 MHz differential reference clock used for a clock slave device.
N18	CLKN_1	AO	A	Differential Reference Clock Output 1 These pins provide the 25, 50, or 156.25 MHz differential reference clock used for a clock slave device.
J17	GPC0	Prg		General Purpose Clock 0 General purpose clock for external devices. Either input or output mode. Voltage Domain: 3.3 V
	GPIO44	Prg	Prg	General Purpose IO 44 Either input or output mode. The output characteristic is either open drain or push-pull. Voltage Domain: 3.3 V
	WSP_UTXD	Prg	Prg	Software UART Data Output Voltage Domain: 3.3 V

Table 11 Miscellaneous Signals (cont'd)

Ball No.	Name	Pin Type	Buffer Type	Function
J18	GPC1	Prg		General Purpose Clock 1 General purpose clock for external devices. Either input or output mode. Voltage Domain: 3.3 V
	GPIO45	Prg	Prg	General Purpose IO 45 Either input or output mode. The output characteristic is either open drain or push-pull. Voltage Domain: 3.3 V
	WSP_UTXD	Prg	Prg	Software UART Data Output Voltage Domain: 3.3 V
J16	GPC2	Prg		General Purpose Clock 2 General purpose clock for external devices. Either input or output mode. Voltage Domain: 3.3 V
	GPIO46	Prg	Prg	General Purpose IO 46 Either input or output mode. The output characteristic is either open drain or push-pull. Voltage Domain: 3.3 V
	WSP_URXD	Prg	Prg	Software UART Data Input Voltage Domain: 3.3 V
H17	GPC3	Prg		General Purpose Clock 3 General purpose clock for external devices. Either input or output mode. Voltage Domain: 3.3 V
	GPIO47	Prg	Prg	General Purpose IO 47 Either input or output mode. The output characteristic is either open drain or push-pull. Voltage Domain: 3.3 V
L16	GPIO0	Prg	Prg	General Purpose IO 0 Either input or output mode. The output characteristic is either open drain or push-pull. Voltage Domain: 1.8 V / 3.3 V
	EXTINT0	Prg	Prg	External Interrupt 0 Voltage Domain: 1.8 V / 3.3 V
D5	GPIO1	Prg	Prg	General Purpose IO 1 Either input or output mode. The output characteristic is either open drain or push-pull. Voltage Domain: 3.3 V
	EXTINT1	Prg	Prg	External Interrupt 1 Voltage Domain: 3.3 V
	WSP_URXD	Prg	Prg	Software UART Data Input Voltage Domain: 3.3 V

Table 11 Miscellaneous Signals (cont'd)

Ball No.	Name	Pin Type	Buffer Type	Function
P4	GPIO2	Prg	Prg	General Purpose IO 2 Either input or output mode. The output characteristic is either open drain or push-pull. Voltage Domain: 3.3 V
K4	GPIO3	Prg	Prg	General Purpose IO 3 Either input or output mode. The output characteristic is either open drain or push-pull. Voltage Domain: 3.3 V

2.2.3.9 Power Supply for GPHY

Table 12 Power Supply Pins for GPHY

Ball No.	Name	Pin Type	Buffer Type	Function
C12	VDDA3V3_0	PWR		GPHY 0 High Voltage Domain Supply This is the PHY 0 AFE 3.3 V supply.
C10	VDDA3V3_1	PWR		GPHY 1 High Voltage Domain Supply This is the PHY 1 AFE 3.3 V supply.
C8	VDDA3V3_2	PWR		GPHY 2 High Voltage Domain Supply This is the PHY 2 AFE 3.3 V supply.
C6	VDDA3V3_3	PWR		GPHY 3 High Voltage Domain Supply This is the PHY 3 AFE 3.3 V supply.
T6	VDDA3V3_4	PWR		GPHY 4 High Voltage Domain Supply This is the PHY 4 AFE 3.3 V supply.
T8	VDDA3V3_5	PWR		GPHY 5 High Voltage Domain Supply This is the PHY 5 AFE 3.3 V supply.
T10	VDDA3V3_6	PWR		GPHY 6 High Voltage Domain Supply This is the PHY 6 AFE 3.3 V supply.
T12	VDDA3V3_7	PWR		GPHY 7 High Voltage Domain Supply This is the PHY 7 AFE 3.3 V supply.
D8	VDDA1V8_0	PWR		GPHY 0, 1, 2, 3 AFE Voltage Domain Supply This is the 1.8 V supply for PHY 0 to PHY 3 AFE voltage domain. It supplies mixed signal blocks in the AFE.
R8	VDDA1V8_1	PWR		GPHY 4, 5, 6, 7 AFE Voltage Domain Supply This is the 1.8 V supply for PHY 4 to PHY 7 AFE voltage domain. It supplies mixed signal blocks in the AFE.
F7, F12	VDDA0V8_0	PWR		GPHY 0, 1, 2, 3 Low Voltage Domain Supply This is the supply for PHY 0 to PHY 3 low voltage domain. It supplies mixed signal blocks in the AFE.
N7, N12	VDDA0V8_1	PWR		GPHY 4, 5, 6, 7 Low Voltage Domain Supply This is the supply for PHY 4 to PHY 7 low voltage domain. It supplies mixed signal blocks in the AFE.
G4, H4, L4, M4	VDD3V3PAD0	PWR		Power Supply Digital Domain 3.3 V 3.3 V Voltage Digital Power Supply
F15, G15, P15	VDD3V3PAD1	PWR		Power Supply Digital Domain 3.3 V 3.3 V Voltage Digital Power Supply
J15	VDDP_PAD	PWR		Power Supply Digital Domain 1.8 V / 3.3 V 3.3 V or 1.8 V Pad Voltage Digital Power Supply based on pin strapping.

Table 12 Power Supply Pins for GPHY (cont'd)

Ball No.	Name	Pin Type	Buffer Type	Function
G6, H6, G8, H8, H10, H11, G12, G13, J7, K7, J9, K9, L6, M6, L8, M8, L10, L11, M12, M13	VDDD0V8_COR	PWR		Power Supply Digital Domain 0.8 V 0.8 V Core Voltage Digital Power Supply
J13	VDDA1V8PORXO	PWR		Power Supply Domain 1.8 V
D9	VDDA1V8_0	PWR		Power Supply Domain 1.8 V
R9	VDDA1V8_1	PWR		Power Supply Domain 1.8 V
F10, G10	VDDA1V2CDB0	PWR		Power Supply Domain 1.2 V
M10, N10	VDDA1V2CDB1	PWR		Power Supply Domain 1.2 V
F9	VDDA0V8_0	PWR		Power Supply Domain 0.8 V
N9	VDDA0V8_1	PWR		Power Supply Domain 0.8 V
L13	VDDA1V8_PLL	PWR		Power Supply Domain 1.8 V
J11	VDDD0V8REF	PWR		Power Supply Digital Domain 0.8 V
K11	VDDD0V8POST	PWR		Power Supply Digital Domain 0.8 V
H12	VDDA1V8_CML	PWR		Power Supply Domain 1.8 V
K12	VDDA0V8_CML	PWR		Power Supply Domain 0.8 V
K13	VDDA1V8_PVT	PWR		Power Supply Domain 1.8 V
J12	VCC1V8_OTP	PWR		Power Supply Domain 1.8 V

2.2.3.10 Power Supply for USXGMII

Table 13 Power Supply Pins for USXGMII

Ball No.	Name	Pin Type	Buffer Type	Function
C15, D14	VA0V8_0	PWR		USXGMII 0 - 0.8 V Analog Domain Supply
D15	VPHA1V8_0	PWR		USXGMII 0 - 1.8 V Domain Supply
R14, T15	VA0V8_1	PWR		USXGMII 1 - 0.8 V Analog Domain Supply
R15	VPHA1V8_1	PWR		USXGMII 1 - 1.8 V Domain Supply

2.2.3.11 Power Supply for TPI (AFE)

Table 14 Power Supply Pins for TPI (AFE)

Ball No.	Name	Pin Type	Buffer Type	Function
A1, A16, C4, C5, C7, C9, C11, C13, C14, D2, D6, D7, D10, D12, D13, F6, F8, F11, F13	TPVSSA_0	GND		Analog Ground
N6, N8, N11, N13, R2, R6, R7, R10, R12, R13, T4, T5, T7, T9, T11, T13, T14, V1, V16	TPVSSA_1	GND		Analog Ground

2.2.3.12 Ground

Table 15 Ground Pins

Ball No.	Name	Pin Type	Buffer Type	Function
D3, D4, E15, F4, G7, H7, G9, H9, G11, H15, H16, J4, J6, K6, J8, K8, J10, K10, K1, K3, K15, L7, M7, L9, M9, M11, L12, N4, N16, R4, R5	VSSD	GND		Digital Ground
A18, B18, C16, D18, R18, T16, U18, V18	UVSS	GND		USXGMII Ground
D16, D17, F16, H13	VSS_XO	GND		XO Device Ground XO ground

3 Functional Description

3.1 Power Supply, Clock, and Reset

This section provides the information required to power up the MxL86282S.

3.1.1 Power Supply

These four power supply rails are required: 3.3 V, 0.8 V, 1.8 V, and 1.2 V. [Section 7.7.1](#) contains the power-up sequence.

3.1.2 Clock

An internal PLL circuit generates the required internal clocks, based on an external reference clock.

The available options are:

- An external 25 MHz crystal connected to the MxL86282S. [Section 7.7.11](#) documents the required crystal specification.
- 25 MHz direct from an external oscillator
- An external CML/LVPECL reference clock operating at 50 MHz

The MxL86282S provides two pairs of CML differential clock output to drive other chips. The available clock frequencies are:

- Input reference clock frequency
- 50 MHz
- 156.25 MHz

3.1.3 Reset Generation

The external hardware reset input (HRSTN pin) resets all the hardware modules including the pin strapping information during boot:

- Driving the HRSTN pin low causes an asynchronous reset of the MxL86282S system.
- Releasing the HRSTN pin high triggers the power-on sequence.

The HRSTN pin is internally connected to a weak internal pull-up resistor.

3.1.4 Power-On Sequence

The MxL86282S powers on when the power is applied and the HRSTN pin is high. See [Figure 25](#).

The steps executed at power on are:

1. Lock the internal PLL.
2. Read the pin strap information, see [Section 3.1.5](#) for more information.
3. Boot the microprocessor from the internal ROM.
4. Authenticate the firmware image in the flash memory device.
5. Auto-negotiate the link speeds for the Ethernet TPI and USXGMII interfaces.
6. Train and link up each interface in accordance with the IEEE 802.3 [\[6\]](#) standards.

3.1.5 Configuration by Pin Strapping

The MxL86282S is configurable by means of pin strapping on a number of the GPIO pins. The pin strapping configurations are captured during the chip power-on sequence until the reset initialization is complete.

The pin strap values are set to logical high or low by connecting the corresponding pin via an external 1 kΩ resistor to either ground or the pin supply voltage.

Table 16 and **Table 17** describe the pin strap mapping.

Table 16 Pin Names Used for Pin Strapping

Ball Name	Ball Number	Configuration Item Description
GPC1	J18	PS_PHY_MADDR(4)
GPC2	J16	PS_PHY_MADDR(3)
GPC3	H17	PS_CLK_SEL
GPIO1	D5	PS_CLK_SEL1
GPIO2	P4	PS_RJ45_TAB
MDINT	G16	PS_MDINT_POLARITY
GPIO3	K4	PS_MDIO_VOLTAGE
GPC0	J17	PS_SUPER_ISOLATE

Table 17 Pin Strapping Configuration Description

Pin Strapping Signals	Description
PS_PHY_MADDR(4:3)	MDIO Address Specifies the most significant two bits of the MDIO address. The lowest three bits of the switch MDIO address are hard-coded to 0.
PS_MDINT_POLARITY	MDIO Interrupt Polarity Specifies the polarity of the MDIO interrupt. 0 _B HIGH MDIO interrupt is active high. 1 _B LOW MDIO interrupt is active low.
PS_RJ45_TAB	RJ45 Tab Configuration Specifies the tab-up or tab-down configuration of the RJ45. Each BASE-T port has the same configuration. 1 _B DOWN Tab-down 0 _B UP Tab-up
PS_MDIO_VOLTAGE	MDIO Voltage Specifies whether the maximum voltage level used by the MDIO signals is 3.3 V or 1.8 V. 0 _H LOW MDIO_S, MDC_S, MDINT, MDIO_M, MDC_M, and GPIO0 signal pins are supplied with 1.8 V. In this configuration, V _{DDP} must be supplied with 1.8 V. 1 _H NORMAL MDIO_S, MDC_S, MDINT, MDIO_M, MDC_M, and GPIO0 signal pins are supplied with 3.3 V. In this configuration, V _{DDP} must be supplied with 3.3 V.

Table 17 Pin Strapping Configuration Description (cont'd)

Pin Strapping Signals	Description
PS_CLK_SEL PS_CLK_SEL1	<p>Input Clock Selection Specifies the input clock frequency used. MSB is PS_CLK_SEL1. LSB is PS_CLK_SEL.</p> <p>11_B 25 25 MHz 10_B 50 50 MHz 01_B RES Reserved 00_B RES Reserved</p>
PS_SUPER_ISOLATE	<p>Super Isolate Specifies whether the PHY is immediately active after a reset or is halted until it is manually activated.</p> <p>0_H HALT The PHYs are inactive after reset. 1_H NORMAL The PHYs are active after reset.</p>

Alternative ways to configure the MxL86282S after the boot process are to use the MDIO interface [5] and write into various control registers, as detailed in Section 3.3, or to use the FCA [2].

3.2 MDIO Slave Interface

The SMDIO module and the MDIO Device 30 module are directly attached to the MDIO slave interface as shown in the [Figure 4](#). The MDIO Device 30 is the vendor specific 1 device for MMD=30, which supports both IEEE 802.3 clause 22 and clause 45 protocol. It allows access to the switch and the PHY configurations using the correct MDIO PHY address. The MDIO address used for this access is configurable through pin-strapping, as described in [Section 3.1.5](#). A switch driver executed by the micro-controller in the figure allows configuration of the MxL86282S. The switch driver is part of the host SoC API software documented in the MxL86282S API.

The SMDIO module provides access to the external flash memory device via the QSPI interface. The MxL86282S supports downloading of firmware to the flash memory device via the SMDIO module attached to the MDIO bus. The MDIO address used for this access is the same MDIO address as defined by the pin strapping. The MxL86282S user guide [\[2\]](#) or [\[5\]](#) describes the driver software executed on the external processor which must be followed to perform this feature. The SMDIO module supports only IEEE 802.3 clause 22 protocol.

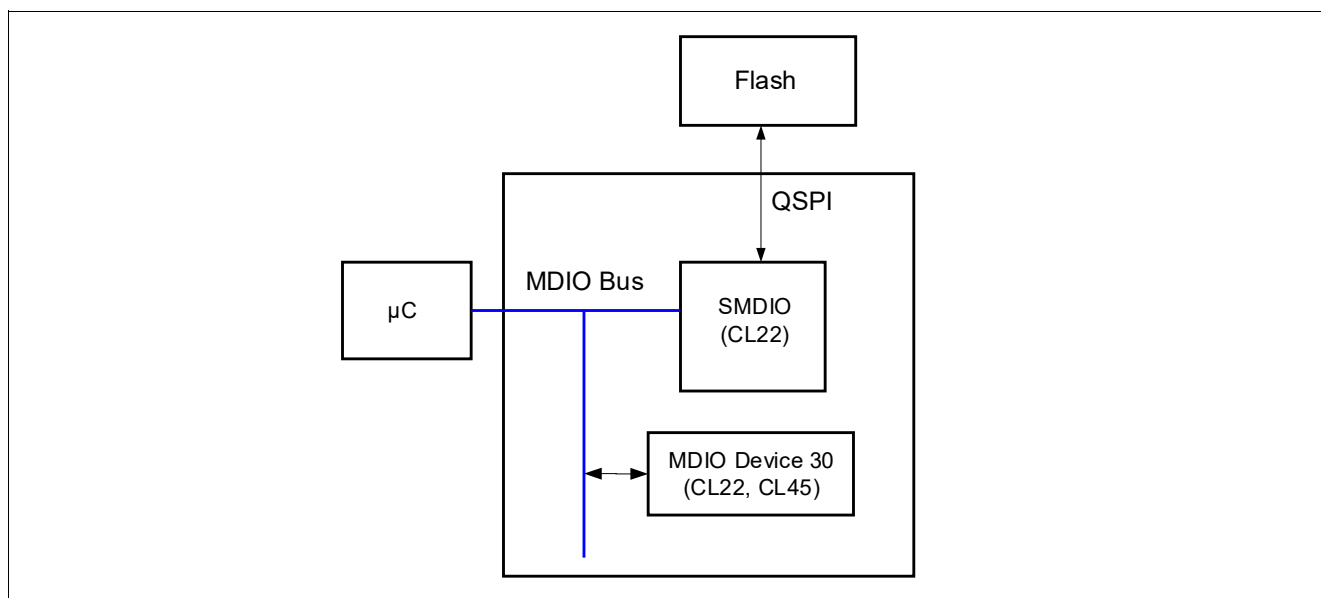

Figure 4 MDIO Slave

When other devices in the system need to be configured through MDIO, they must be connected to the MDIO slave interface and configured such that no addressing conflict arises.

The standard MDIO protocol requires a 32-bit preamble at the beginning of each read or write access. To speed up the data exchange, reduce the preamble down to 1 bit for the second and subsequent accesses.

The standard MDIO protocol uses a clock rate of 2.5 MHz on MDC. To speed up the data exchange, increase the clock applied on MDC_S to the maximum 25 MHz. [Section 7.7.4](#) contains more details on AC characteristics.

3.3 Configuration via MDIO Management Interface

It is possible to connect an external controller's STA to the chip's slave MDIO interface. This allows access to the MDIO and MMD registers standardized in IEEE 802.3, enabling the STA to control the chip configuration and retrieve status information. The MDIO transactions are any of the three types described in IEEE 802.3 Clause 22, Clause 22 Extended, and Clause 45 [6].

Figure 5 and Table 18 show the minimum time required for the MDIO to be available for access.

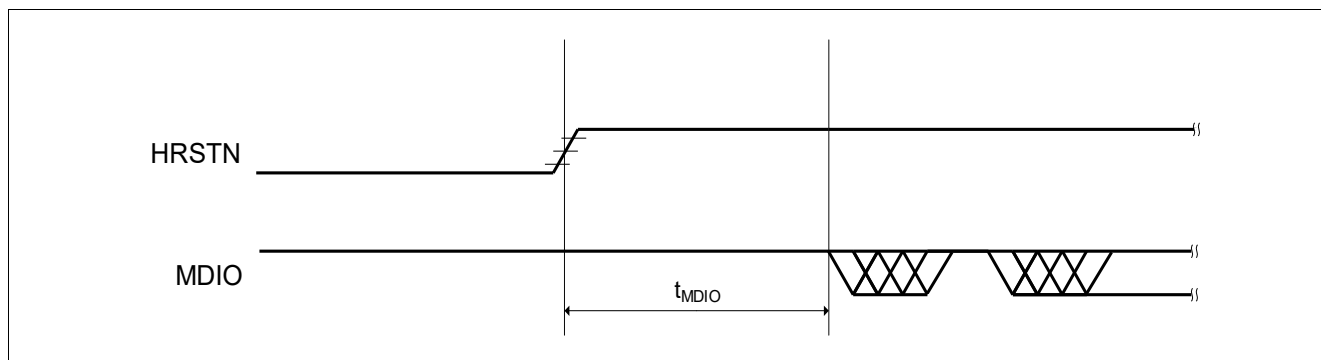

Figure 5 MDIO Access Timing

Table 18 MDIO Ready Timing

Parameter	Symbol	Values			Unit	Note / Test Condition
		Min.	Typ.	Max.		
MDIO Ready Time	T_{MDIO}	750	–	–	ms	

3.4 MDIO Master Interface

The MDIO master module provides the register interface to access the registers of external Ethernet PHYs.

The interface uses the serial protocol defined by IEEE 802.3, clause 22 or clause 45. It is possible to address up to 32 external devices through a 5-bit PHY address (PHYADR). Each MDIO access includes start type (clause 22 or 45), access type (address/read/write/post-increment command), 5-bit PHY address, 5-bit register/device address, and 16-bit read/write data.

The MDIO master interface shares pins with the GPIO function. When there is no requirement to access an external PHY or device via the MDIO master interface, the pins are configurable for GPIO or an alternative function as shown in the [Chapter 2 External Signals](#).

3.5 I²C Master Interface

The MxL86282S has two chip-integrated I²C master controllers to handle SFPs. The Inter-IC (I²C) Bus was developed by Philips Semiconductors (now NXP Semiconductors). This specification is compliant with [12].

The I²C is a simple, bi-directional half-duplex bus with data transfers of up to 100 Kbps in standard mode, up to 400 Kbps in fast mode, up to 1000 Kbps in fast mode plus, and up to 3.4 Mbps in high-speed (hs) mode.

I²C provides a protocol allowing devices to communicate directly with each other via two wires. One line is responsible for the clock synchronization (SCL), the other is responsible for the data transfer (SDA). The number of devices connected to the I²C bus is limited only by a maximum bus capacity of 400 pF. Each device is recognized by a unique address.

The two bi-directional bus lines, a Serial Data (SDA) line and a Serial Clock (SCL) line, are connected to a positive supply voltage via pull-up resistors. The output stages of devices must have an open drain to perform the required wired-AND function. One line is pulled low when one of the open-drain transistors is selected. Otherwise, no signal is asserted to the line. The external pull-up resistors lift the level to HIGH.

The I²C specification defines a master/slave relationship where each device works either as a transmitter or a receiver depending on the device function. This functionality is set in the initialization procedure of each module.

Features

- Two identical I²C controllers
- Master-mode supported
- Compatible to the I²C specification version 6.0, April 2014¹⁾
- Data transfer in standard- (0 to 100 kBaud), fast- (0 to 400 kBaud), fast mode plus (0 to 1 Mbps) and high-speed mode (0 to 3.4 Mbps)

1) For deviations of timing values compared to the Philips Semiconductors (now NXP Semiconductors*) specifications, see [Chapter 7 Electrical Characteristics](#).

3.6 Quad Serial Peripheral Interface

A Quad Serial Peripheral Interface (QSPI) is equipped to provide access to external Quad-SPI flash memory devices. The MxL86282S requires an external Quad-SPI flash memory to operate.

The QSPI supports:

- Up to 101.5625 MHz for single/double data rate
- eXecution In Place (XIP), fully memory mapped access for CPU
- Addressing up to 512 MB range

3.6.1 Supported Flash Memory Devices

Table 19 lists the qualified flash memory devices. However, it is possible for the user to select a device not present in the list after consideration of command compatibility and timing compatibility as listed in **Table 20**. The flash memory device must support 101.5625 MHz single data rate.

Table 19 Supported Flash Memory Devices

Vendor	Model
Macronix	MX25L6433F
Winbond	W25Q64JV-DTR

Table 20 Flash Command and Timing

Instruction	Abbreviation	Command	Command Cycles	Address Cycles	Dummy Cycles	Data Cycles
Write Enable	WREN	06 _H	8	0	0	0
Write Disable	WRDI	04 _H	8	0	0	0
Read ID	RDID	9F _H	8	0	0	24
Read Status Register	RDSR	05 _H	8	0	0	8
Write Status Register	WRSR	01 _H	8	0	0	8
Read Configuration Register	RDCR	15 _H	8	0	0	8
Read Data Bytes	READ	03 _H	8	24	0	8
Fast Read	FREAD	0B _H	8	24	8	8
Quad Read	4READ	EB _H	8	6	10	2
XIP	XIP	EB _H	8	6	10	2 x n ¹⁾
Chip Erase	CE	C7 _H	8	0	0	0
Block Erase	BE	D8 _H	8	24	0	0
Sector Erase	SE	20 _H	8	24	0	0
Page Program	PP	02 _H	8	24	0	8 x n ¹⁾
Reset Enable	RSTEN	66 _H	8	0	0	0
Reset	RST	99 _H	8	0	0	0

1) n is the number of bytes

3.7 GPIO Mapping

Other than the GPIO functionality, the GPIO pins are also shared with other alternative functions. The GPIO pins are configurable to alternative functions, which are based on the pinmux settings as shown in [Table 21](#).

Table 21 GPIO Mapping

Pinmux Mode 0 (Default)	Pinmux Mode 1	Pinmux Mode 2	Pinmux Mode 3
GPIO0	GPIO0	EXTINT0	—
GPIO1	GPIO1	EXTINT1	WSP_URXD
GPIO2	GPIO2	—	—
GPIO3	GPIO3	—	—
MDINT	GPIO4	—	—
MDC_S	GPIO5	—	—
MDIO_S	GPIO6	—	—
MDC_M	GPIO7	—	—
MDIO_M	GPIO8	—	—
QSPI_D0	GPIO9	—	—
QSPI_D1	GPIO10	—	—
QSPI_D2	GPIO11	—	—
QSPI_D3	GPIO12	—	—
QSPI_CLK	GPIO13	—	—
QSPI_CS	GPIO14	—	—
QSPI_RST	GPIO15	—	—
I2C_SCL_0	GPIO16	—	—
I2C_SDA_0	GPIO17	—	—
I2C_SCL_1	GPIO18	—	—
I2C_SDA_1	GPIO19	—	—
PHYLED1_0	GPIO20	—	FW_UTXD
PHYLED2_0	GPIO21	—	FW_URXD
PHYLED3_0	GPIO22	—	—
PHYLED1_1	GPIO23	—	—
PHYLED2_1	GPIO24	—	—
PHYLED3_1	GPIO25	—	—
PHYLED1_2	GPIO26	—	TDI
PHYLED2_2	GPIO27	—	TMS
PHYLED3_2	GPIO28	—	—
PHYLED1_3	GPIO29	—	TCK
PHYLED2_3	GPIO30	—	TDO
PHYLED3_3	GPIO31	—	—
PHYLED1_4	GPIO32	—	—
PHYLED2_4	GPIO33	—	—
PHYLED3_4	GPIO34	—	—

Table 21 GPIO Mapping (cont'd)

Pinmux Mode 0 (Default)	Pinmux Mode 1	Pinmux Mode 2	Pinmux Mode 3
PHYLED1_5	GPIO35	—	—
PHYLED2_5	GPIO36	—	—
PHYLED3_5	GPIO37	—	—
PHYLED1_6	GPIO38	—	—
PHYLED2_6	GPIO39	—	—
PHYLED3_6	GPIO40	—	—
PHYLED1_7	GPIO41	—	—
PHYLED2_7	GPIO42	—	—
PHYLED3_7	GPIO43	—	—
GPC0	GPIO44	WSP_UTXD	—
GPC1	GPIO45	—	WSP_UTXD
GPC2	GPIO46	—	WSP_URXD
GPC3	GPIO47	—	—

3.8 Ethernet PHY Interface

The Ethernet PHY implements the physical layer of the Ethernet standard. It supports Digital Signal Processing (DSP) and Analog Signal Processing (ASP) functions in transmitting data over the twisted pair cable.

3.8.1 Twisted Pair Interface

The Twisted Pair Interface (TPI) of the MxL86282S is fully compliant with IEEE 802.3. The MxL86282S integrates series resistors required to terminate the TPI links with a 100 Ω nominal impedance to facilitate a low-power implementation and reduce PCB costs. As a consequence, it is possible to connect the TPI pins directly via a transformer to the RJ45 connector. Additional external circuitry is required for common-mode termination and rejection as described in [Section 7.8.1](#).

[Figure 6](#) shows a schematic of the TPI circuitry taking these components into account.

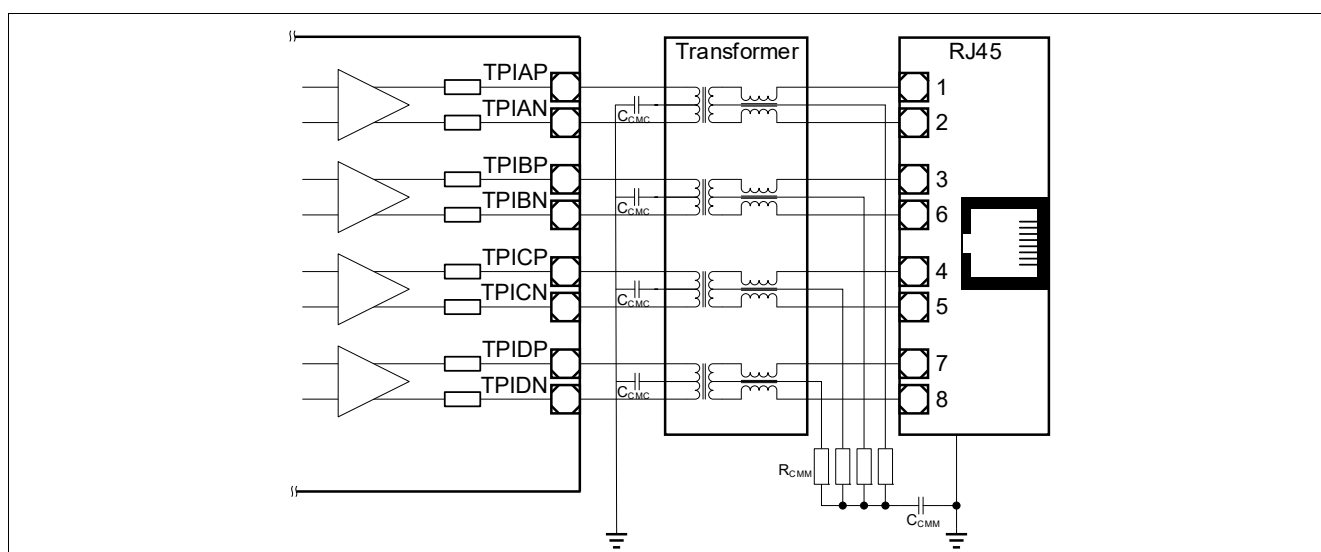

Figure 6 Twisted-Pair Interface of MxL86282S Including Transformer and RJ45 Plug

3.8.2 Transformerless Ethernet

Transformerless Ethernet (TLE) is required for backplane applications where the use of a transformer is not always required to fulfill the galvanic decoupling requirements of the isolation specifications. In such applications, removing the transformer reduces both the external bill of material and the space requirements on the PCB.

As the MxL86282S incorporates a voltage-mode line driver, the only stringent requirement is to use AC coupling, which is achievable using simple SMD type series capacitors. The value of the capacitors is selected such that the high-pass characteristics correspond to an equivalent standard transformer based application. The recommended value is $C_{\text{coupling}} = 100 \text{ nF}$. [Figure 7](#) shows the external circuitry for TLE.

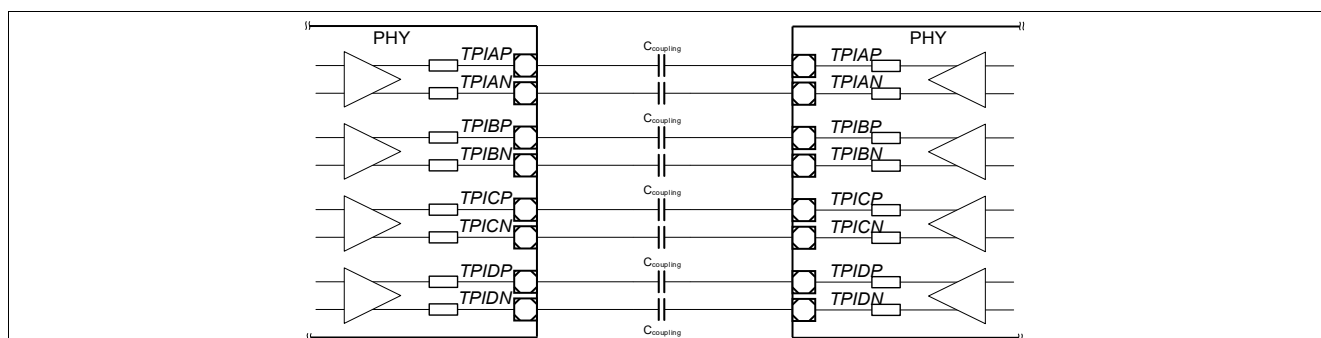

Figure 7 External Circuitry for the Transformerless Ethernet Application

3.8.3 Auto-Negotiation

The MxL86282S supports auto-negotiation (ANEG) as part of the startup procedure to exchange capability information with the link partner. ANEG is enabled at the MxL86282S initialization and its 2.5 Gbps speed capability is advertised. The ANEG procedure is executed according to IEEE 802.3 Clause 28, Clause 40, and IEEE 802.3 Clause 126 [6]. When the link partner does not support ANEG, the MxL86282S determines the link speed configuration using parallel detection as described in Clause 28.

With MDIO commands, it is possible to disable ANEG and change the advertised link rates. The STA is also able to disable ANEG. In this situation, the system configuration must ensure compatibility between link partners to allow link up in a compatible mode.

Attention: *STD_CTRL.DPLX only takes effect when the ANEG process is disabled and the GPHY TPI is not operating in loopback mode, that is, bits STD_CTRL.ANEN and STD_CTRL.LB are set to zero. Forced half-duplex mode (STD_CTRL.DPLX = 0b0) is only supported in 10BASE-T and 100BASE-TX speed modes. This field is ignored for higher speeds.*

3.8.4 Auto-Downspeed

The auto-downspeed (ADS) feature implements a process to renegotiate the link with a lower speed when the link quality is insufficient. The feature ensures maximum interoperability even in harsh, or inadequate, cable infrastructure environments. In particular, ADS is applied during the 2.5GBASE-T/1000BASE-T training phase. ADS is also required when the quality or characteristics of the cable in use cannot support the advertised speed.

For example, it is possible to advertise 2.5GBASE-T/1000BASE-T during ANEG when both link partners are connected via a cable that does not support the 4-pair Gigabit Ethernet mode. The MxL86282S detects such a configuration to avoid repeating link up failures and clears the 2.5GBASE-T/1000BASE-T capability in the ANEG advertisement registers. After the resulting link down, the next ANEG procedure no longer advertises 1000BASE-T/2.5GBASE-T. The next link up is done at the next advertised speed below 1000 Mbps.

The MxL86282S also executes an ADS procedure when the signal quality is not suited to a 1000BASE-T/2.5GBASE-T link up due to increased alien noise or a loop length that significantly exceeds the standard specification.

When the MxL86282S is configured not to advertise a speed capability below 1000 Mbps, the ADS feature is automatically disabled.

3.8.5 Polarity Reversal Correction

For each of the 4 pairs, the MxL86282S automatically detects and corrects any inversion of the signal polarity on the P and N signals. The detection is done during the auto-negotiation phase. The detected polarity is frozen when the link is established, and remains unchanged until the link is dropped.

The polarity corrections applied are indicated in the register: PMA_MGBT_POLARITY (register 1.130); and are valid after auto-negotiation is complete.

3.8.6 Auto-Crossover Correction

To maximize interoperability, even in inadequate wiring environments, the MxL86282S automatically performs cable crossover (MDI-X) correction. [Table 22](#) lists the supported pair-mappings detectable and correctable by the device.

The MxL86282S automatically detects and corrects crossed cable configuration, where the transmit-receive pairing between partners does not match. The auto-crossover function is fully compliant with IEEE 802.3, Clause 40.4.4 [6], in 1000BASE-T and 2.5GBASE-T mode.

The corrections applied are indicated in the register: PMA_MGBT_POLARITY (register 1.130) and are valid when auto-negotiation is complete.

Table 22 Supported Twisted Pair Mappings on a Cat 5 or Better Cable

Crossover Modes on RJ45 ¹⁾		RJ45 Pinning							
Mode	Description	1	2	3	4	5	6	7	8
11	Straight cable, standard compliant	TPIAP (A+)	TPIAN (A-)	TPIBP (B+)	TPICP (C+)	TPICN (C-)	TPIBN (B-)	TPIDP (D+)	TPIDN (D-)
00	Full Gigabit Ethernet MDI-X This is standard-compliant MDI-X with pair A/B swapped and pair C/D swapped.	TPIBP (B+)	TPIBN (B-)	TPIAP (A+)	TPIDP (D+)	TPIDN (D-)	TPIAN (A-)	TPICP (C+)	TPICN (C-)

1) This pin assignment is according to TIA/EIA-568-A/B.

3.8.7 RJ45 Tab Up or Tab Down Configuration

Figure 8 shows that the RJ45 plug on the system PCB is solderable with the tab either up or down.

The difference between tab up and tab down is a swap in position between A and D, and a swap in position between B and C. The pin strap `PS_RJ45_TAB` allows the system designer to perform this configuration. As a result, a PCB layout does not need to be modified when a RJ45 tab up or down socket needs to be mounted. The single pin strap is applicable to all ports, which are either all tab down or all tab up.

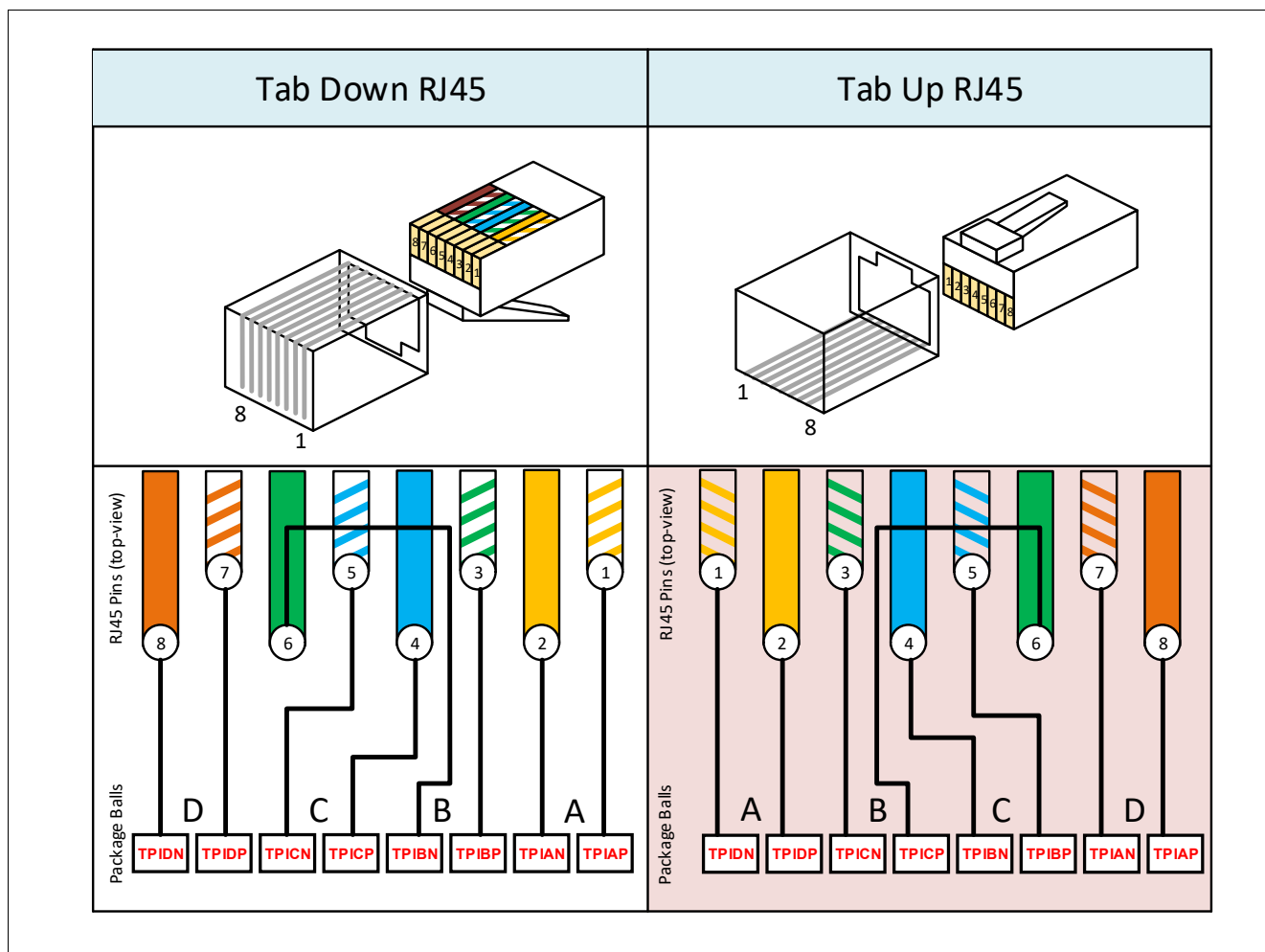

Figure 8 RJ45 Tab Up or Tab Down Configuration

3.8.8 Wake-on-LAN

The MxL86282S supports WoL. The MxL86282S generates an interrupt to an external controller or to an internal controller when it detects special WoL Ethernet packets. This allows the controller to enter sleep mode when there is no Ethernet traffic to process, and be woken up when traffic starts. WoL packets are detected at all link speeds. **Figure 9** shows the scenario when connected to an external device.

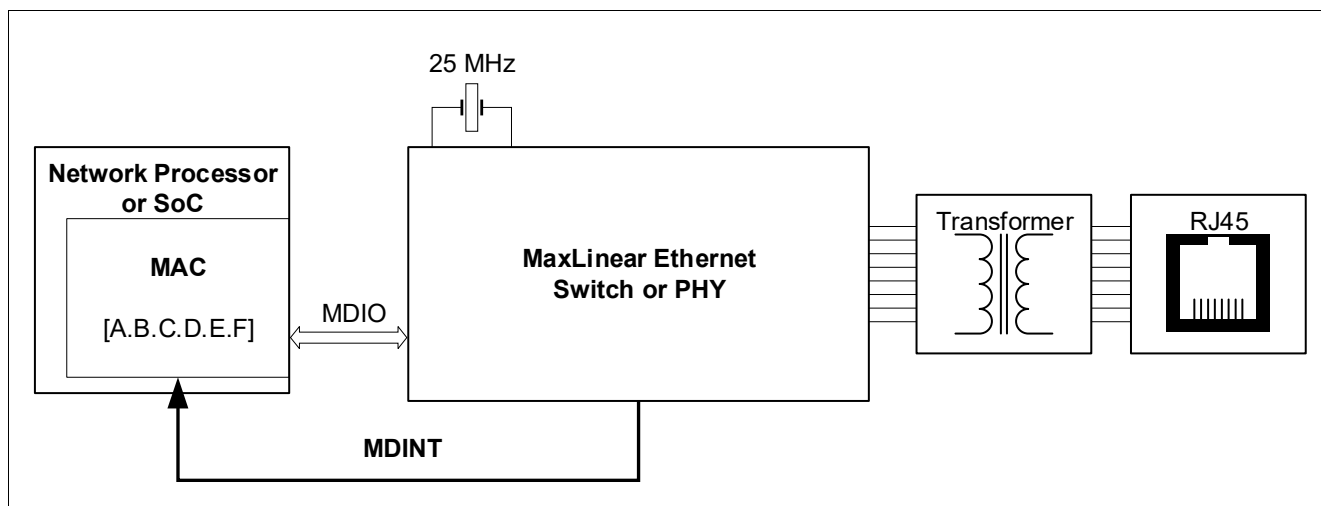

Figure 9 WoL Application Block Diagram

The most commonly used WoL packet is called a magic packet, which contains the MAC address of the device to be woken up, and an optional password called SecureON. The MAC address and the optional SecureON password relevant for the WoL logic inside the MxL86282S are configurable in the WoL MDIO registers in the Vendor Specific 2, VSPEC2 MMD, device described in **Chapter 4**. When such a configured magic packet is received, an interrupt is issued.

Table 23 gives an example programming sequence for these configuration registers.

Table 23 Programming Sequence for the Wake-on-LAN Functionality

Step	Register Access	Remark
1	MDIO.MMD.WOLAD01 = EEFF _H	Programs the fifth and sixth MAC address bytes.
2	MDIO.MMD.WOLAD23 = CCDD _H	Programs the third and fourth MAC address bytes.
3	MDIO.MMD.WOLAD45 = AAB _H	Programs the first and second MAC address bytes.
4	MDIO.MMD.WOLPW01 = 4455 _H	Programs the fifth and sixth SecureON password bytes.
5	MDIO.MMD.WOLPW23 = 2233 _H	Programs the third and fourth SecureON password bytes.
6	MDIO.MMD.WOLPW45 = 0011 _H	Programs the first and second SecureON password bytes.
7	MDIO.PHY.IMASK.WOL = 1 _B	Enables the wake-on-LAN interrupt mask.
8	MDIO.MMD.WOLCTRL.WOL.EN = 1 _B	Enables wake-on-LAN functionality.

3.9 Ethernet SerDes Interface

The MxL86282S implements two Ethernet serial data interfaces. [Table 24](#) lists the data rates supported by the USXGMII interface.

The external PHY is able to initiate clause 37 auto-negotiation to change speed and new link up in SGMII and USXGMII modes.

Table 24 Ethernet SerDes Interface Feature List

Modes	Baudrate	Coding	Link Speed	IEEE Clause	Auto-Negotiation Clause
10G-(K)R/XFI/SFI	10.3125 GT/s	64b/66b	10 Gbps	49	NA
2.5G-(K)X	3.125 GT/s	8b/10b	2.5 Gbps	36	NA
SGMII-1G	1.25 GT/s	8b/10b	1 Gbps, 100 Mbps, and 10 Mbps	36	37
SGMII-2.5G	3.125 GT/s	8b/10b	2.5 Gbps	36	NA
2.5G-SXGMII	2.578125 GT/s	64b/66b	2.5 Gbps, 1 Gbps, 100 Mbps, and 10 Mbps	49	37
10G-SXGMII	10.3125 GT/s	64b/66b	10 Gbps, 5 Gbps, 2.5 Gbps, 1 Gbps, 100 Mbps, and 10 Mbps	49	37

3.9.1 Ethernet SerDes Interface Configuration at Power On

Use a flash or management interface to configure the SerDes interface before bringing the interface up. The FCA, documented in [\[2\]](#), can be used to pre-configure this interface before programming the FW in the flash. For the MDIO-managed mode of operation, the MDIO management interface can also be used to configure this interface via API.

3.10 LED Interface

This section describes the LED interface.

3.10.1 LED

The MxL86282S allows 24 synchronized LEDs to be used for visual status indication. Each LED pin drives either a single color LED or dual color LED.

3.10.2 LED Configuration

The MxL86282S API describing the driver software executed on the Host SoC must be followed to configure this interface. When there is no Host SoC attached, it is possible for the configurations to be done in the FCA [2].

Figure 10 shows the external LED connected to either ground or the power rail in single color mode.

Figure 11 and **Figure 12** show the connection of single and dual color LEDs when the pin is also used for pin strapping.

Note: These figures do not show the full recommended circuits with all the necessary components. Refer to the relevant HDK/EVK PCB design documentation for more details.

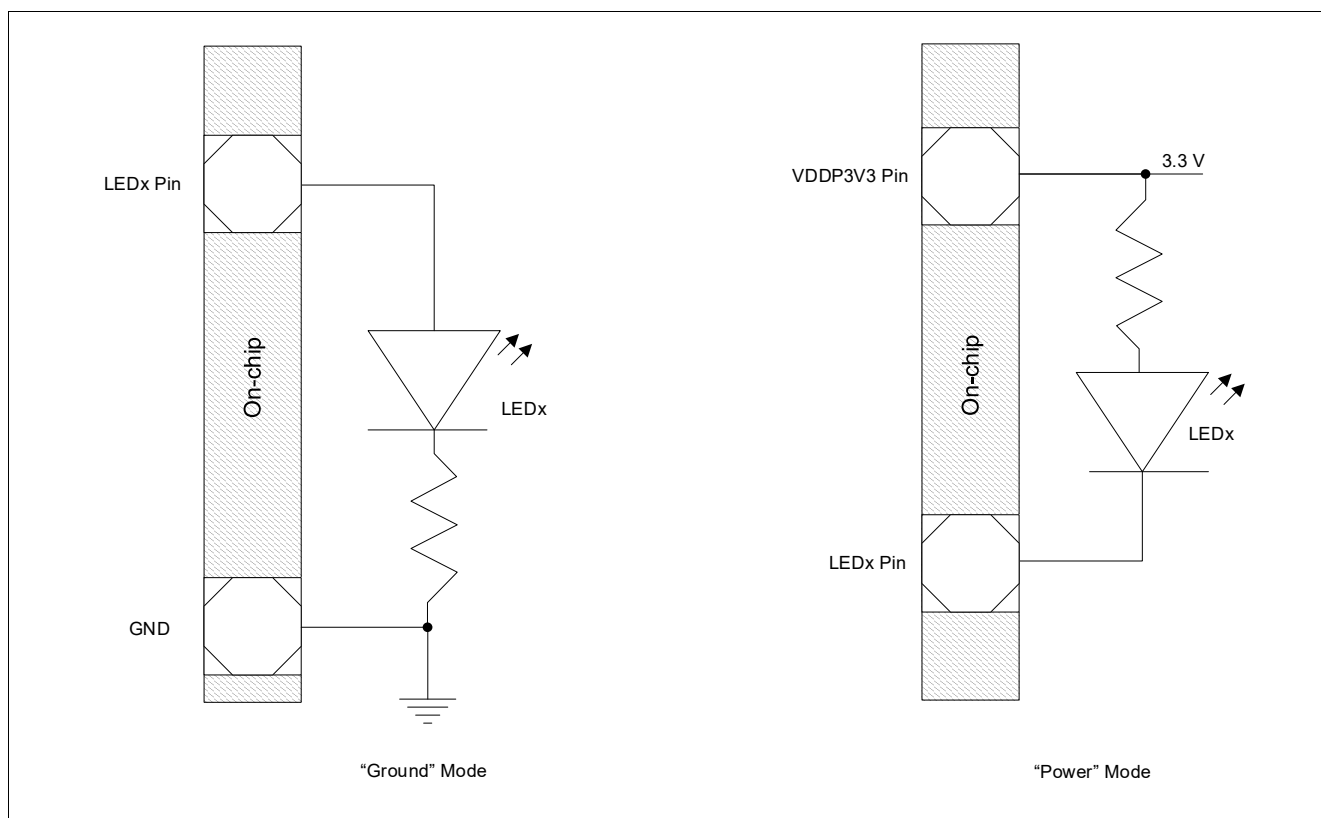

Figure 10 LED Connection Options to Ground or Power Supply

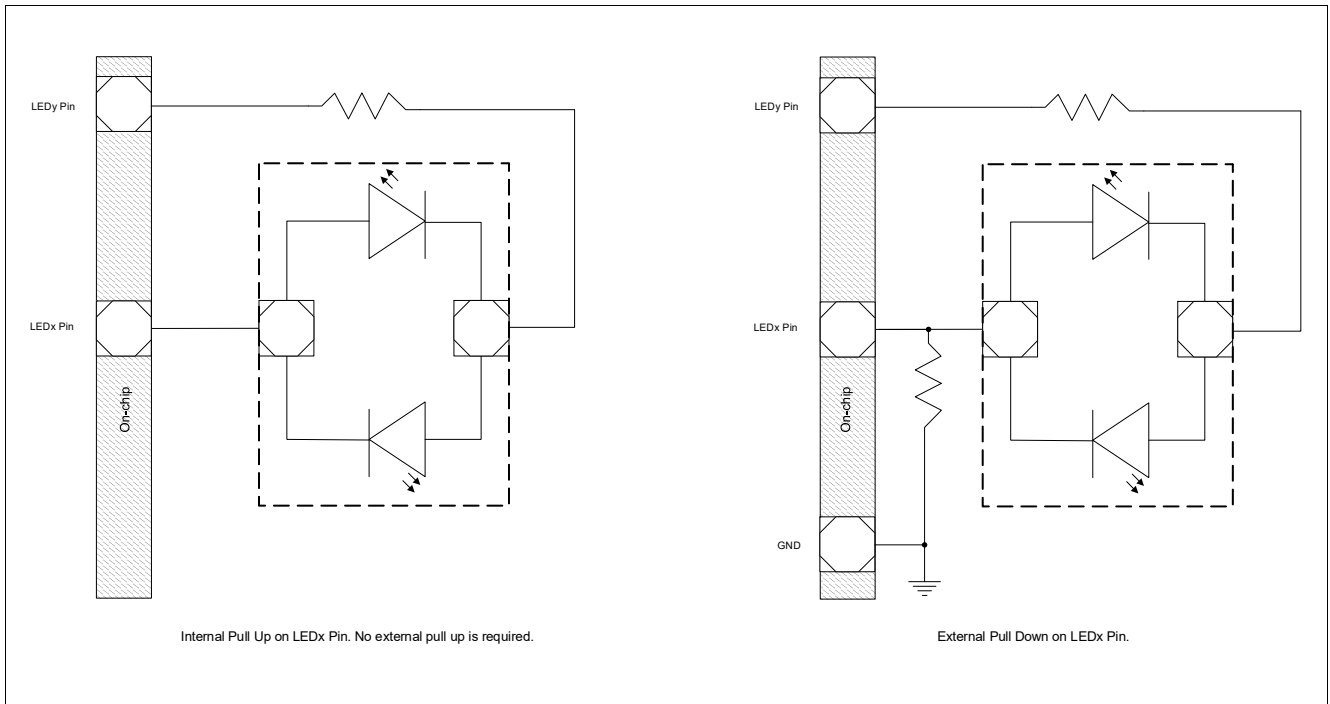

Figure 11 Connection of a Dual Color LED and Configuring Pin Strap Value

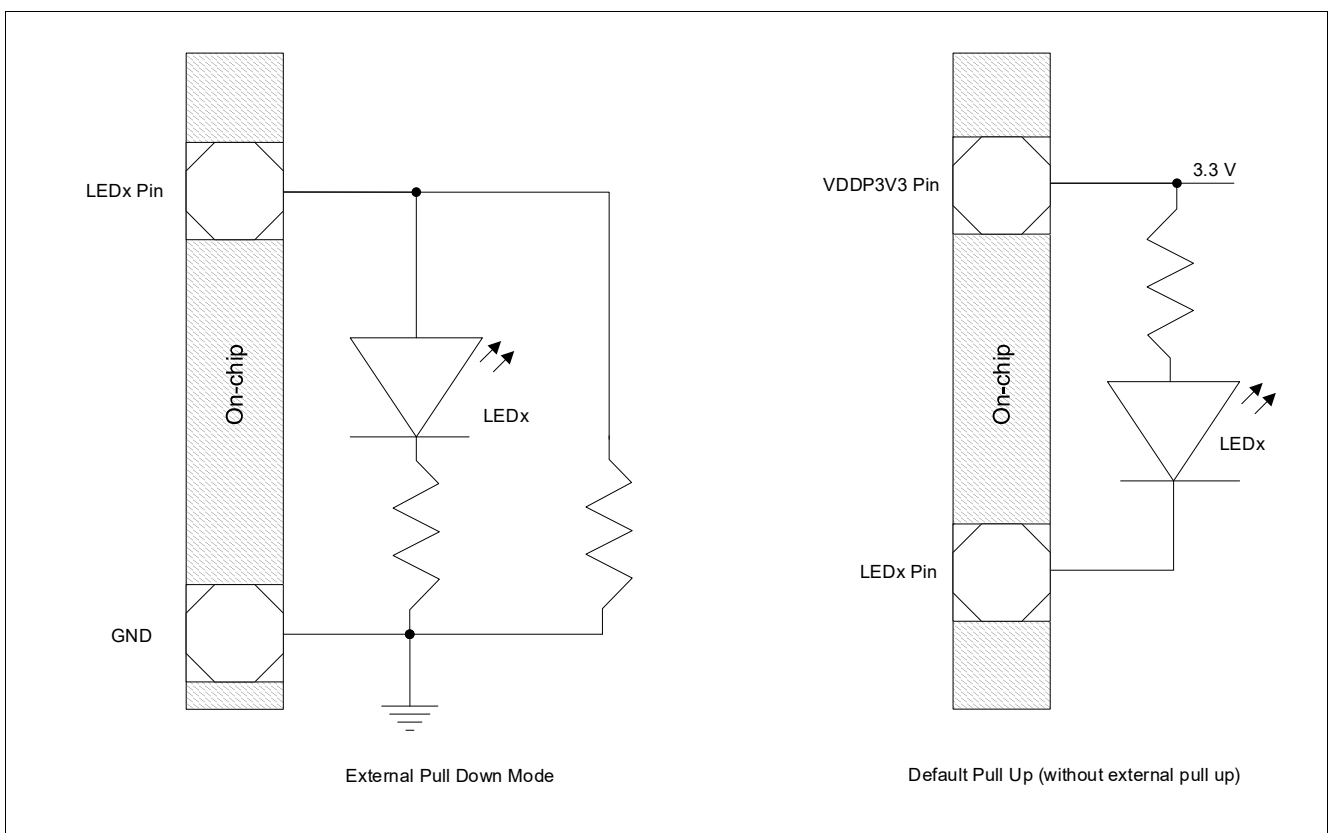

Figure 12 Connection of a Single Color LED and Configuring Pin Strap Value

3.10.3 LED Brightness Control

There are two LED brightness modes configurable by the API for the MDIO-managed mode, or FCA [2] for the smart mode and the unmanaged mode, based on the system requirement.

- LED Brightness Level Maximum Mode
Fixed level signal (no pulses) for maximum brightness, also available as a control signal for other purposes.
- LED Brightness Level Control Mode (Constant Mode)
Allows the configuration of 16 levels of LED brightness. See [Brightness Control](#).

Brightness Control

This block controls the brightness of the LED by controlling the time duration for which the LED is on/off. The persistence characteristic of the eye causes it to perceive this as LED brightness. When LED is off, the output is disabled. When the LED is on, the output is enabled. The brightness control affects the LED output enable directly.

[Figure 13](#) shows the brightness control frequency is 81.25 Hz, where each period is divided into 64 slots.

In the LED brightness level maximum mode, the LED is enabled in all 64 slots, as shown in brightness level 0 which is the maximum brightness.

In the LED brightness level control mode, the LED is enabled for n consecutive slots, where n is determined by the configured brightness level. [Figure 13](#) shows the brightness level in active low mode, whereby brightness level 15 is the minimum brightness.

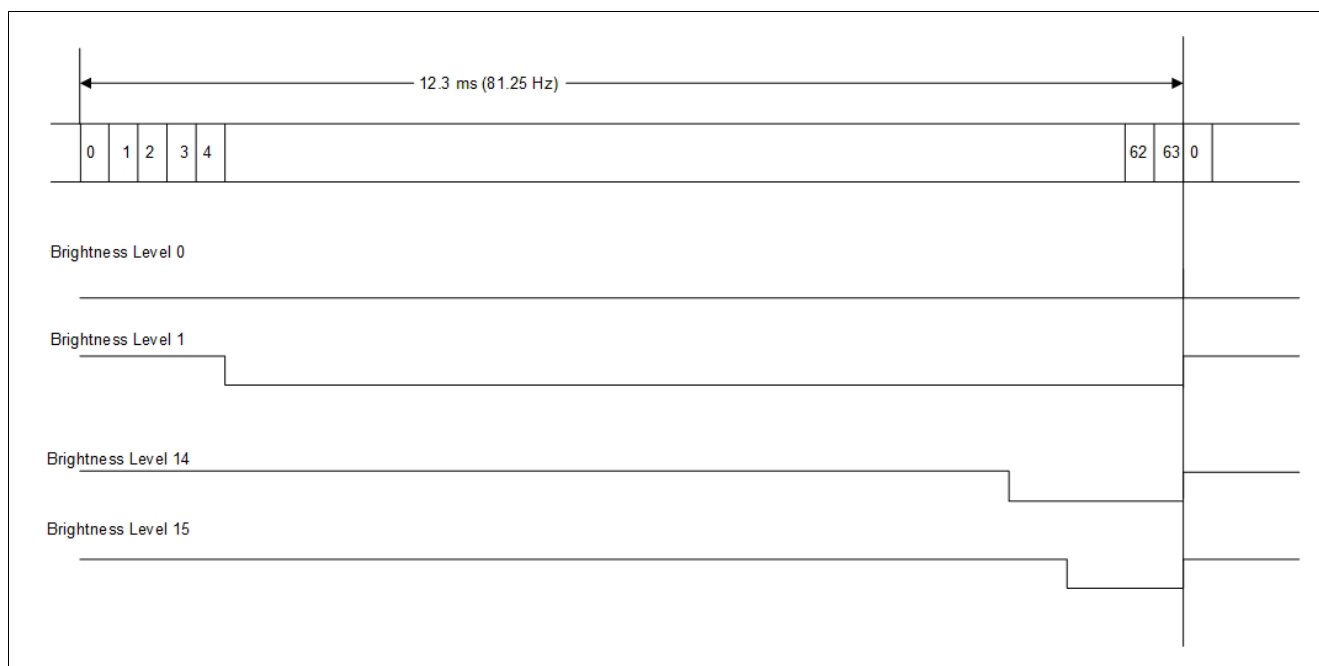

Figure 13 LED Brightness Control by Controlling LED Output Enable/Disable

3.11 Power Management

This section describes the power management functions of the MxL86282S integrated Ethernet PHY.

3.11.1 Power States

Figure 14 illustrates the power states and transitions of each integrated Ethernet PHY.

In this state diagram, the (0.11) syntax corresponds to the value of bit 11 from register 0 in device 0, which is `STD_CTRL.PD`. This is the Power Down (PD) bit in `MDIO STD_CTRL`, described in Chapter 4. The STA is able to use this `STD_CTRL.PD` field to bring the physical interface into the **POWER DOWN State**.

The other states are automatically entered by the MxL86282S depending on the context, and following the EEE protocol. This is done without any intervention from the STA.

The Normal Link Pulse (NLP) and Fast Link Pulse (FLP) are received on the TPI from a link partner and used to wake up the MxL86282S and enter auto-negotiation.

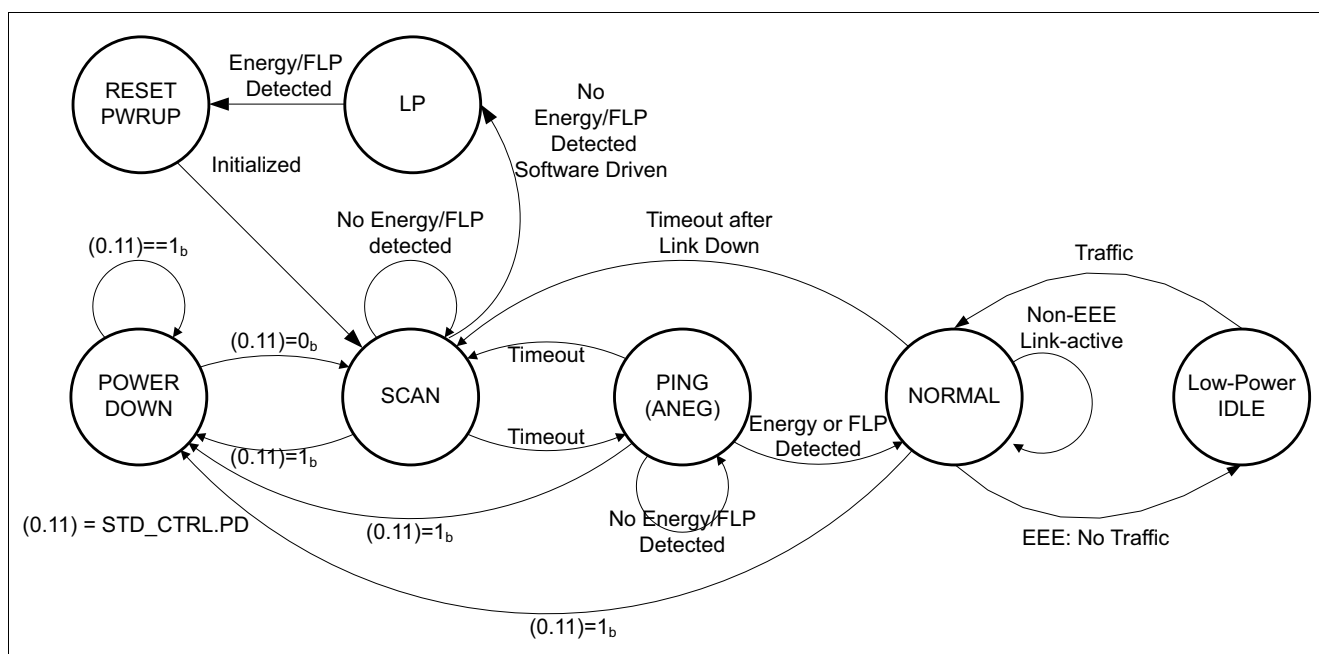

Figure 14 State Diagram for Power Down State Management

3.11.2 RESET PWRUP

The MxL86282S starts up in the RESET Power Up (PWRUP) state after either a hardware reset or power up. After initialization, the PHYs always transition to the **SCAN (ANEG) State**.

3.11.3 POWER DOWN State

The **POWER DOWN State** is entered by setting the PD bit (0.11) of the MDIO standard register `STD_CTRL` to 1, regardless of the current state of the device. The **POWER DOWN State** corresponds to power down as specified in IEEE 802.3, Clause 22.2.4.1.5. Some signal processing blocks are stopped to save energy, but the MxL86282S still responds to MDIO messages.

Exiting the **POWER DOWN State** is triggered by setting the PD bit (0.11) of `STD_CTRL` to 0, which initiates a transition to the **SCAN (ANEG) State**.

3.11.4 SCAN (ANEG) State

The SCAN state differs from the **POWER DOWN State** in that the receiver periodically scans for signal energy or FLP bursts on the TPI. There is no transmission in this state. When an FLP burst is received, the MxL86282S enters the auto-negotiation protocol to exchange capabilities with the link partner and establish a data link in the **NORMAL State**.

3.11.5 PING (ANEG) State

The PING state is similar to the **SCAN (ANEG) State** except that the transceiver transmits an FLP burst onto the TPI for a programmable amount of time. This is used to wake potential link partners from the **POWER DOWN State**. This state corresponds to the state of ANEG described in Clause 28 of the IEEE standard [6].

3.11.6 Low-Power State

The MxL86282S's Low-Power (LP) state is enabled by configuring the MDIO register `PHY_CTL2.LP`. The LP state is entered automatically when there is no Ethernet cable connected to the MxL86282S. The MxL86282S firmware detects this condition when no energy or Link Pulse is present on the TPI and enters the LP state. It is intended to set the MxL86282S into its maximum power saving state. In this state, most digital domains are in reset. Only a minimal amount of circuitry (analog/digital) operates to detect signal energy on the receiver of a TPI and trigger a wake-up.

When the port is in the LP state, the STAs do not have access to the corresponding MDIO/MMD registers.

The LP state is exited upon detection of signal energy on the twisted pair (either NLP or FLP). The port transitions to the **RESET PWRUP** state automatically. The STA host is also able to trigger an LP state exit by applying an API to wake up the specific port that entered the LP state.

It is possible for the STA host to be informed of the LP entry condition. By setting the `PHY_IMASK.LP` bit to ACTIVE, the STA requests the MDINT interrupt from the port when the entry conditions are met. **Figure 15** shows all the LP related control bits and communication mechanism between the STA and the MxL86282S.

It is possible for the STA host to be informed of the LP exit condition. By setting the `VSPEC1_IMASK.CDET` bit to ACTIVE, the STA requests the MDINT interrupt from the port when energy on the link is detected during auto-negotiation. Even when none of the ports are in the LP state, this interrupt is triggered whenever energy is first detected on the link. When the STA triggers the LP state exit via a wake-up request, and there is no energy on the link after the LP state exit, no interrupt is asserted.

Attention: An active-high MDINT in push-pull mode (default is tristate mode) is not supported in the LP mode.

Attention: VSPEC1_IMASK.CDET is not supported in forced speed 10BASE-T/100BASE-TX mode. Auto-negotiation is required to support this feature.

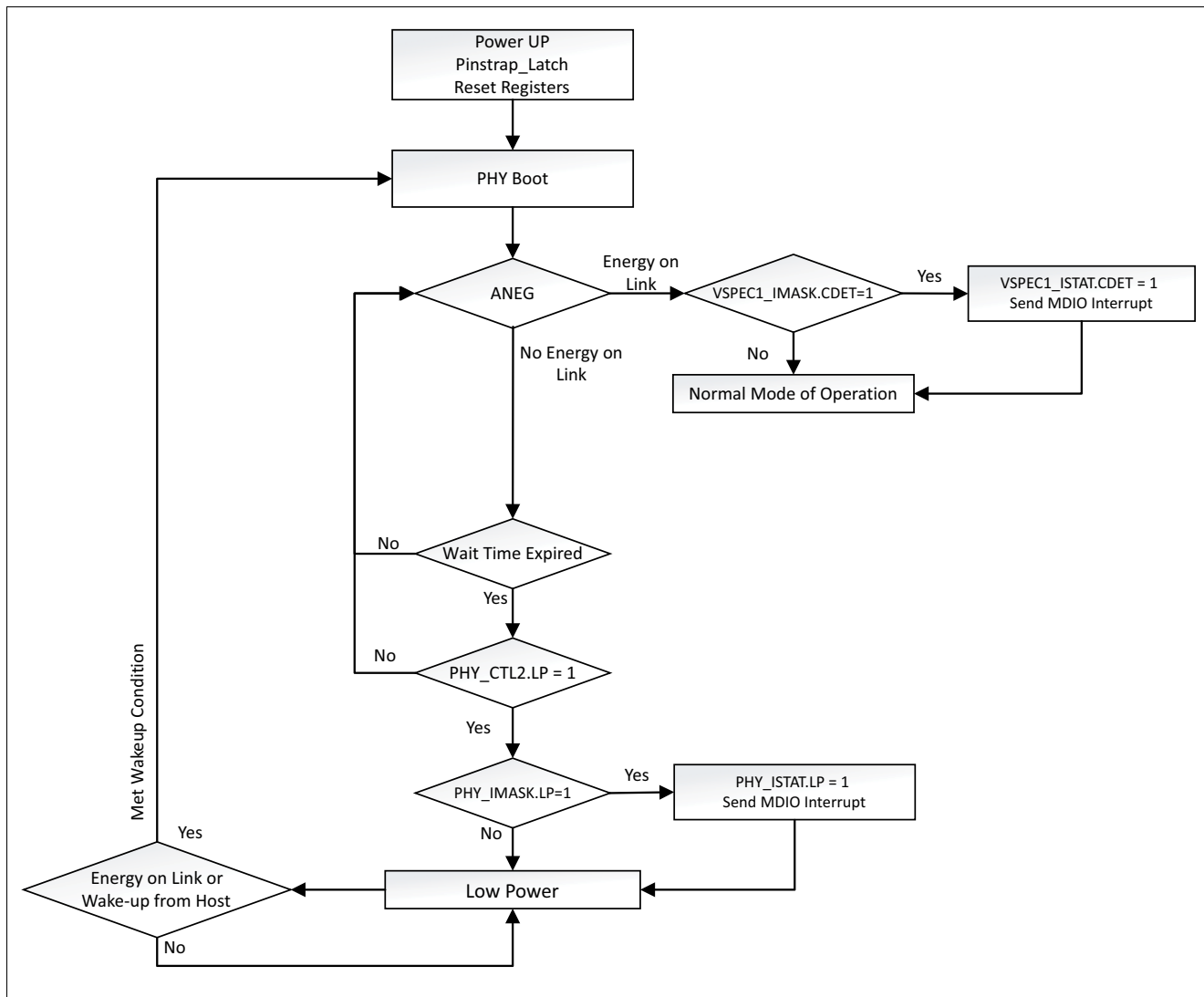

Figure 15 Low Power Sequence

Table 25 Low Power State Entry and Exit Sequence

Step	State	Remark
1	ACTIVE The LP feature is enabled by setting <code>PHY_CTL2.LP = 1</code>	Use the MDIO register <code>PHY_CTL2.LP</code> to enable or disable the LP feature.
2	ANEG, Ability Detect	The firmware detects no energy on the cable when no FLP is received for a long period of time. When the LP feature is not enabled, this time is fixed to between 6.4 and 9.6 seconds. When the LP feature is enabled, this time is configured using the <code>VSPEC1_LOW_POWER_ENTRY_TIME.LPE_TIM</code> register. Time in seconds = 4 x value programmed. Default time is 4 seconds. (<code>VSPEC1_LOW_POWER_ENTRY_TIME.LPE_TIM = 1</code>). There is an initial time of between 2.4 and 5.6 seconds, which adds on to the programmed time.
3	LP Entry Timer	This time is configured with the <code>VSPEC1_LOW_POWER_ENTRY_TIME.LPE_TIM</code> register. The value is set in steps of 4 seconds. The default time is 4 seconds.
4	LP Entry	The MxL86282S saves MDIO LP persistent registers. An interrupt is sent to indicate entry into the LP state.
5	LP State	Power consumption is saved in this state. The MxL86282S listens to energy pulses from the link partner ANEG as a condition to trigger an exit from the LP state. Only a minimal amount of circuitry operates to detect signal energy on TPI and trigger a wake-up. The port LEDs and MDIO interface are disabled.
6	LP Exit (Option 1) Based on energy detected on the cable	The MxL86282S restores the configurations in the MDIO registers. An interrupt is sent to indicate an exit from the LP state.
7	LP Exit (Option 2) Based on a wake-up request from the STA	The STA is able to request an LP exit by using a provided API. The MxL86282S restores the configurations in the MDIO registers. No interrupt is sent to notify LP exit. Not applicable if MxL86282S is not managed via MDIO.
8	ANEG, LINK-UP, and ACTIVE	The MxL86282S operates in normal power modes.

These are persistent MDIO registers saved and restored during LP entry-exit.

1. STD_CTRL.SSM
2. STD_CTRL.DPLX
3. STD_CTRL.ANEN
4. STD_CTRL.SSL
5. STD_AN_ADV.TAF
6. STD_AN_ADV.XNP
7. STD_GCTRL.MBTHD
8. STD_GCTRL.MBTDF
9. STD_GCTRL.MSPT
10. STD_GCTRL.MS
11. STD_GCTRL.MSEN
12. PHY_IMASK
13. PHY_CTL1.AMDIX
14. PHY_CTL1.MDIAB
15. PHY_CTL1.MDICD
16. PHY_CTL1.POLA
17. PHY_CTL1.POLB
18. PHY_CTL1.POLC
19. PHY_CTL1.POLD
20. PHY_CTL2.LPI
21. PHY_CTL2.ANPD
22. PHY_CTL2.PSCL
23. PHY_CTL2.LP
24. PHY_CTL2.STICKY
25. PHY_CTL2.SDETP
26. PHY_LED
27. ANEG_CTRL.ANEG_ENAB
28. ANEG_MGBT_AN_CTRL.LDL
29. ANEG_MGBT_AN_CTRL.FR
30. ANEG_MGBT_AN_CTRL.FR2G5BT
31. ANEG_MGBT_AN_CTRL.AB2G5BT
32. ANEG_MGBT_AN_CTRL.PT
33. ANEG_MGBT_AN_CTRL.MS_MAN_EN
34. ANEG_MGBT_AN_CTRL.MSCV
35. ANEG_EEE_AN_ADV1.EEE_100BTX
36. ANEG_EEE_AN_ADV1.EEE_1000BT
37. ANEG_EEE_AN_ADV2.EEE2G5
38. ANEG_MGBT_AN_CTRL2.THPBYP2G5
39. VSPEC1_NBT_DS_CTRL.NO_NRG_RST
40. VSPEC1_NBT_DS_CTRL.DOWNSHIFTEN
41. VSPEC1_NBT_DS_CTRL.DOWNSHIFT_THR
42. VSPEC1_NBT_DS_CTRL.NRG_RST_CNT
43. VSPEC1_NBT_DS_CTRL.FORCE_RST
44. VSPEC1_LED0
45. VSPEC1_LED1
46. VSPEC1_LED2
47. VSPEC1_PM_CTRL
48. VSPEC1_LOW_POWER_ENTRY_TIME.LPE_TIM
49. VSPEC1_IMASK
50. VSPEC1_FRCTL.CAP_EXT

- 51. VSPEC1_FRCTL.CAP_TXDIS
- 52. VSPEC1_FRCTL.CAP_THPBYP
- 53. VSPEC1_FRCTL.CAP_CISCO
- 54. VSPEC1_FRCTL.CAP_IEEE
- 55. VSPEC1_FRCTL.MAX_FR_RETRY
- 56. VSPEC2_WOL_CTRL
- 57. VPSPEC2_WOL_AD01
- 58. VPSPEC2_WOL_AD23
- 59. VPSPEC2_WOL_AD45
- 60. VPSPEC2_WOL_PW01
- 61. VPSPEC2_WOL_PW23
- 62. VPSPEC2_WOL_PW45

3.11.7 NORMAL State

The NORMAL state is used to establish and maintain a link connection. When a connection is dropped, the MxL86282S moves back into the **SCAN (ANEG) State**.

3.11.8 Low Power IDLE State - Energy-Efficient Ethernet

The IEEE 802.3 standard [6] describes the EEE operation supported by the MxL86282S in the various speeds of 100BASE-TX, 1000BASE-T, and 2.5GBASE-T. The general idea of EEE is to save power during periods of low link utilization. Instead of sending active idle data, the transmitters are switched off for a short period of time. This is called the quiet period. The link is kept active by means of a frequent refresh cycle initiated by the PHY itself while in the low power state. This sequence is repeated until a wake request is generated by one of the link partner MACs. The MxL86282S follows the IEEE 802.3 standard regarding EEE. Figure 16 illustrates the principle. This state is entered automatically when the low power idle conditions are met.

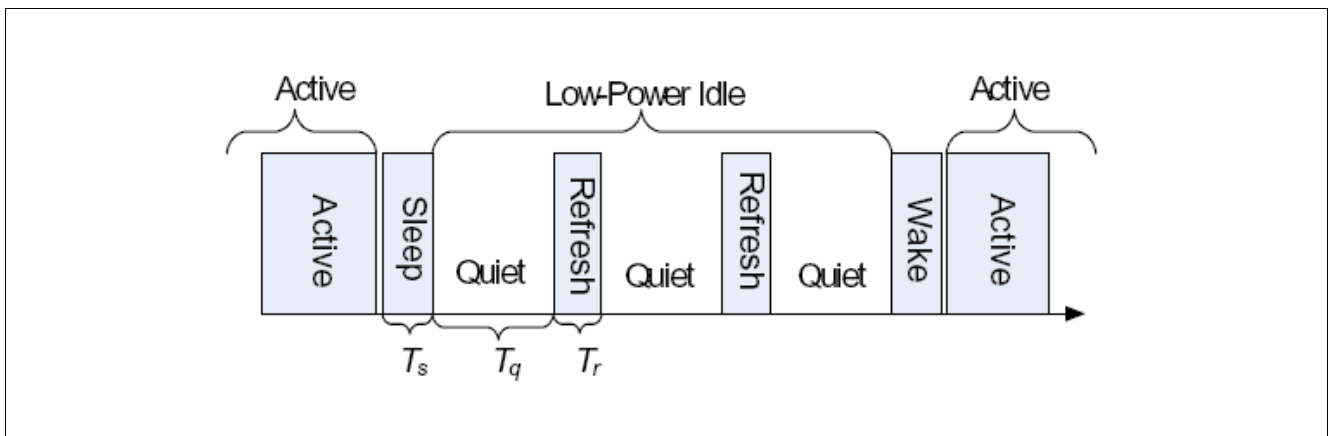

Figure 16 EEE Low Power Idle Sequence

3.12 Firmware Upgrade

The MxL86282S provides a Firmware Upgrade feature that allows feature and functional enhancements of the MxL86282S in the field.

It is possible to download a new firmware image via the MxL86282S's **MDIO Slave Interface** to a serial flash memory device connected to the MxL86282S's QSPI. The MxL86282S is then able to fetch the upgraded firmware from the flash memory after a reboot. The flash memory device must have enough storage for at least two images. The upgrade does not overwrite the original image, but writes to a different location to avoid corrupting the original image.

For the Security Development Lifecycle (SDL) [14] reasons, the MxL86282S only accepts electronically signed firmware images. When authentication of the flash image by the MxL86282S fails during the firmware upgrade process, or the download of the image to the flash memory device is aborted or fails, the MxL86282S defaults to running from the original firmware image in flash memory since there are two images (dual image). The authentication flow is described in the user guide [2].

The supported options for upgrading the firmware image are:

- The firmware is upgradeable over the MDIO slave interface to the flash memory device for MDIO-managed mode.
- When the MxL86282S hosts a web-server as a web-smart switch, the firmware upgrade is done over the web using the webGUI [3].
- In addition firmware download into "empty" flash is supported over MDIO slave interface.

Attention: The MDIO slave interface for firmware download or upgrade supports IEEE 802.3 Clause 22 only.

Attention: The MDIO address for firmware download or upgrade to flash is defined by the pin strapping in Table 17 with the lowest three bits equal to 0.

Attention: After the firmware upgrade to the flash memory is completed, the MxL86282S must be rebooted such that the new image is authenticated. The same requirement also applies to flash memory devices that are programmed directly by customers, which do not use the firmware upgrade procedure provided in this section.

The procedure to download firmware over the MDIO slave interface is documented in [2]. It provides information on the update/download process and which actions are required in the external processor application.

Security features to prevent rollback of the image to a previous version (anti-rollback) and to prevent flash memory wear-out due to frequent updates (flash anti-wear out) are supported within the MxL86282S. The supported features are:

- The MxL86282S verifies that the new firmware has a higher or same security version number (SVN) than the previously installed firmware before executing it. If this step fails due to the firmware SVN being a lower version, the original firmware is executed from the flash memory device since there are two images in the flash memory. If the system does not desire to have this anti-rollback feature, it is possible to disable in the flash configuration. A user guide describing the anti-rollback feature and the configuration option is provided in [2].
- Flash memory components typically support a minimum of 100,000 erase/program cycles, so flash wear-out is unlikely. However, ensuring a minimum interval between flash updates decreases the likelihood of wear-out. If the firmware upgrade is done over the web in a web-smart application, then the MxL86282S is configurable to prevent another firmware update within a certain period of time. For example, when the MxL86282S is configured to insert a wait time of one hour, the minimum time before wearing out the flash memory device becomes longer than 11 years.

However, in a MDIO-managed application, whereby firmware is downloaded to the flash over the slave MDIO interface, the flash anti-wear out feature is not supported by the MxL86282S. The system to which the MxL86282S is attached is expected to ensure that the firmware is only installed when a new firmware is available and does not attempt to install new firmware after every reboot. If the system to which the MxL86282S is attached mandates such features, they must be supported by the system itself.

3.13 Web-Smart Processor

The Web-Smart Processor (WSP) is an integrated microcontroller, which is the central control block inside the MxL86282S for features, such as a web-server. This allows the MxL86282S to be configured via a web-browser on an external device like a PC. Certain levels of customization of the user interface are supported to implement the desired functionality and GUI. A demonstration reference GUI to configure all configurable parameters is also available.

There are 3 WSP firmware security options supported:

1. The provided WSP firmware is signed with a MaxLinear key. The web-server customization is only allowed with the use of configuration files. The scope of such customization is limited. Refer to [4] for information on customizing the web-server and refer to [2] for information on signing the customized firmware. Other configurations using FCA [2] are also supported. This is the default option.
2. The WSP firmware is not signed. This is an option for the customers during their firmware development phase. It allows customers to develop their own firmware faster without needing to compile with a signature. However, the final deployed firmware must be signed with the customer's key using the third option. A separate production flash image is provided to enable this feature. Refer to [2] for more information.
3. The WSP firmware is signed with the customer's key. The production flash image is provided for the customer to write the customer's key into the One-Time-Programmable (OTP) memory in MxL86282S. Refer to [2] for more details on customer's key programming.

The WSP has a 64 KB 4-way instruction cache and executes directly from the external firmware memory. It also has an integrated UART interface that allows console support for development.

3.14 Switch Fabric Functional Description

This section provides a detailed functional description of the Switch Fabric.

3.14.1 Overview

The Switch Fabric is responsible for classifying, storing, and forwarding multiple data packets. It consists of storage buffer, packet queuing, and packet classification units. Ingress data received on one of the interfaces is classified and placed in the appropriate QoS queue in the shared storage buffer. Ingress policing and access control rules are applied to the received traffic and packets not compliant to the rules are discarded. Before a packet is fetched from the shared memory and transmitted on one or several of the egress interfaces, it is subjected to egress scheduling, rate shaping, and modification.

3.14.1.1 Packet Flow

Figure 17 describes a packet data flow through various stages of the switch. The flow starts on the top right corner.

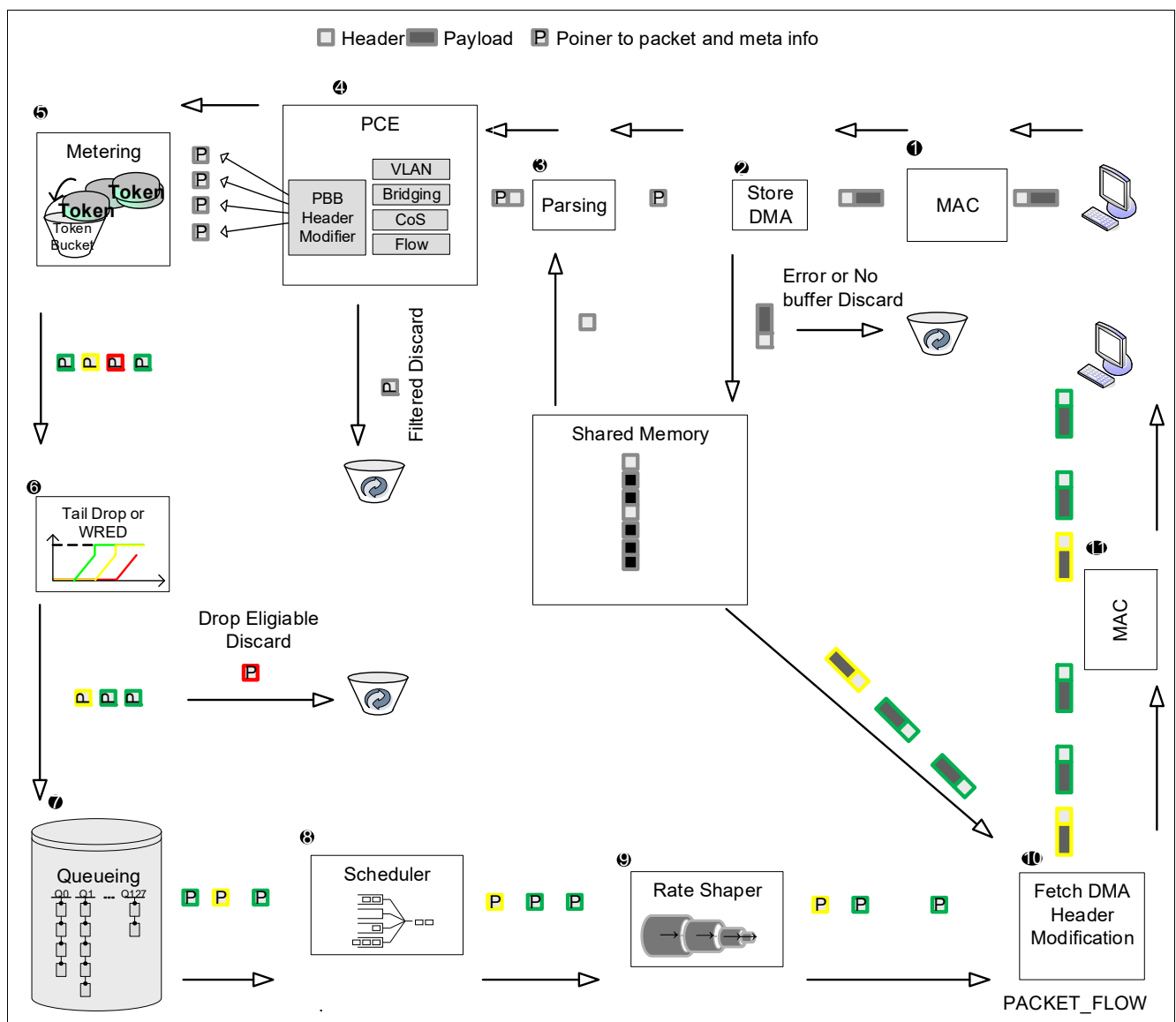

Figure 17 Packet Flow Diagram

The packet received on the ingress interface is first stripped from the Ethernet Preamble and checked for correct CRC. The behavior when a reception error occurs is programmable. This determines whether the packet is discarded or not.

The received packet is classified in the Packet Classification Engine (PCE). The packet is assigned to one or several appropriate QoS queues, such as broadcast or multicast. The packet classification filtering determines whether the received packet is discarded.

Prior to accepting it to a certain queue, the packet is subject to metering and Weighted Random Early Detection (WRED) functions. Packets marked as non-conforming by the metering engine might be discarded by the WRED algorithm based on the configurable drop precedence.

The scheduling function, Strict Priority (SP) and/or Deficit Weighted Round Robin (DWRR), determines which queue is allowed to emit a packet. Prior to transmission on the egress side, the packet is subject to Rate Shaping. Packets scheduled for transmission are subject to egress specific header modification, such as, MAC address swap, special tag modification, OAM timer stamp modification, OAM packet counter field modification, DSCP and IP checksum modification, or VLAN tag modification.

3.14.1.2 Switch Fabric Control

For applications with MDIO-managed mode of operation, the switch fabric on the MxL86282S is controlled by a switch driver executed on the Host SoC. The control interface is the slave MDIO interface. The same interface is used to configure the PHY MDIO and MMD registers using the switch driver. The switch driver is part of the Host SoC API software documented in the MxL86282S API.

In applications with smart mode of operation, where it is not managed by the Host SoC, the switch is controlled via the webGUI, documented in [\[3\]](#).

In unmanaged mode, the switch fabric is pre-configured using the FCA, documented in [\[2\]](#).

3.14.2 Ethernet Bridging

Ethernet bridging, or switching, is the primary task of the switch macro. The frames received on one of the ingress ports must be forwarded to the appropriate destination port. The destination port is determined by a lookup in the MAC bridging table. The MAC bridging table can be populated by software, using static entries, or entries can automatically be learned by the hardware learning function. The entries learned by the hardware can age out after a configurable time and are deleted from the MAC bridging table.

3.14.2.1 Parsing

The switch macro features a parser realized as a microcoded engine. This allows a flexible adaptation to any future protocol changes. The parser microcode evaluates the frame header and is capable of extracting all relevant information up to the layer 4 protocol from the frame. The microcode must be loaded otherwise only the MAC destination and MAC source address is extracted from the frame.

3.14.2.2 MAC Bridging Table

The MAC bridging table is realized as a hash table with four collision buckets and holds these components.

- Lookup key
 - MAC address
 - Forwarding identifier (FID)
 - VLAN tag
- Control information
 - Static indication
 - Aging timer
 - Changed indication
- Result
 - Port or port map
 - Sub-interface ID
 - Associated MAC address

A port map is a bitmap where each bit represents a single port. The port map allows to send the frame to multiple destination ports and is available for static entries only.

The switch macro supports learning, either Shared VLAN Learning (SVL), or Independent VLAN Learning (IVL). It is achieved by mapping the default customer VLAN ID or a flow to an FID used as part of the lookup key, together with the MAC address, for the MAC bridging table lookup. By default, the FID value is zero and all entries belong to SVL.

Entries are entered automatically by hardware using dynamic MAC address learning, or entered by software via manual learning. The software writes static entries into the MAC bridge table, but it is also possible to write dynamic entries which are subject to aging.

The MAC bridge table is able to hold unicast, multicast, or broadcast addresses. The table entries containing multiple egress ports as a destination are entered only as static entries by appropriate management action.

3.14.2.3 Layer 2 Security

The supported layer 2 security features comprise:

- IEEE 802.1X
- MAC learning limitation, allows only a limited number of MAC addresses to be learned on a port.
- MAC port locking and MAC spoofing detection, allows only frames with a previously learned MAC and PortID association.
- MAC table freeze, allows only frames with previously learned MAC addresses.
- Source MAC address filtering and destination MAC address filtering, filters user defined MAC addresses.

3.14.2.4 Spanning Tree Protocol Support

The switch macro supports the port states required for the Spanning Tree Protocol (STP) functionality. 16 spanning tree instances per port are supported. Each spanning tree instance is associated with least significant 4 bits of the FID and a port. The port state programmed for one FID does not have effect on the behavior of another FID of the same port.

These states are supported per STP instance:

- **Disabled**
When disabled, all ingress frames are dropped, the source MAC address is not learned. All egress frames are discarded.
- **Blocking/Listening**
In this state, all regular ingress and egress traffic is discarded. It is possible for Bridge Protocol Data Unit (BPDU) frames to ignore the port state and be forwarded to the STP managing entity. The source MAC address is not learned in this state.
- **Learning**
In this state, all regular ingress and egress traffic is discarded. The source MAC address is learned in this state. It is possible for BPDU frames to ignore the port state and be forwarded to the STP managing entity.
- **Forwarding**
Normal operation. Ingress and egress traffic is enabled for all frames.

3.14.2.5 Flow Control Function

To prevent buffer congestion and packet drop, the switch macro supports a flow control mechanism. In full duplex operation the sender is notified to start or stop the transmission via a PAUSE frame based on the IEEE 802.3x standard or a priority pause frame based on the IEEE 802.1Qbb standard. The switch macro is able to transmit or receive and react accordingly to 802.3x/802.1Qbb flow control frames. In half duplex operation, the switch macro supports a back pressure mechanism, specifically, a jam pattern is transmitted on the port forcing a collision. It is possible to enable or disable flow control on a per-port basis. When enabled, it depends on the auto-negotiation result of the attached PHY.

This list shows how flow control is applied:

- **Global Flow Control**
Flow control is activated when the global buffer congestion level exceeds a programmable global threshold and is deactivated when the global buffer congestion level is below a programmable global threshold. Flow control applies to all enabled ports.
- **Ingress Port Congestion-Based Flow Control**
Flow control is activated when the ingress port local buffer congestion level exceeds a programmable local threshold and deactivated when the local buffer congestion level drops below a programmable local threshold. Flow control applies to each port individually.
- **Ingress Port Metering-Based Flow Control**
When the global buffer filling level exceeds a programmable global threshold, flow control is activated on the port that exceed the configured ingress rate. When the global buffer filling level drops below a programmable threshold or the traffic rate is reduced below the configured rate, flow control is deactivated on the port. See [Section 3.14.5.4](#) for details regarding the metering based flow control and metering assignment.

3.14.2.6 Port Trunking Functions

The switch macro supports link aggregation according to IEEE 802.3ad. Link aggregation (LAG), also called port trunking, allows to combine multiple physical ports to a trunk for high bandwidth inter-switch links. It is possible to combine 64 physical ports to form a trunk, which is also known as a LAG group. There is no restriction on the port sequence or combination which are used for the trunk. When one link is broken or disabled for any reason, such as being powered off, the software or firmware detects and automatically reconfigures the mapping. It is not

possible for hardware to automatically switch to other working links. Up to 32 LAG groups are supported. The number of physical ports in a LAG group is not required to be a power of 2.

Figure 18 shows how packets received from all ports in a trunk are aggregated and how the packets are distributed to all ports in a trunk.

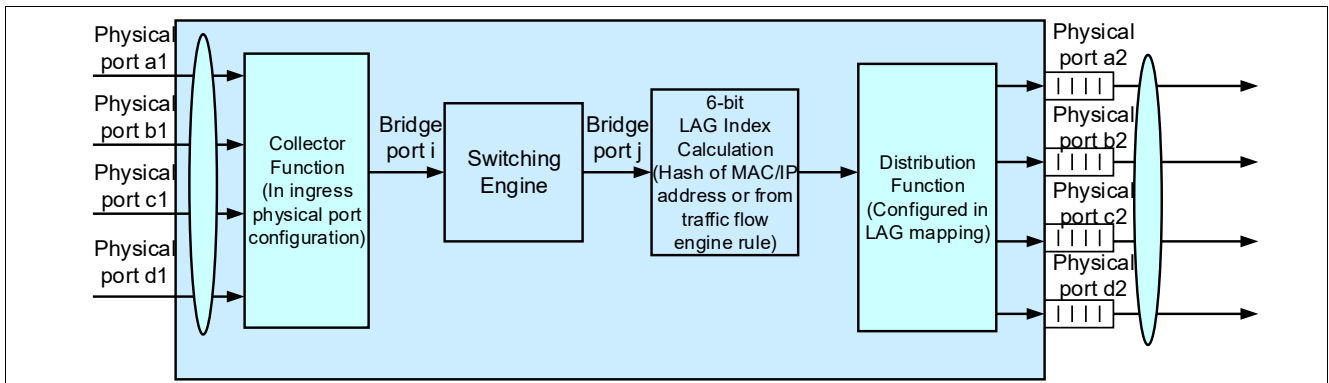

Figure 18 Port Trunking Function

3.14.3 VLAN Functions

This section describes Virtual Local Area Network (VLAN) bridging functionality.

A VLAN is a grouping of network devices logically segmented by functions or applications without regard to the physical location of the devices. Ports in a VLAN share broadcast traffic and belong to the same broadcast domain. Any traffic in one VLAN is by definition not transmitted outside of that VLAN. However, there are exceptions to this general rule which are configurable to cover certain system requirements.

This section provides more details regarding VLAN functionality.

3.14.3.1 VLAN Association

The VLAN classification function associates each packet received on the ingress side with a specific VLAN group. VLAN association is performed in one of two ways:

- **Implicit VLAN Association**

The VLAN group is based on packet attributes. When the association is based on the ingress port it is called port-based VLAN. When the association is based on the MAC address, it is referred to as a MAC-based VLAN. When the association is based on selected packet header fields, such as Ethernet type, IP protocol, IP address subnet, or MAC address, it is referred to as a protocol-based VLAN.

- **Explicit VLAN Association**

The VLAN group information is carried in a VLAN tag in the Ethernet header of the received packet. This association is referred to as a tag-based VLAN.

3.14.3.2 VLAN QinQ

IEEE 802.1QinQ is an Ethernet networking standard formally known as IEEE 802.1ad and is defined in the amendment IEEE 802.1Q-1998. It is for Ethernet frame formats. The technique is also known as provider bridging, stacked VLANs, QinQ, or Q-in-Q. The idea is to provide, for example, the possibility for customers to run their own VLANs inside service provider's provided VLAN. This allows a service provider to configure a single VLAN for a customer and allowing each customer to treat that VLAN as if it were a trunk.

The original 802.1Q specification allows a single VLAN header to be inserted into an Ethernet frame. QinQ allows multiple VLAN headers to be inserted into a single frame.

In this context, a QinQ frame is a frame that has two VLAN 802.1Q headers, and is referred to as a being double-tagged. A tag stack creates a mechanism for internet service providers to encapsulate customer-tagged 802.1Q traffic with service provider's tag. The final frame is a QinQ frame.

A Service VLAN Tag (STAG) frame is identified by a Tag Protocol ID (TPID), which is typically 88A8_H, but is programmable, and is followed by two bytes of the Tag Control Information (TCI) field. The TCI field consists of a 3-bit Priority Code Point (PCP) field, a 1-bit Drop Eligible Indicator (DEI) field, and a 12-bit VLAN Identifier (VID) field.

A Customer VLAN Tag (CTAG) frame is identified by a TPID, typically 8100_H, but is programmable, and is followed by two bytes of the TCI field. The TCI field consists of a 3-bit PCP field, a 1-bit DEI field, and a 12-bit VID field.

VLAN QinQ is supported with the extended VLAN tagging operation.

3.14.3.3 Extended VLAN Tagging Operation

Extended VLAN tagging operation is supported with a 1K entry table. Both symmetrical and asymmetrical ingress and egress tagging is supported, whereby the start and the end entry index are programmable per ingress port and per egress port independently. It is possible to cascade the ingress and egress extended VLAN tagging operation.

There are two parts in each entry: the filtering pattern and the action. The filtering pattern includes VLAN priority, VLAN ID, TPID/DEI of both STAG and CTAG and the Ethertype. It is configurable to base on the intermediate

VLAN tags, after modification in the previous processing stage, or the original ingress VLAN tags, before any modification, per entry.

The actions of the tagging operation corresponding to each matched rule includes the discard/forwarding action, STAG and CTAG removal/insertion/replacement, DSCP remarking, traffic class assignment, bridge port reassignment, metering assignment, mirroring enable/disable, loop-back enable with DA/SA swap.

It is only possible to insert, remove, or replace two VLAN tags. If both an ingress extended VLAN tagging operation and an egress extended VLAN tagging operation are enabled, any configuration which requires the insertion/removal/replace of more than two VLAN tags is illegal.

Discarded packets by ingress extended VLAN tagging operation are trappable by traffic flow classification engine for forwarding. When cross-VLAN is enabled, discard actions by the extended VLAN tagging operation are ignored.

3.14.3.4 VLAN Filtering

It is possible to forward or discard a received frame based on the VLAN group configuration and configured port attributes. VLAN filtering is based on the STAG VLAN TCI, after it has been modified in a previous processing stage. The filtering is applicable to all ingress ports, after the ingress extended VLAN tagging operation, and egress ports, before egress extended VLAN tagging operation. Both symmetrical and asymmetrical VLAN filtering are supported.

The VLAN TCI field comprises the VLAN ID, PCP and DEI field. These VLAN filtering mask options are supported in ingress and egress port configuration:

- **VID-Only Mode**
In VID-only mode, the VLAN ID field is used for VLAN filtering lookup.
- **PCP-Only Mode**
In PCP-only mode, the PCP field is used for VLAN filtering lookup.
- **TCI Mode**
In TCI mode, all 16-bit TCI is used for VLAN filtering lookup.

It is possible to configure the VLAN rules to discard or forward VLAN-tagged traffic which does not match any of the three filtering rules. For VLAN untagged traffic, it can be configured to be discarded or forwarded.

It is possible to configure each ingress port to filter according to a list of different TCI or mask patterns. Each egress port supports up to 2 such lists. These lists are sharable between ports and contain up to 1,000 TCI or mask patterns.

3.14.3.5 VLAN Transparent Mode

VLAN transparent mode is configurable per ingress port.

If VLAN transparent mode is enabled, VLAN tags at ingress are treated as part of the payload and the packets are considered as untagged.

Several exceptions apply to VLAN transparent mode, they are:

- **Traffic Flow Classification - Ingress VLAN ID**
Transparent mode is ignored when the pattern field of a VLAN is based on the ingress VLAN ID. The ingress-tagged packets are still considered as tagged packets regardless of transparent mode setting.
- **Traffic Flow Classification - STAG PCP+DEI and CTAG PCP+DEI**
Transparent mode is ignored when STAG PCP+DEI and CTAG PCP+DEI is based on ingress packets. The ingress-tagged packets are still considered as tagged packets regardless of the transparent mode setting.
- **Traffic Class Mapping**
PCP+DEI in ingress STAG and PCP in ingress CTAG are used for traffic class mapping regardless of transparent mode setting.

3.14.3.6 Cross-VLAN Functionality

Ethernet frames that are classified as cross-VLAN cross the VLAN boundaries. They ignore any of the VLAN filtering modes for the ingress or egress ports, and any discard action in the extended VLAN tagging operation for the ingress or egress ports.

Cross-VLAN classification is performed as part of the traffic flow classification function.

3.14.4 Multicast Forwarding Functions

Multicast forwarding is a method of forwarding Ethernet frames or IP datagrams to a group of receivers. A basic Ethernet switch floods all received multicast frames to all output ports even when no host on a port is interested in that particular multicast stream. This waste of bandwidth is avoided by the sophisticated multicast handling of the switch macro which allows the forwarding of multicast frames based on layer 2 or layer 3 addresses to dedicated ports. In addition, the switch macro is able to learn layer 3 multicast group addresses via IGMPv1/2/3 and MLDv1/2 snooping.

3.14.4.1 Layer 2 Multicast Forwarding

The layer 2 multicast forwarding function deals with multicast frame forwarding based on the Ethernet MAC address. The destination port map is looked up in the bridging table. The multicast addresses are not added to the bridging table by automatic learning function and must be configured manually, by an appropriate management action. The associated port map contains all the relevant port members. When the destination MAC address of the received frame matches the entry in the bridging table and the forwarding mode is layer 2 only or there was no match in the layer 3 multicast table, or the packet is non-IP multicast, the frame is delivered to all the destinations specified in the associated port map.

3.14.4.2 Layer 3 Multicast Forwarding

The layer 3 multicast function deals with multicast frame forwarding based on the IPv4 or IPv6 network address. The destination port map is looked up in the layer 3 multicast table.

The lookup in the multicast table is performed using the destination IPv4/IPv6 address, the source IPv4/IPv6 address, and FID. The addresses in the table are added by an appropriate management action.

3.14.4.3 IGMP and MLD Snooping

The switch macro supports Internet Group Management Protocol (IGMP) and Multicast Listener Discovery (MLD) snooping. IGMP/MLD snooping is designed to prevent hosts on a local network from receiving traffic for a multicast group they have not explicitly joined. It provides a mechanism to prune multicast traffic from links that do not contain a multicast listener, which is an IGMP/MLD group member. IGMP/MLD snooping requires the switch macro to examine, or snoop, some layer 3 information in the IGMP/MLD packets sent between the hosts and the router. In addition, adjacent routers also use these protocols to communicate and share routing information. It is also possible to snoop the exchange information to identify the multicast router port.

The switch macro supports software-based IGMP/MLD snooping mode for the IGMPv1/2/3 or MLDv1/2 protocols. In this mode, specific IGMP/MLD reports can be intercepted by the switch and delivered to the CPU or network processor port. The reports are analyzed by the CPU and the layer 3 multicast table is populated by the software with appropriate source or destination addresses.

3.14.5 Quality of Service Functions

The switch macro provides extensive support for Quality of Service functionality. Traffic class assignment based on multiple flow parameters, ingress traffic policing, multiple egress queues per port with strict or WFQ scheduling, traffic shaping, and Weighted Random Early Detection (WRED) functions are supported.

This section describes the QoS functions supported by the switch.

3.14.5.1 Class of Service Assignment

The switch macro supports classification of the incoming traffic into traffic classes or classes of service (CoS). It is possible to manage each traffic class differently, be it remarked, policed, or shaped, ensuring preferential treatment for higher-priority traffic on the network. Supported RFCs include RFC2474 and RFC2597.

Up to 16 different traffic classes are supported and mapped individually to appropriate QoS queue. See [Section 3.14.5.3](#) for more details regarding queue mapping.

3.14.5.2 Remarking Function

The switch macro supports the remarking of the Differentiated Services Code Point (DSCP), the (re)generation of the STAG PCP&DEI, and the (re)generation of the CTAG PCP&DEI in the egress frame. The modification of the code points in the outgoing packets is based on both traffic class and egress port. The switch macro provides a dedicated mapping table to assign the new DSCP, CTAG PCP&DEI, and STAG PCP&DEI according to traffic class, as well as the egress port. [Figure 19](#) shows how to remark DSCP, including drop precedence, CTAG PCP, CTAG DEI, STAG PCP, and STAG DEI based on any of the class of service assignment parameters.

Remarking is enabled on a per ingress port basis. It is also possible to disable remarking on a per egress port and per code point basis. In addition, the traffic flow table allows disabling remarking explicitly for certain flows.

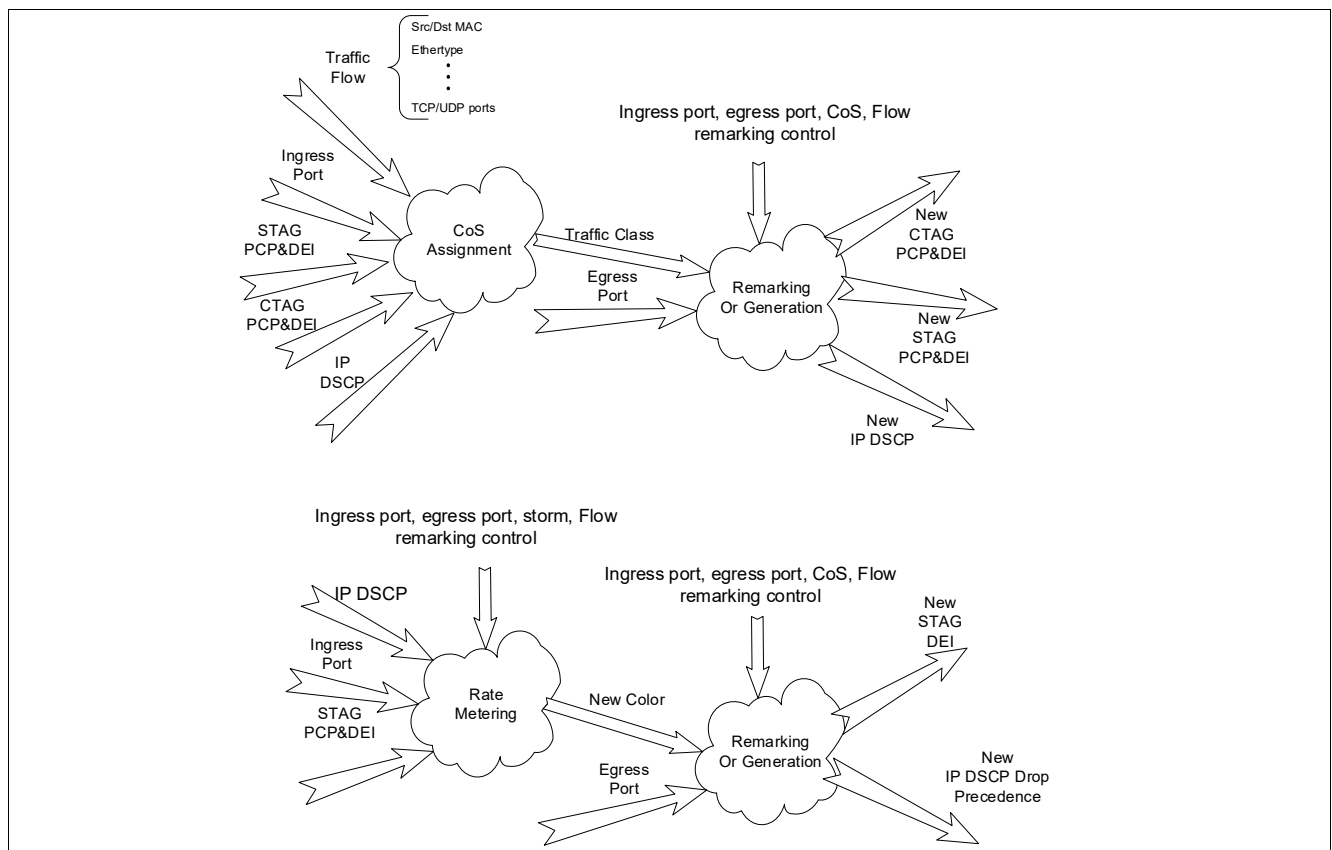

Figure 19 PCP/DSCP/DEI Remarking

3.14.5.3 Queue Mapping

The switch macro supports 128 egress QoS queues which are flexibly assignable to egress ports and traffic classes. For each egress physical port, up to 16 priority queues are assignable. This section provides more details about the queue mapping functionality.

Queue to Port Mapping

By default, each egress port has 8 QoS queues. Depending upon application, it might be desirable to have a different number of QoS queues on specific ports. The switch macro supports flexible queue to port mapping, assuming that the queues assigned to one egress physical port are consecutive and the total number of queues per port do not exceed 16. This way the default configuration can be changed so that one port, for example, contains 16 queues.

In addition, an active port must have at least one queue and can have maximum 16 queues assigned to it.

Port, Traffic Class to Queue Mapping

Incoming frames are being stored in the appropriate queues based on the egress port and the traffic class assignment. The mapping of the traffic class to queue is specified in a dedicated queue mapping table per egress port. The mapping of the traffic classes to queues is related to the number of the queues available on a certain port. For example, on one port, four traffic classes are mappable to four different queues, while on another port, all four traffic classes are mappable to one single queue.

3.14.5.4 Rate Metering

The switch macro supports 128 instances of a Two Rate Three Color Marker (trTCM) rate metering. Each marker or meter measures the rate of a packet stream and marks the packets as green, yellow, or red. When there is no metering instance assigned to a traffic stream, the stream is considered to be green and in color-blind mode. In color-aware mode, the stream is colored based on the drop precedence encoded in the frame.

It is possible to use the color markings later for policing in the active congestion management function, see [Section 3.14.5.7](#) for details. In addition, the markings are usable to remark the drop precedence of the outgoing packet in the DSCP and STAG DEI.

The supported metering algorithm in Single Rate Three Color Marker (srTCM) is defined in RFC2697. The supported metering algorithm in trTCM are the non-coupling mode as defined in RFC4115 and the coupling mode as defined in the Metro Ethernet Forum (MEF). It is only possible to assign a single meter instance to measure the rate of a traffic flow.

Critical Frames

Frames are classified as critical based on a rule configured in the traffic flow table. Critical frames bypass the metering instance and do not trigger the active congestion management function.

Color-aware and Color-blind Modes

The switch macro supports color-awareness modes which are configurable per ingress port. In color-aware mode, the meter assumes that some preceding entity has pre-colored the incoming packet stream so that each packet is either green, yellow, or red. The ingress color of the incoming frame is based on either DSCP value or STAG PCP&DEI value. It is retrieved from the appropriate DSCP mapping table or STAG PCP&DEI mapping table. Non-IP and non-STAG packets are treated as pre-colored to green.

In color-blind mode, all packets are treated as green.

DSCP Drop Precedence Remarking

DSCP drop precedence remarking is enableable in both the ingress port configuration and the egress port configuration by replacing the lower three bits of the received DSCP field with the value of appropriate color

decided by the metering instance for the received packet. The mapping of the color to the lower three bits of the DSCP is configurable per egress port. See [Section 3.14.5.2](#) for details.

DEI (Re)generation

DEI regeneration is enabled by both ingress port and egress port configuration to reflect the metering result by setting the STAG DEI field of the packet with the value of appropriate color decided by the metering instance for the received packet. The mapping of the color to the DEI is configured per egress port. See [Section 3.14.5.2](#) for details.

Metering-based Flow Control

When a metering instance is assigned to an ingress port, the conformance rate of the port is usable for triggering flow control. See [Section 3.14.2.5](#) for details.

3.14.5.5 Rate Shaping

The switch macro supports 128 instances of rate shaper instances. Each rate shaper is configurable to either token bucket mode or credit rate shaper mode. Each shaper measures the rate of an egress queue and prevent the queues which exceeded the configured rate from being scheduled for the next packet transmission. Shaping is based on a Committed Information Rate (CIR) and an associated Committed Burst Size (CBS). A queue is selectable for transmission only when it does not exceed the CBS for a given CIR.

Up to two shaping instances can be assigned to measure the egress rate of a specific queue or number of queues. Two shapers are typically assigned to measure the peak and committed rate and typically have different CIR settings. It is possible for any number of queues to share the same shaping instance. In this situation, the committed rate and the burst size are shared among the assigned queues.

When there is no shaper assigned to a queue, the queue rate is not monitored. MaxLinear recommends assigning a shaper for queues with high scheduling weights or strict priority queues. See [Section 3.14.5.6](#) for details regarding queue scheduling.

3.14.5.6 Queue Scheduling

The scheduling function determines which queue is allowed to emit a packet. Queue scheduling is done after rate shaping. The switch macro supports these scheduling types for each one of the 128 egress QoS queues:

- **Weighted Fair Queueing (WFQ)**
For a given port, packets in the WFQ queues are scheduled for transmission in accordance with their configured weight. The weight represents a ratio for transmission. The higher the weight of one queue compared to another, the more this queue is scheduled for transmission.
For example, a queue with a weight of 4000 is served twice as often than a queue with a weight of 2000.
- **Strict High Priority**
For a given port, packets in the strict high priority queue are scheduled for transmission before any packet in the WFQ queue. When there are multiple strict high priority queues configured for a port, the queues with a higher physical number are scheduled first.
- **Strict Low Priority**
For a given port, packets in the strict low priority queue are scheduled for transmission after any packet in the WFQ queue. When there are multiple strict low priority queues configured for a port, the queues with a higher physical number are scheduled first.

3.14.5.7 Congestion Management

The switch macro provides protection for the internal buffer from congestion and overflow.

When the shared buffer is fully occupied and does not have enough resources to receive any new frame, the incoming frames on all ports are discarded, until the congestion condition is relieved. See [Section 3.14.2.5](#) for flow control activation.

The switch macro also provides two segment thresholds per color globally and per color per egress queue. For every incoming packet, a decision is made whether to enqueue it or not, which is based on the configured thresholds of the respective packet color, and the global, port or queue segment filling level. This protection mechanism is called Active Congestion Management (ACM).

The color of the packets is decided based on the conformance rate in the metering instance. See [Section 3.14.5.4](#) for details. The thresholds are checked with accordance to the incoming packet color. For example, red thresholds apply to red-colored packets, yellow for yellow-colored packets, and green for green-colored packets.

The switch macro is able to reserve a buffer per egress queue. This allows the protection of queues against congestion caused by other queues and ports. It provides a minimum buffer guarantee for each queue. A green frame is permitted to bypass ACM and is always accepted by the queue when the reserved buffer threshold of the queue is not exceeded.

Critical frames bypass the ACM and are enqueued regardless of the filling level. Critical frames are not enqueued only in case of a buffer full event or a packet pointer full event.

The ACM function discards the frames early, before the buffer full event, with a certain drop probability. ACM thresholds provide three functionalities:

- **Minimum (MIN) Threshold**
When the filling level of the queue is below this threshold, excluding the threshold value, the packet with the appropriate color is not discarded and is enqueued.
- **Maximum (MAX) Threshold**
When the filling level of the queue is above this threshold, excluding the threshold value, the packet with the appropriate color is discarded.
- **$\frac{1}{2}(\text{Maximum-Minimum})$ $\frac{1}{2}(\text{MAX-MIN})$ Threshold**
When the filling level of the queue is between the MIN and MAX thresholds, the packet is discarded with certain probability. The drop probability profile is selectable globally between 25%, 50% and 75%. When the filling level is below half the distance between the minimum and maximum thresholds, the packet is discarded with a lower probability (P_{\min}), when the filling level is above half the distance between the minimum and maximum thresholds, the packet is discarded with a higher probability (P_{\max}).

3.14.5.8 Egress Queue Congestion Notification

802.1Qau operates in the link layer to provide a means for a bridge to notify a source of congestion allowing the source to reduce the flow rate.

In switch macro, the congestion level of each egress queue is monitored. If the congestion level is greater than $\frac{1}{4}$ of green maximum threshold, congestion status of the egress queue is set to 1. If the congestion level is lower than $\frac{1}{4}$ of green minimum threshold, congestion status of the egress queue is cleared to 0.

3.14.5.9 Storm Control

The switch macro supports a broadcast storm control function. A broadcast storm is defined as an excessive amount of broadcast, multicast, or unknown unicast Ethernet frames received on a switch port. Due to the massive replication of data frames, broadcast storms significantly degrade the system performance. Intentional broadcast storms are a form of Denial-of-Service (DoS) attack.

The storm control function effectively polices specific traffic type and protect the resources from being flooded by broadcast traffic.

The selected metering instance is configured to the required policed rate of the broadcast storm. Several traffic types are selectable for the storm control function:

- Broadcast frames

- Unknown multicast frames
- Unknown unicast frames

When the rate of the selected frame types exceeds the rate configured in the meter instance, the frames are marked as either yellow or red. When the active congestion management thresholds are configured appropriately, the storm frames are discarded.

3.14.6 Flow Classification Function

The switch macro includes a powerful packet classification engine which performs multi-field classifications based on up to 512 programmable rules.

Traffic Flow Table

The traffic flow table contains up to 512 programmable rules. Rules are configurable per ingress port, but are also sharable between ports. Each rule consists of a pattern section and an action section. A pattern specifies certain combination of packet header fields. The parser extracts the packet header fields from the received packet and provides them to the traffic flow table. When a pattern matches, the enabled actions apply. The pattern search continues until all actions are satisfied. This allows the definition of multiple pattern for different actions. It is possible to enable or disable an action for a given pattern.

The location of a rule in the table defines its priority. A rule with a lower index number has higher priority. The traffic flow table is searched using pattern matching and action matching.

- **Pattern Match:**

A pattern row is considered matched when all of the fields in the pattern have been matched, not matched, or configured to be ignored. When a pattern row matches, the appropriate action row is checked for that pattern.
Note: It is possible for multiple pattern rows in a table to match the search, but only the first pattern in the table matched for certain action is applied.

The supported patterns include the source port information, packet length, and multiple L2/L3/L4/L4+ packet fields.

- **Action Match:**

Each action in the action row can be enabled or disabled for certain pattern row match. When the action is enabled and the pattern row matched, this action is applied for the classified packet. The search in the table terminates only when all the actions in the action section have been found. When not, the search continues for the next pattern match and the corresponding action match. An additional option is to enable the action and to select a default behavior for that action, in other words, the search for another enabled action is terminated.
Note: For a given packet classification only one pattern may match one specific action, however, multiple patterns may match multiple different actions, in other words, the action section is searched independently for each action type.

The supported actions include destination port(s) assignment (including discard option), port filtering, traffic class assignment, traffic meter assignment, extended VLAN tagging operation assignment, flow counter assignment, OAM handling assignment, cross VLAN policy, cross state policy, color assignment, Link Aggregation Group (LAG) assignment, L2 MAC address learning policy, and interrupt policy.

3.14.7 Operation, Administration, and Management Functions

This section summarizes the functions provided to control and monitor the data traffic through the switch.

3.14.7.1 Monitoring Counters

Multiple counters are provided per port to monitor incoming and outgoing data traffic as well as errors or special events. Each port provides the same set of counters. The groups of counters are:

- A set of standard Ethernet counters, also known as RMON counters in RFC2819.
- A group of counters assigned to programmable traffic flows.
- A group of counters for metering.
- A group of counters for MAC learning discard events.

3.14.7.2 Port Mirroring

The switch macro supports port monitoring and port redirection to assist in system debugging or to enable a software-controlled functionality. The data received on a selected port may be mirrored or redirected to another selected port (the monitoring port).

Mirroring Function

Ingress mirroring means the received frame is processed and forwarded as normal, but a copy of that frame is in addition sent to the monitoring port.

Egress mirroring means that the transmitted frame is forwarded as normal, but a copy of that egress frame (with modification) is in addition sent to the monitoring port.

The options given by the port mirroring function are:

- Copy data received on a selected port to the monitoring port.
- Copy data received on a selected group of ports to the monitoring port.
- Copy data transmitted on a selected port to the monitoring port.
- Copy data transmitted on a selected group of ports to the monitoring port.
- Copy data received or transmitted on a selected port to the monitoring port.
- Copy data received or transmitted on a selected group of ports to the monitoring port.

Figure 20 and **Figure 21** provide illustrations on the ingress and egress monitoring.

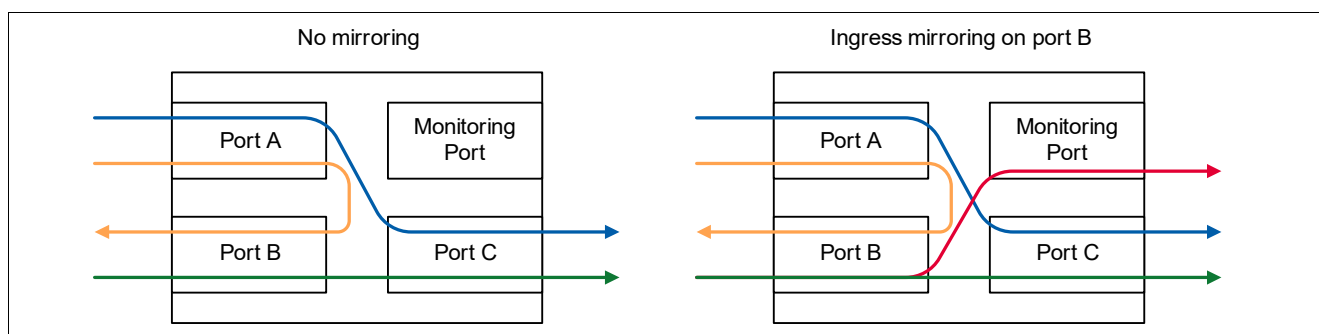

Figure 20 Port Mirroring Examples – Ingress Monitoring

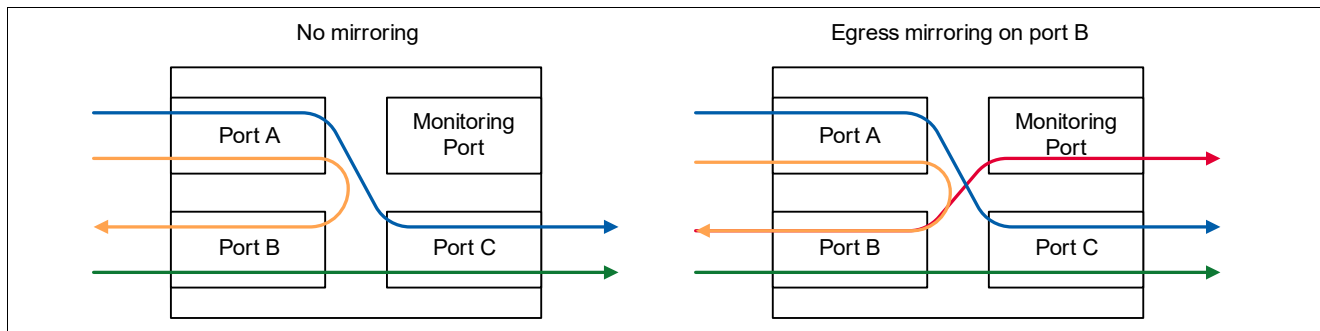

Figure 21 Port Mirroring Examples – Egress Monitoring

Mirroring is also usable to create diagnostic loopbacks, when the ingress port is identical to the monitoring port.

Error Monitoring

The mirroring function is used to monitor frames otherwise dropped due to reception errors, packet filtering, or violation of certain classification rules. In this case, the received frame is only delivered to the monitoring port and not to the target egress port defined in the egress port map.

It is possible to explicitly enable error monitoring for frames which contain MAC errors or when the MTU has been exceeded.

Egress Redirection Function

Egress redirection means that the received frame is processed but not forwarded as normal. Instead, that frame is sent to another MAC. **Figure 22** provides an illustration. The figure shows an egress traffic port B, which is the destination port, redirected to port D, the redirection port. Egress traffic is counted in port B's transmit counters. Egress packets are treated according to the configuration for port B.

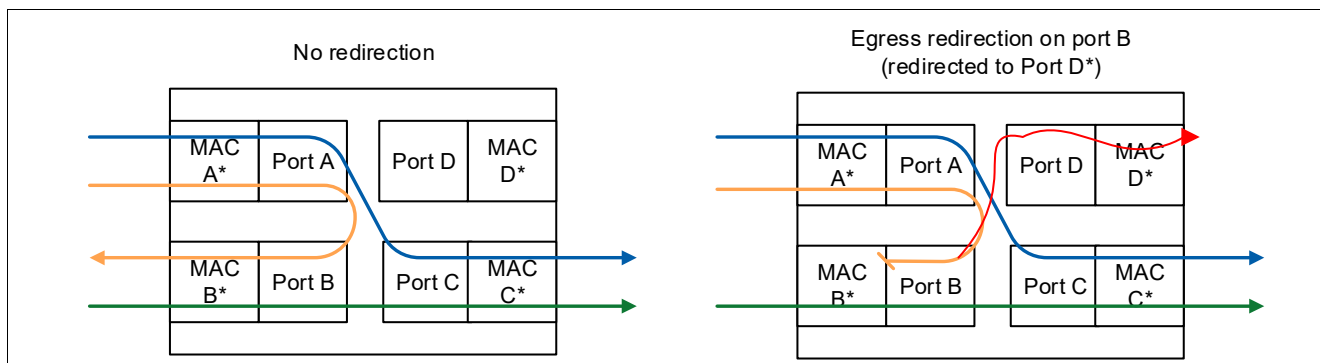

Figure 22 Port Redirection Examples – Egress Redirection

3.14.7.3 Special Tag Functionality

The special tag is used to override the forwarding and QoS functionality of the switch on the ingress side and to provide additional frame-status information on the egress side.

The special tag is identified by the special Ethertype field located after the source MAC address in the Ethernet frame. This allows the transmission of the frame via an Ethernet network to a remote receiver. The special tag content has a fixed length of 6 bytes. For internal communication or point-to-point communication it can be configured per egress port when the frame contains additional content in place of the Ethertype. This option is only available at egress direction, in ingress direction always an Ethertype is expected. See **Figure 23**.

The pause frames generated by the MAC do not contain a special tag. This may result in a mix of frames with and without a special tag on one egress port. Frames with a special tag which do not use the special Ethertype are

distinguishable from pause frames because pause frames have an Ethertype of 0x8808 while the first nibble after the MAC addresses is 0 for frames with a special tag.

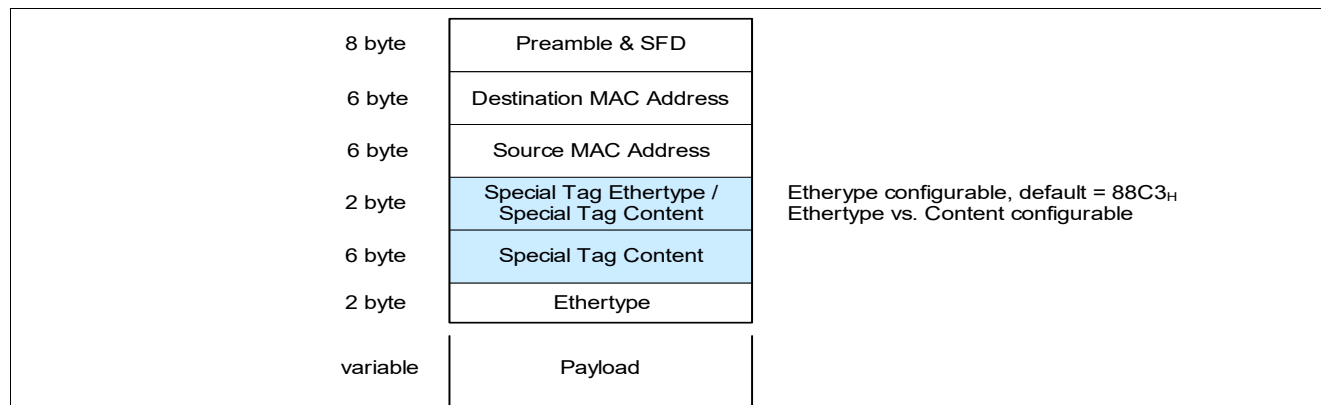

Figure 23 Special Tag Location in the Frame

Note: The special tag is used on the CPU port of the switch.

The content format of the special tag is different for the ingress and the egress.

Ingress Special Tag

The ingress special tag is used to override the classification function and the default frame forwarding of the switch. Special tag detection on ingress is enabled or disabled per port. When the detection is disabled, the frame containing a special tag is treated as regular frame and the content of the frame is ignored.

When the ingress special tag detection is enabled, the content of the tag is used for the frame forwarding decision. The ingress special tag must always have a special tag Ethertype. See [Table 26](#) for details.

Table 26 Special Tag Ingress Format

Byte	Bit	Description
0	[7:0]	Ethertype MSB Byte 1 Configurable. Default 88 _H .
1	[7:0]	Ethertype LSB Byte 2 Configurable. Default C3 _H .
2	[7]	Reserved Reserved. This field is not used internally by the switch.
2	[6:4]	Sub-interface ID [14:12] See the Sub-interface ID portions of this table for a description.
2	[3:0]	Traffic Class Target traffic class. This field is valid only when traffic class enable is set
3	[7]	Pre-L2: Bit 1 See below for description of Pre-L2 size.
3	[6]	OAM Flag (OAM) This is OAM packet (Delay measurement and loss measurement packet) 0 _B Disable Not OAM packet 1 _B Enable OAM packet

Table 26 Special Tag Ingress Format (cont'd)

Byte	Bit	Description
3	[5]	Forced Learning Disable (LNMD) Forced leaning disable control 0 _B Ignore Learning enable or disable is determined by the switch configurations 1 _B Disable Learning is forced to be disabled regardless of the switch configurations.
3	[4]	Traffic Class Enable (TC_EN) Traffic class enable 0 _B Ignore traffic class is determined by the switch configurations. 1 _B Enable traffic class is determined in special tag traffic class field.
3	[3]	Insertion Flag (INS) This is special packet (For example, Ethernet OAM or IGMP packets) and is inserted by CPU to the data path 0 _B Disable Not insertion packet 1 _B Enable Insertion packet.
3	[2]	Extraction Flag (EXT) This is special packet (For example, Ethernet OAM or IGMP packets) and is extracted to CPU from the data path 0 _B Disable Not extracted packet 1 _B Enable Extracted packet.
3	[1:0]	Packet Type (PKT_TYPE) 00 _B Ether Ethernet packet 10 _B 802.11 802.11 format X1 _B Reserved Reserved.
4	[7]	Pre-L2: Bit 0 Pre-L2 size in special tag does not include PMAC header and special tag. Pre-L2 size in packet descriptor includes PMAC header. 00 _B NIL No Pre-L2 header 01 _B 16B 16B Pre-L2 header 10 _B 32B 32B Pre-L2 header 11 _B 48 48B Pre-L2 header
4	[6]	Reserved
4	[5]	Reserved
4	[4]	Sub-interface ID [15] See below for description of sub-interface ID.
4	[3:0]	Sub-interface ID [11:8] See below for description of sub-interface ID.
5	[7:0]	Sub-Interface ID [7:0] For ingress special tag For packet with “Egress= 0” & “INS=1”, it carries source sub-interface ID. For packet with “Egress = 0” & “INS=0”, it carries source sub-interface ID. For packet with “Egress = 1” & “EXT=0”, it carries destination sub-interface ID. For packet with “Egress = 1” & “EXT=1”, it carries source sub-interface ID. For egress special tag: For “EXT=0”, it carries destination sub-interface ID. For “EXT=1”, it carries source sub-interface ID.
6	[7:0]	Record ID [11:4] It is used for logging information for PTP and OAM packets

Table 26 Special Tag Ingress Format (cont'd)

Byte	Bit	Description
7	[7:4]	Record ID [3:0] It is used for logging information for PTP and OAM packets
7	[3:0]	Source or Destination Logical Port ID (IGP/EGP) For ingress special tag: For packet with “Egress= 0” & “INS=1”, it carries source LPID. For packet with “Egress = 0” & “INS=0”, it carries source LPID. For packet with “Egress = 1” & “EXT=0”, it carries destination LPID. For packet with “Egress = 1” & “EXT=1”, it carries source LPID. For egress special tag For “EXT=0”, it carries destination LPID. For “EXT=1”, it carries source LPID.

Note: Bytes are defined as MSB = bit 7 and LSB = bit 0.

Table 27 describes the encoding of the traffic class enable fields of the special tag content.

Table 27 Traffic Class Map Coding

Traffic Class Enable	Resulting Traffic Class
0	The traffic class is based on the classification result in switch.
1	The traffic class is taken from the special tag (classified traffic class ignored).

An additional *Force No Learning* action flag is available in the ingress special tag. This action disables the learning of the source MAC address of the received frame in the MAC bridging table

The special tag detected on the ingress side is not delivered to the egress side. The tag is removed prior to transmission.

Egress Special Tag

The egress special tag contains the status and debug information of the switch. Special tag transmission on egress is enabled or disabled per egress port. When egress special tag is disabled, no special tag is inserted in the egress frame. When egress special tag function is enabled, each egress frame transmitted on that port contains the special tag.

See **Table 28** for more details regarding the egress special tag format.

Note: Bytes are defined as MSB = bit 7 and LSB = bit 0.

Table 28 Special Tag Egress Format

Byte	Bit	Description
0	[7:0]	Ethertype Byte 1 Configurable. Default 88 _H
1	[7:0]	Ethertype Byte 2 Configurable. Default: C3 _H
2	[7]	Reserved Reserved. This field is not used internally by the switch.
2	[6:4]	Sub-interface ID [14:12] See below for description of sub-interface ID.

Table 28 Special Tag Egress Format

Byte	Bit	Description
2	[3:0]	Traffic Class Traffic class of the packet determined by the switch QoS classification.
3	[7]	Pre-L2: Bit 1 See below for description of Pre-L2 size.
3	[6]	OAM Flag (OAM) This is OAM packet (Delay measurement and loss measurement packet) 0 _B Disable Not OAM packet 1 _B Enable OAM packet
3	[5]	Reserved This field is fixed to 0.
3	[4]	Reserved This field is fixed to 0.
3	[3]	Insertion Flag (INS) This is special packet (For example, Ethernet OAM or IGMP packets) and is inserted by CPU to the data path. 0 _B Disable Not insertion packet 1 _B Enable Insertion packet
3	[2]	Extraction Flag (EXT) This is special packet (For example, Ethernet OAM or IGMP packets) and is extracted to CPU from the data path. 0 _B Disable Not extracted packet 1 _B Enable Extracted packet
3	[1:0]	Packet Type (PKT_TYPE) 00 _B Ether Ethernet packet 10 _B 802.11 802.11 format X1 _B Reserved Reserved.
4	[7]	OAM Flag (OAM) This is OAM packet (Delay measurement and loss measurement packet) 0 _B Disable Not special OAM packet 1 _B Enable Special OAM packet
4	[6]	Reserved
4	[5]	Reserved
4	[4]	Sub-interface ID [15] See below for description of sub-interface ID.
4	[3:0]	Sub-interface ID [11:8] See below for description of sub-interface ID.
5	[7:0]	Sub-Interface ID [7:0] For “EXT=0”, it carries destination sub-interface ID. For “EXT=1”, it carries source sub-interface ID.
6	[7:0]	Record ID MSB bit 11 to 4. It is used for logging information for PTP and OAM packets

Table 28 Special Tag Egress Format

Byte	Bit	Description
7	[7:4]	Record ID MSB bit 3 to 0. It is used for logging information for PTP and OAM packets
7	[3:0]	Source or Destination Logical Port ID (IGP/EGP) For “EXT=0”, it carries destination logical port ID. For “EXT=1”, it carries source logical port ID.

3.14.7.4 Loop Detection

The loop detection feature detects a loop in the network and triggers an alarm, which is usually indicated by an LED. It does not prevent the loop like STP, so a network administrator must be able to clearly see the alarm and resolve the loop by manual means. The violating ports are not disabled by means of any protocol.

4 MDIO and MMD Register Interface Description

This chapter describes the MDIO and MMD registers available to support the MxL86282S feature set. These registers are accessible by an external management entity (called STA in IEEE) to control, configure, or read the status of the MxL86282S. After power-on, the MxL86282S resets the MDIO and MMD registers to default values sufficient to operate without specific programming.

All the register definitions, behaviors, and fields are strictly compliant with IEEE 802.3. Refer to IEEE 802.3 [6] for more information about the registers. The only registers not referenced in IEEE 802.3 are two register groups that are vendor-specific: VSPEC1 and VSPEC2. These allow custom functions related to MxL86282S.

In the register descriptions, the section or table references refer to the IEEE 802.3 [6].

4.1 MDIO-specific Terminology

This list describes how the common IEEE 802.3 terms relate to MDIO and MMD register concepts discussed in this chapter.

- **STA:** Station Management. A host connected to the MDIO interface. STAs are generally Media Access Controllers (MACs). The STA drives the MDIO bus as a clock master and the MxL86282S is an MDIO slave.
- **Host:** Used as a synonym of STA in this document.
- **PHY:** Physical Layer. In the MxL86282S, this encompasses Analog Signal Processing, Digital Signal Processing, and Physical Coding Sublayer (PCS). The PHY contains several sublayers that are individually manageable entities known as MDIO manageable devices (MMDs).
- **MMD:** MDIO Manageable Device. The list of MMDs available in the MxL86282S is in [Section 4.3](#).
- **Device:** In the context of the MDIO/MMD registers, a device is a register bank grouped by logical sublayers of the PHY layer.
- **Clause:** Refers to a particular section of the IEEE 802.3 standard [6]. In particular, Clause 22 describes MDIO device 0 and Clause 45 describes the other MMDs.
- **MII:** Media Independent Interface. This encompasses the MDIO and the (G)MII as described in Clause 22. STD registers in device 0 are also called MII registers.

4.2 Register Naming and Numbering

The register numbering convention in this document is similar to that of IEEE 802.3.

The numbering syntax uses three numbers, a.b.c, as specified in IEEE 802.3, paragraph 45.1 [6], and the notation is generalized to Clause 22 registers in device 0 STD. The alphanumeric syntax also uses the same structure and uses the names of the MMD devices, registers, and register fields separated by underscores and dots.

4.2.1 Register Numbering

The syntax is as follows, with a, b, and c written as decimal numbers:

a.b.c = <DEVICE_NUMBER>.<REGISTER_NUMBER>.<FIELD_NUMBER>

When the last indicator (c) is omitted, the register numbering refers to the full register.

When a field is more than a single bit, the bit range is indicated using a colon (for example, 1:3 is the field of bits 1 to 3). In an MDIO register, the least significant bit is bit 0 and most significant bit is bit 15. All MDIO registers are 16-bit wide.

4.2.2 Register Naming

The syntax is as follows, with AA, BB, and CC written as alphanumeric strings:

AA_BB.CC = <DEVICE_NAME>.<REGISTER_NAME>.<FIELD_NAME>

When the last indicator (CC) is omitted, the register naming refers to the full register.

The fields named RES, RES1, and RES2 refer to reserved fields as per IEEE 802.3.

4.2.3 Examples

STD_STAT.ANOK is the name of the field 0.1.5, which indicates that auto-negotiation is complete.

ANEG_CTRL.ANEG_RESTART is the name of the field 7.0.9, which allows the STA to restart the Ethernet ANEG procedure.

ANEG_PHYID1 is the complete 16-bit register number 7.2, for the PHY identifier 1 number.

VSPEC1_LED1.BLINKS is the 4-bit wide field number 30.2.15:12, which contains LED1 slow blinking configuration.

4.3 MMD Devices Present in MxL86282S

The MMD devices implement groups of standardized registers under the management of the STA.

Table 29 MDIO/MMD Devices Present in MxL86282S

MDIO/MMD Name	Device Number (decimal)	Description
STD	0	MDIO Standard Device as described in Clause 22. This also contains a number of MxL86282S-specific PHY registers.
PMA/PMD	1	Control and status registers related to the PMA/PMD signal processing modules
PCS	3	Control and status registers related to the PCS encoding/decoding device
ANEG	7	Control and status registers related to the auto-negotiation device
VSPEC1	30	MxL86282S-specific LED control and other MxL86282S-specific control
VSPEC2	31	MxL86282S-specific WoL control

4.4 Responsibilities of the STA

The MxL86282S responds to all published register addresses for the device and returns a value of zero for undefined and unsupported registers.

In accordance with IEEE 802.3 guidelines, it is the responsibility of the STA entity to ensure that mutually acceptable speeds are applied consistently across all the MMDs of the MxL86282S.

The MxL86282S ignores writes to the PMA/PMD speed selection bits that select speeds not advertised in the PMA/PMD speed ability register. The PMA/PMD speed selection defaults to a supported ability.

API is provided to access the PHY MDIO and MMD registers, which cannot be accessed directly.

4.5 MDIO Access Protocols to Read / Write Registers

All the MDIO/MMD registers are accessible from an external chip connected to the MDIO bus on the MDIO_S and MDC_S pins. The MxL86282S supports several MDIO frame protocols:

- Clause 22: To access Device 0
- Clause 22 Extended: To access other devices using the indirection scheme specified by IEEE 802.3
 - Dev 1: PMAPMD
 - Dev 3: PCS
 - Dev 7: ANEG
 - Dev 30: VSPEC1
 - Dev 31: VSPEC2
- Clause 45: to access all devices

Both Clause 22 Extended and Clause 45 are used to access MMD devices. However, the mechanism implemented in the MxL86282S provides faster speeds using Clause 45. It creates differences in latencies in the MDIO reply:

- The Clause 22 Extended protocol involves an indirect mechanism.
- The Clause 45 protocol provides faster replies.

The Clause 22 registers are accessed using the Clause 45 electrical interface and the Clause 22 management frame structure. Refer to IEEE 802.3 section 45 [\[6\]](#).

5 PHY MDIO Registers Detailed Description

Table 30 Register Access Type

Mode	Symbol
Read-Only Register (Status or Ability Register)	RO
Read-Write Register (MDIO Register)	RW
Read-Write Self-Clearing Register (bit cleared after read from MDIO)	RWSC
Read-Only Self-Clearing Register (bit cleared after read from MDIO)	ROSC
Read-Only Latching Low Register	ROLL
Read-Only Latching High Register	ROLH

5.1 Standard Management Registers

This section describes the IEEE 802.3 standard management registers corresponding to Clause 22.

Table 31 Registers Overview- Standard Management Registers

Register Short Name	Register Long Name	Reset Value
STD_CTRL	STD Control (Register 0.0)	3040 _H
STD_STAT	Status Register (Register 0.1)	7949 _H
STD_PHYID1	PHY Identifier 1 (Register 0.2)	C133 _H
STD_PHYID2	PHY Identifier 2 (Register 0.3)	5400 _H ¹⁾
STD_AN_ADV	Auto-Negotiation Advertisement (Register 0.4)	9DE1 _H
STD_AN_LPA	Auto-Negotiation Link Partner Ability (Register 0.5)	1DE0 _H
STD_AN_EXP	Auto-Negotiation Expansion (Register 0.6)	0064 _H
STD_AN_NPTX	Auto-Negotiation Next Page Transmit Register (Register 0.7)	2001 _H
STD_AN_NPRX	Auto-Negotiation Link Partner Received Next Page Register (Register 0.8)	0000 _H
STD_GCTRL	Gigabit Control Register (Register 0.9)	0200 _H
STD_GSTAT	Gigabit Status Register (Register 0.10)	0000 _H
STD_MMDCTRL	MMD Access Control Register (Register 0.13)	0000 _H
STD_MMDDATA	MMD Access Data Register (Register 0.14)	0000 _H
STD_XSTAT	Extended Status Register (Register 0.15)	2000 _H

1) For the device specific reset value, see the Product and Package Naming table in the [Product Ordering Information](#) chapter.

5.1.1 Standard Management Register Descriptions

This section describes all the STD registers in detail.

STD Control (Register 0.0)

This register controls the main functions of the PHY.

IEEE Standard Register=0.0

STD_CTRL

STD Control (Register 0.0)

Reset Value

3040_H

15	14	13	12	11	10	9	8	7	6	5	4	3	2	1	0
RST	LB	SSL	ANEN	PD	ISOL	ANRS	DPLX	COL	SSM						RES
RWSC	RW	RW	RW	RW	RW	RWSC	RW	RW	RW						RO

Field	Bits	Type	Description
RST	15	RWSC	<p>Reset Resets the PHY to its default state. Active links are terminated. This is a self-clearing bit, which is set to zero by the hardware after a reset is performed.</p> <p>0_B NORMAL Normal operational mode 1_B RESET Resets the device.</p>
LB	14	RW	<p>Loopback on GMII This mode enables looping back of MII data from the transmit to the receive direction. No data is transmitted to the Ethernet PHY. The device operates at the selected speed. The collision signal remains de-asserted unless otherwise forced by the collision test.</p> <p>0_B NORMAL Normal operational mode 1_B ENABLE Closes the loopback from Tx to Rx at xMII.</p>
SSL	13	RW	<p>Forced Speed Selection LSB This bit only takes effect when bit ANEN is set to zero, which disables the auto-negotiation process. This is the lower bit (LSB) of the forced speed selection and is used in conjunction with the higher bit (MSB). The standard procedure to force 2500 Mbps operation (when ANEG is disabled) is to program PMA_CTRL with 1.0.6 = 1.0.13 = 1 and 1.0.5:2 = [0 1 1 0]. The GPHY mirrors 1.0.6, 1.0.13 and 0.0.6, 0.0.13. This is the MSB LSB bit value encoding:</p> <p>00_B 10 Mbps 01_B 100 Mbps 10_B 1000 Mbps 11_B Reserved, defaults to 2500 Mbps operation when the PMA_CTRL register 1.0.5:2 equals [0 1 1 0].</p>

Field	Bits	Type	Description (cont'd)
ANEN	12	RW	Auto-Negotiation Enable Allows enabling and disabling of the auto-negotiation process capability of the PHY. When enabled, the force bits for duplex mode (CTRL.DPLX) and the speed selection (CTRL.SSM, CTRL.SSL) become inactive; otherwise, the force bits define the PHY operation. 0 _B DISABLE Disables the auto-negotiation protocol. 1 _B ENABLE Enables the auto-negotiation protocol.
PD	11	RW	Power Down Forces the device into a power down state (SLEEP) in which power consumption is the bare minimum required to still maintain the MII management interface communication. When activating the power down functionality, the PHY terminates active data links. The MII interface is also stopped in power down mode. 0 _B NORMAL Normal operational mode 1 _B POWERDOWN Forces the device into power down mode.
ISOL	10	RW	Isolate The isolation mode isolates the PHY from the MAC. The MAC interface inputs are ignored, whereas the MAC interface outputs are set to tristate (high-impedance). 0 _B NORMAL Normal operational mode 1 _B ISOLATE Isolates the PHY from the MAC.
ANRS	9	RWSC	Restart Auto-Negotiation Restarts the auto-negotiation process on the MDI. This bit does not have any effect when auto-negotiation is disabled using CTRL.ANEN. This bit is self-clearing after the auto-negotiation process is initiated. 0 _B NORMAL Stays in current mode. 1 _B RESTART Restarts auto-negotiation.
DPLX	8	RW	Forced Duplex Mode This bit only takes effect when bit CTRL.ANEN is set to zero, which disables the auto-negotiation process. This bit controls the forced duplex mode. It allows forcing of the PHY into full-duplex or half-duplex mode. This bit does not take effect in loopback mode, when bit CTRL.LB is set to 1 _B . It is only possible to force the duplex mode to half-duplex in 10BASE-T and 100BASE-TX speed modes. This field is ignored for higher speeds. 0 _B HD Half-duplex 1 _B FD Full-duplex
COL	7	RW	Collision Test Allows testing of the COL signal at the xMII interface. When the collision test is enabled, the state of the TX_EN signal is looped back to the COL signal within a minimum latency. 0 _B DISABLE Normal operational mode 1 _B ENABLE Activates the collision test.

Field	Bits	Type	Description (cont'd)
SSM	6	RW	<p>Forced Speed Selection MSB</p> <p>This bit only takes effect when bit ANEN is set to zero, which disables the auto-negotiation process. This is the higher bit (MSB) of the forced speed selection and is used in conjunction with the lower bit (LSB).</p> <p>The preferred way to force 2500 Mbps operation (when ANEG is disabled) is to program PMA_CTRL with 1.0.6 = 1.0.13 = 1 and 1.0.5:2 = [0 1 1 0].</p> <p>The GPHY mirrors 1.0.6, 1.0.13 and 0.0.6, 0.0.13.</p> <p>This is the MSB LSB bit value encoding:</p> <p>00_B 10 Mbps 01_B 100 Mbps 10_B 1000 Mbps 11_B Reserved, defaults to 2500 Mbps operation when the PMA_CTRL register 1.0.5:2 equals [0 1 1 0].</p>
RES	5:0	RO	<p>Reserved</p> <p>Write as zero, ignore on read.</p>

Status Register (Register 0.1)

This register contains status and capability information about the device. All the bits are read-only. A write access by the MAC does not have any effect. Refer to IEEE 802.3 22.2.4.2.

IEEE Standard Register=0.1

STD_STAT

Reset Value

Status Register (Register 0.1)

7949_H

15	14	13	12	11	10	9	8	7	6	5	4	3	2	1	0	
CBT4	CBTX F	CBTX H	XBTF	XBTH	CBT2F	CBT2 H	EXT	RES	MFPS	ANOK	RF	ANAB	LS	JD	XCAP	
ro	ro	ro	ro	ro	ro	ro	ro	ro	ro	ro	ro	rolh	ro	roll	rolh	ro

Field	Bits	Type	Description
CBT4	15	RO	IEEE 100BASE-T4 Specifies the 100BASE-T4 ability. 0 _B DISABLED PHY does not support this mode. 1 _B ENABLED PHY supports this mode.
CBTXF	14	RO	IEEE 100BASE-TX Full Duplex Specifies the 100BASE-TX full duplex capability. 0 _B DISABLED PHY does not support this mode. 1 _B ENABLED PHY supports this mode.
CBTXH	13	RO	IEEE 100BASE-TX Half-Duplex Specifies the 100BASE-TX half-duplex capability. 0 _B DISABLED PHY does not support this mode. 1 _B ENABLED PHY supports this mode.
XBTF	12	RO	IEEE 10BASE-T Full-Duplex Specifies the 10BASE-T full-duplex capability. 0 _B DISABLED PHY does not support this mode. 1 _B ENABLED PHY supports this mode.
XBTH	11	RO	IEEE 10BASE-T Half-Duplex Specifies the 10BASE-T half-duplex capability. 0 _B DISABLED PHY does not support this mode. 1 _B ENABLED PHY supports this mode.
CBT2F	10	RO	IEEE 100BASE-T2 Full-Duplex Specifies the 100BASE-T2 full-duplex capability. 0 _B DISABLED PHY does not support this mode. 1 _B ENABLED PHY supports this mode.
CBT2H	9	RO	IEEE 100BASE-T2 Half-Duplex Specifies the 100BASE-T2 half-duplex capability. 0 _B DISABLED PHY does not support this mode. 1 _B ENABLED PHY supports this mode.

Field	Bits	Type	Description (cont'd)
EXT	8	RO	Extended Status The extended status registers are used to specify 1000 Mbps speed capabilities in the register XSTAT. 0 _B DISABLED No extended status information available in register 15 1 _B ENABLED Extended status information available in register 15
RES	7	RO	Reserved Ignore when read.
MFPS	6	RO	Management Preamble Suppression Specifies the Management Frame (MF) preamble suppression ability. 0 _B DISABLED PHY requires management frames with preamble. 1 _B ENABLED PHY accepts management frames without preamble.
ANOK	5	RO	Auto-Negotiation Completed Indicates whether the auto-negotiation process is completed or in progress. 0 _B RUNNING Auto-negotiation process is in progress. 1 _B COMPLETED Auto-negotiation process is completed.
RF	4	ROLH	Remote Fault Indicates the detection of a remote fault event. GPHY does not indicate RF. 0 _B INACTIVE No remote fault condition detected 1 _B ACTIVE Remote fault condition detected
ANAB	3	RO	Auto-Negotiation Ability Specifies the auto-negotiation ability. 0 _B DISABLED PHY is not able to perform auto-negotiation. 1 _B ENABLED PHY is able to perform auto-negotiation.
LS	2	ROLL	Link Status Indicates the link status of the PHY to the link partner. 0 _B INACTIVE The link is down. No communication with link partner possible. 1 _B ACTIVE The link is up. Data communication with link partner is possible.
JD	1	ROLH	Jabber Detect Indicates that a jabber event was detected. 0 _B NONE No jabber condition detected 1 _B DETECTED Jabber condition detected
XCAP	0	RO	Extended Capability Indicates the availability and support of extended capability registers. 0 _B DISABLED Only base registers are supported. 1 _B ENABLED Extended capability registers are supported.

PHY Identifier 1 (Register 0.2)

This code specifies the Organizationally Unique Identifier (OUI), and the vendor's model and revision number.
IEEE Standard Register=0.2

STD_PHYID1 **Reset Value**
PHY Identifier 1 (Register 0.2) **C133_H**

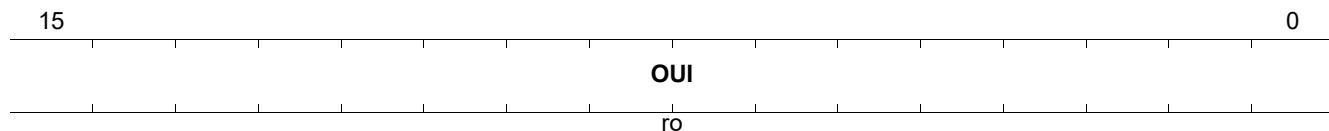

Field	Bits	Type	Description
OUI	15:0	RO	Organizationally Unique Identifier Bits 3:18

PHY Identifier 2 (Register 0.3)

IEEE Standard Register=0.3

STD_PHYID2

PHY Identifier 2 (Register 0.3)

Reset Value

5400_H

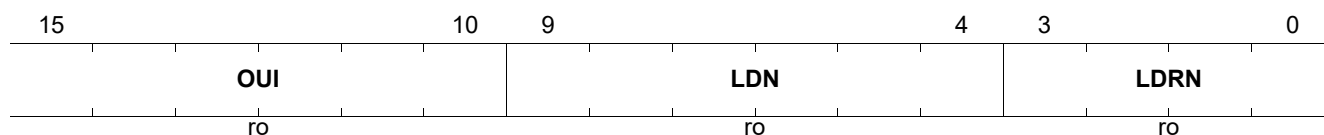

Field	Bits	Type	Description
OUI	15:10	RO	Organizationally Unique Identifier Bits 19:24
LDN	9:4	RO	Device Number Specifies the device number ¹⁾ to distinguish between several different products.
LDRN	3:0	RO	Device Revision Number Specifies the device revision number ¹⁾ to distinguish between several versions of this device.

1) For the device specific reset value, see the Product and Package Naming table in the [Product Ordering Information](#) chapter.

Auto-Negotiation Advertisement (Register 0.4)

This register contains the advertised abilities of the PHY during auto-negotiation.

IEEE Standard Register=0.4

STD_AN_ADV
Reset Value
Auto-Negotiation Advertisement (Register 0.4)
9DE1_H

15	14	13	12	11			5	4		0
NP	RES	RF	XNP			TAF			SF	
rw	ro	rw	rw			rw			rw	

Field	Bits	Type	Description
NP	15	RW	Next Page The next page indication is encoded in bit AN_ADV.NP regardless of the selector field value or link code word encoding. The PHY always advertises NP when a 1000BASE-T mode is advertised during auto-negotiation. 0 _B INACTIVE No next page to follow 1 _B ACTIVE Additional next page(s) to follow
RES	14	RO	Reserved Write as zero, ignore on read.
RF	13	RW	Remote Fault This bit allows indication of a fault to the link partner. 0 _B NONE No remote fault is indicated. 1 _B FAULT A remote fault is indicated.
XNP	12	RW	Extended Next Page Indicates the GPHY supports transmission of extended next pages (XNP). 0 _B UNABLE GPHY is XNP unable. 1 _B ABLE GPHY is XNP able.
TAF	11:5	RW	Technology Ability Field This is an 8-bit wide field containing information indicating supported technologies. The GPHY supports half-duplex and full-duplex 10BASE-T and 100BASE-TX and also both symmetric and asymmetric PAUSE. 40 _H PS_ASYM Advertises asymmetric pause 20 _H PS_SYM Advertises symmetric pause 10 _H DBT4 Advertises 100BASE-T4 08 _H DBT_FDX Advertises 100BASE-TX full-duplex 04 _H DBT_HDX Advertises 100BASE-TX half-duplex 02 _H XBT_FDX Advertises 10BASE-T full-duplex 01 _H XBT_HDX Advertises 10BASE-T half-duplex

Field	Bits	Type	Description (cont'd)
SF	4:0	RW	<p>Selector Field</p> <p>This field is a 5-bit wide field for encoding 32 possible messages. The encodings are defined in IEEE 802.3-2008 Annex 28A. Unspecified combinations are reserved for future use. Reserved combinations of this field are not to be transmitted.</p> <p>00001_B IEEE802DOT3 Selects the IEEE 802.3 technology.</p>

Auto-Negotiation Link Partner Ability (Register 0.5)

IEEE Standard Register=0.5

When the auto-negotiation is complete, this register contains the advertised ability of the link partner. The bit definitions are a direct representation of the received link code word.

STD_AN_LPA
Reset Value
Auto-Negotiation Link Partner Ability (Register 0.5)
1DE0_H

15	14	13	12	11						5	4							0
NP	ACK	RF	XNP															SF
ro	ro	ro	rw															ro

Field	Bits	Type	Description
NP	15	RO	Next Page Next page request indication from the link partner. 0 _B INACTIVE No next page to follow 1 _B ACTIVE Additional next pages to follow
ACK	14	RO	Acknowledge Acknowledgment indication from the link partner's link code word. 0 _B INACTIVE The device did not receive its link partner's link code word. 1 _B ACTIVE The device received its link partner's link code word.
RF	13	RO	Remote Fault Remote fault indication from the link partner. 0 _B NONE Remote fault is not indicated by the link partner. 1 _B FAULT Remote fault is indicated by the link partner.
XNP	12	RW	Extended Next Page Indicates the GPHY supports transmission of extended next pages (XNP). 0 _B UNABLE Link partner is XNP unable. 1 _B ABLE Link partner is XNP able.
TAF	11:5	RW	Technology Ability Field 40 _H PS_ASYM Advertises asymmetric pause 20 _H PS_SYM Advertises symmetric pause 10 _H DBT4 Advertises 100BASE-T4 08 _H DBT_FDX Advertises 100BASE-TX full-duplex 04 _H DBT_HDX Advertises 100BASE-TX half-duplex 02 _H XBT_FDX Advertises 10BASE-T full-duplex 01 _H XBT_HDX Advertises 10BASE-T half-duplex
SF	4:0	RO	Selector Field 00001 _B IEEE802DOT3 Selects the IEEE 802.3 technology

Auto-Negotiation Expansion (Register 0.6)

This is the auto-negotiation expansion register indicating the status of the link partner's auto-negotiation. This register is valid only after the auto-negotiation is completed.

Refer to IEEE 802.3 28.2.4.1.5.

IEEE Standard Register=0.6

STD_AN_EXP

Auto-Negotiation Expansion (Register 0.6)

Reset Value

0064_H

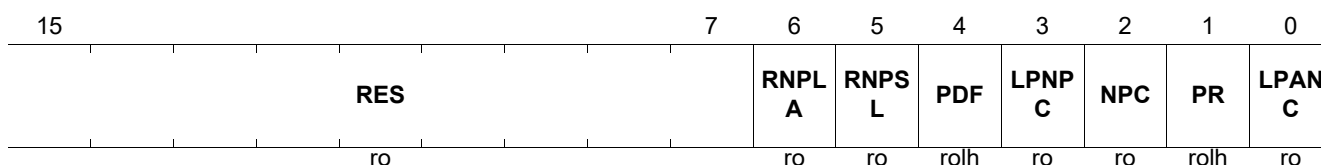

Field	Bits	Type	Description
RES	15:7	RO	Reserved Write as zero, ignore on read.
RNPLA	6	RO	Receive Next Page Location Able According to 802.3-2015, indicates the Rx NP location is indicated by field RNPSL. 0 _B UNABLE Received Next Page Storage Location is not specified by bit (6.5). 1 _B ABLE Received Next Page Storage Location is specified by bit (6.5).
RNPSL	5	RO	Receive Next Page Storage Location According to 802.3-2015, indicates the Rx NP is in register 0.8 for the GPHY. 0 _B FIVE Link partner next pages are stored in register 5. 1 _B EIGHT Link partner next pages are stored in register 8.
PDF	4	ROLH	Parallel Detection Fault 0 _B NONE A fault was not detected via the parallel detection function. 1 _B FAULT A fault was detected via the parallel detection function.
LPNPC	3	RO	Link Partner Next Page Capable 0 _B UNABLE Link partner is unable to exchange next pages. 1 _B CAPABLE Link partner is capable of exchanging next pages.
NPC	2	RO	Next Page Capable 0 _B UNABLE GPHY is unable to exchange next pages. 1 _B CAPABLE GPHY is capable of exchanging next pages.
PR	1	ROLH	Page Received 0 _B NONE A new page was not received. 1 _B RECEIVED A new page was received.
LPANPC	0	RO	Link Partner Auto-Negotiation Capable 0 _B UNABLE Link partner is unable to auto-negotiate. 1 _B CAPABLE Link partner is auto-negotiation capable.

Field	Bits	Type	Description (cont'd)
MCF	10:0	RW	<p>Message or Unformatted Code Field</p> <p>When the Message Page bit is set to 1_B (0.7.13), this field is the Message Code Field of a message page used in next page exchange. The message codes are described in IEEE 802.3 Appendix 28C. It is used to indicate the type of message in UCF1 and UCF2.</p> <p>00_H Reserved 01_H Null message 02_H One Unformatted Page (UP) with TAF follows 03_H Two UPs with TAF follows 04_H Remote fault details message 05_H OUI message 06_H PHY ID message 07_H 100BASE-T2 message 08_H 1000BASE-T message 09_H MULTIGBASE-T message 0A_H EEE technology capability follows in next UP 0B_H OUI XNP</p>

Auto-Negotiation Link Partner Received Next Page Register (Register 0.8)

This register contains the next page link code word received from the link partner. Refer to IEEE 802.3-2008 28.2.4.1.7.

IEEE Standard Register=0.8

STD_AN_NPRX

Reset Value

Auto-Negotiation Link Partner Received Next Page Register (Register 0.8)

0000_H

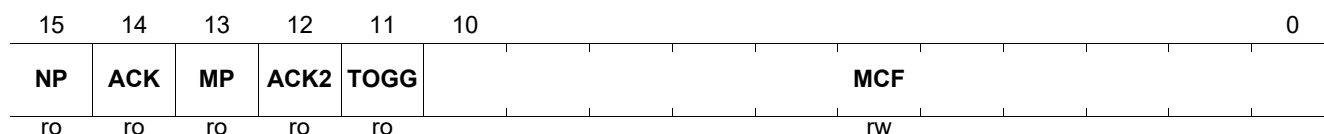

Field	Bits	Type	Description
NP	15	RO	Next Page 0 _B INACTIVE No next pages to follow 1 _B ACTIVE Additional next page(s) to follow
ACK	14	RO	Acknowledge 0 _B INACTIVE The device did not receive its link partner's link code word. 1 _B ACTIVE The device received its link partner's link code word.
MP	13	RO	Message Page Indicates the content of MCF is either an unformatted page or a formatted message. 0 _B UNFOR Unformatted page 1 _B MESSG Message page
ACK2	12	RO	Acknowledge 2 0 _B INACTIVE Device is not able to comply with the message. 1 _B ACTIVE Device complies with the message.
TOGG	11	RO	Toggle This bit always takes the opposite value of the Toggle bit in the previously exchanged link code word. 0 _B ZERO Previous value of the transmitted link code word was 1 _B . 1 _B ONE Previous value of the transmitted link code word was 0 _B .

Field	Bits	Type	Description (cont'd)
MCF	10:0	RW	<p>Message or Unformatted Code Field</p> <p>This field is the Message Code Field of a message page used in next page exchange.</p> <p>The message codes are described in IEEE 802.3 Appendix 28C. It is used to indicate the type of message in UCF1 and UCF2.</p> <p>00_H Reserved 01_H Null message 02_H One Unformatted Page (UP) with TAF follows 03_H Two UPs with TAF follows 04_H Remote fault details message 05_H OUI message 06_H PHY ID message 07_H 100BASE-T2 message 08_H 1000BASE-T message 09_H MULTIGBASE-T message 0A_H EEE technology capability follows in next UP 0B_H OUI XNP</p>

Gigabit Control Register (Register 0.9)

This is the control register to configure the Gigabit Ethernet behavior of the PHY. Refer to IEEE 802.3-2008 40.5.1.1.

IEEE Standard Register=0.9

STD_GCTRL

Reset Value

Gigabit Control Register (Register 0.9)

0200_H

15	13	12	11	10	9	8	7				0
TM		MSEN	MS	MSPT	MBTF D	MBTH D	RES				
rw		rw	rw	rw	rw	rw	ro				

Field	Bits	Type	Description
TM	15:13	RW	Transmitter Test Mode This register field allows enabling of the standard transmitter test modes. 000 _B NOP Normal operation 001 _B WAV Test mode 1 transmit waveform test 010 _B JITM Test mode 2 transmit jitter test in master mode 011 _B JITS Test mode 3 transmit jitter test in slave mode 100 _B DIST Test mode 4 transmitter distortion test
MSEN	12	RW	Master/Slave Manual Configuration Enable 0 _B DISABLED Disables master/slave manual configuration value. 1 _B ENABLED Enables master/slave manual configuration value.
MS	11	RW	Master/Slave Configuration Value Allows forcing of master or slave mode manually when AN_GCTRL.MSEN is set to 1 _B . 0 _B SLAVE Configures PHY as slave during master/slave negotiation. 1 _B MASTER Configures PHY as master during master/slave negotiation.
MSPT	10	RW	Master/Slave Port Type Defines whether the PHY advertises itself as a multi- or single-port device, which in turn impacts the master/slave resolution function. 0 _B SPD Single-port device 1 _B MPD Multi-port device
MBTFD	9	RW	1000BASE-T Full-Duplex Advertises the 1000BASE-T full-duplex capability; always forced to 1 in converter mode. 0 _B DISABLED Advertises PHY as not 1000BASE-T full-duplex capable 1 _B ENABLED Advertises PHY as 1000BASE-T full-duplex capable

Field	Bits	Type	Description (cont'd)
MBTHD	8	RW	<p>1000BASE-T Half-Duplex Always advertises the 1000BASE-T half-duplex capability as disabled. The GPHY does not support 1000BASE-T half-duplex capability.</p> <p>0_B DISABLED Advertises PHY as not 1000BASE-T half-duplex capable</p> <p>1_B ENABLED Advertises PHY as 1000BASE-T half-duplex capable</p>
RES	7:0	RO	<p>Reserved Write as zero, ignore on read.</p>

Gigabit Status Register (Register 0.10)

This is the status register used to reflect the Gigabit Ethernet status of the PHY. Refer to IEEE 802.3-2022 40.5.1.1.

IEEE Standard Register=0.10

STD_GSTAT

Reset Value

Gigabit Status Register (Register 0.10)

0000_H

15	14	13	12	11	10	9	8	7											0
MSFA ULT	MSRE S	LRXS TAT	RRXS TAT	MBTF D	MBTH D	RES			IEC										
rwsc	ro	ro	ro	ro	ro	ro			rwsc										

Field	Bits	Type	Description
MSFAULT	15	RWSC	Master/Slave Manual Configuration Fault This bit is set when the number of failed master-slave resolutions reaches 7. It is cleared upon each read of GSTAT. This bit self clears on auto-negotiation enable or auto-negotiation complete. 0 _B OK Master/slave manual configuration resolved successfully 1 _B NOK Master/slave manual configuration resolved with a fault
MSRES	14	RO	Master/Slave Configuration Resolution 0 _B SLAVE Local PHY configuration resolved to SLAVE 1 _B MASTER Local PHY configuration resolved to MASTER
LRXSTAT	13	RO	Local Receiver Status Indicates the status of the local receiver. 0 _B NOK Local receiver not OK 1 _B OK Local receiver OK
RRXSTAT	12	RO	Remote Receiver Status Indicates the status of the remote receiver. 0 _B NOK Remote receiver not OK 1 _B OK Remote receiver OK
MBTFD	11	RO	Link Partner Capable of Operating 1000BASE-T Full-Duplex 0 _B DISABLED Link partner is not capable of operating 1000BASE-T full-duplex 1 _B ENABLED Link partner is capable of operating 1000BASE-T full-duplex
MBTHD	10	RO	Link Partner Capable of Operating 1000BASE-T Half-Duplex 0 _B DISABLED Link partner is not capable of operating 1000BASE-T half-duplex 1 _B ENABLED Link partner is capable of operating 1000BASE-T half-duplex
RES	9:8	RO	Reserved Write as zero, ignore on read.

Field	Bits	Type	Description (cont'd)
IEC	7:0	RWSC	Idle Error Count Indicates the idle error count. This field contains a cumulative count of the errors detected when the receiver receives idles.

MMD Access Control Register (Register 0.13)

The MMD access control register is used in conjunction with the MMDDATA register to access the MMD register space. This uses address directing as specified in IEEE 802.3 Clause 22 Extended.

IEEE Standard Register=0.13

STD_MMDCTRL

Reset Value

MMD Access Control Register (Register 0.13)

0000_H

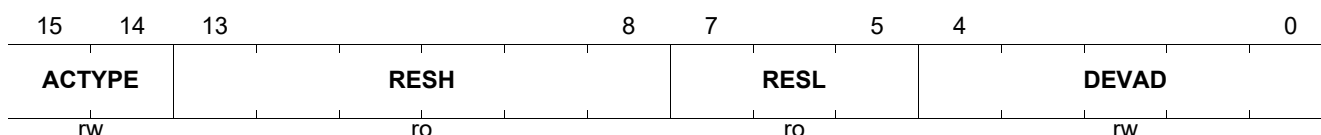

Field	Bits	Type	Description
ACTYPE	15:14	RW	Access Type Function When the MMDDATA register is accessed via an address access (ACTYPE=0), the access is directed to the address register within the MMD associated with the value in the DEVAD field. Otherwise, both the DEVAD field and the MMD address register direct the MMDDATA register data accesses to the appropriate registers within that MMD. 00 _B ADDRESS Accesses to the MMDDATA register access the MMD individual address register. 01 _B DATA Accesses to the MMDDATA register access the register within the MMD selected. 10 _B DATA_PI Accesses to the MMDDATA register access the register within the MMD selected. 11 _B DATA_PIWR Accesses to the MMDDATA register access the register within the MMD selected.
RESH	13:8	RO	Reserved Write as zero, ignored on read.
RESL	7:5	RO	Reserved Write as zero, ignored on read.
DEVAD	4:0	RW	Device Address The DEVAD field directs any accesses of register MMDDATA to the appropriate MMD as described in IEEE 802.3-2008 Clause 45.2.

MMD Access Data Register (Register 0.14)

The MMD access data register is used in conjunction with the MMD access control (MMDCTRL) register to access the MMD register space. For more information on MMD access, refer to IEEE 802.3-2008 Clause 22.2.4.3.12, Clause 45.2, and Annex 22D.

IEEE Standard Register=0.14

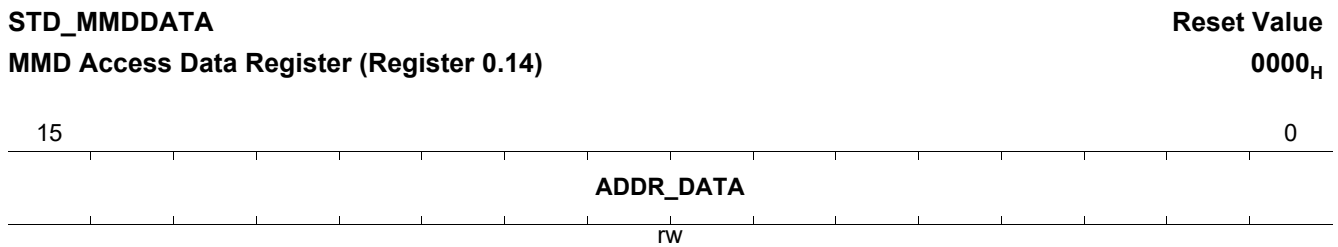

Field	Bits	Type	Description
ADDR_DATA	15:0	RW	Address or Data Register This register accesses either a specific MMD address register or the data content of the MMD register to which this address register points. The MMDCTRL register defines which function is currently valid.

Extended Status Register (Register 0.15)

This register contains extended status and capability information about the PHY. All the bits are read-only. A write access does not have any effect.

IEEE Standard Register=0.15

STD_XSTAT

Reset Value

Extended Status Register (Register 0.15)

2000_H

15	14	13	12	11	8	7	0
MBXF	MBXH	MBTF	MBTH		RESH		RESL
ro	ro	ro	ro		ro		ro

Field	Bits	Type	Description
MBXF	15	RO	1000BASE-X Full-Duplex Capability Specifies whether the PHY is capable of operating 1000BASE-X full-duplex. 0 _B DISABLED PHY does not support this mode. 1 _B ENABLED PHY supports this mode.
MBXH	14	RO	1000BASE-X Half-Duplex Capability Specifies whether the PHY is capable of operating 1000BASE-X half-duplex. 0 _B DISABLED PHY does not support this mode. 1 _B ENABLED PHY supports this mode.
MBTF	13	RO	1000BASE-T Full-Duplex Capability Specifies whether the PHY is capable of operating 1000BASE-T full-duplex. 0 _B DISABLED PHY does not support this mode. 1 _B ENABLED PHY supports this mode.
MBTH	12	RO	1000BASE-T Half-Duplex Capability GPHY do not support 1000BASE-T half-duplex capability. 0 _B DISABLED PHY does not support this mode. 1 _B ENABLED PHY supports this mode.
RESH	11:8	RO	Reserved Ignore when read.
RESL	7:0	RO	Reserved Ignore when read.

5.2 PHY-specific Management Registers

This section describes the PHY-specific management registers in device 0.

Table 32 Registers Overview- PHY-specific Management Registers

Register Short Name	Register Long Name	Reset Value
PHY_STAT1	Physical Layer Status 1 (Register 0.17)	000C _H
PHY_CTL1	Physical Layer Control 1 (Register 0.19)	0001 _H
PHY_CTL2	Physical Layer Control 2 (Register 0.20)	0006 _H
PHY_ERRCNT	Error Counter (Register 0.21)	0000 _H
PHY_MIISTAT	Media-Independent Interface Status (Register 0.24)	0000 _H
PHY_IMASK	Interrupt Mask Register (Register 0.25)	0000 _H
PHY_ISTAT	Interrupt Status Register (Register 0.26)	0000 _H
PHY_LED	LED Control Register (Register 0.27)	FF00 _H
PHY_TPGCTRL	Test-Packet Generator Control (Register 0.28)	0000 _H
PHY_TPGDATA	Test-Packet Generator Data (Register 0.29)	00AA _H
PHY_FWV	Firmware Version Register (Register 0.30)	0000 _H

5.2.1 PHY-specific Management Register Descriptions

This section describes all the PHY registers in detail.

Physical Layer Status 1 (Register 0.17)

This register reports PHY link information, for example link-up, polarity reversals, and port mapping. The content of this register is only valid when the link is up.

IEEE Standard Register=0.17

PHY_STAT1

Physical Layer Status 1 (Register 0.17)

Reset Value

000C_H

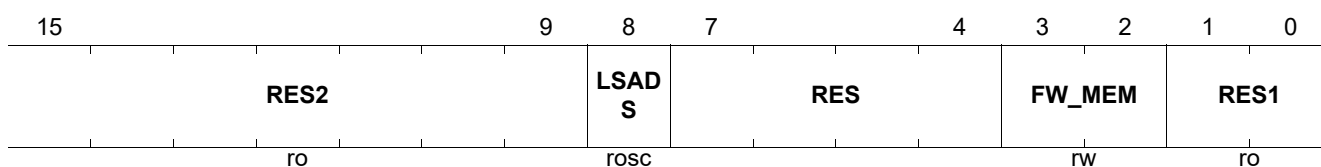

Field	Bits	Type	Description
RES2	15:9	RO	Reserved Write as zero, ignored on read.
LSADS	8	ROSC	Link Speed Auto-Downspeed Status Monitors the status of the Auto-Downspeed (ADS). 0 _B NORMAL Did not perform any link speed ADS. 1 _B DETECTED Detected an ADS.
FW_MEM	3:2	RW	Firmware Memory Location Indicates memory target used for firmware execution. 11 _B RAM Firmware is executed from SRAM. Others: Reserved.
RES1	1:0	RO	Reserved Write as zero, ignored on read.

Physical Layer Control 1 (Register 0.19)

This register controls the PHY functions.

IEEE Standard Register=0.19

PHY_CTL1

Physical Layer Control 1 (Register 0.19)

Reset Value

0001_H

15	13	12	11	8	7	6	5	4	3	2	1	0	
TLOOP		TXOFF	TXADJ			POLD	POLC	POLB	POLA	MDIC D	MDIA B	RES	AMDIX
rw		rw	rw			rw	rw	rw	rw	rw	rw	ro	rw

Field	Bits	Type	Description
TLOOP	15:13	RW	Test Loop Configures predefined test loops. 000 _B OFF Test loops are switched off - normal operation. 001 _B NETL Near-end test loop 010 _B FETL Far-end test loop. 100 _B RJTL RJ45 connector test loop. 101 _B FETL S Standalone far-end test loop. No dependency on GMII_TX_CLK and GMII_RX_CLK. Others: Reserved.
TXOFF	12	RW	Transmitter Off This register bit turns the transmitter off. This feature is used for return loss measurements. 0 _B ON Transmitter is on. 1 _B OFF Transmitter is off.
TXADJ	11:8	RW	Transmit Level Adjustment Reserved.
POLD	7	RW	Polarity Inversion Control on Port D 0 _B NORMAL Polarity normal 1 _B INVERTED Polarity inversion
POLC	6	RW	Polarity Inversion Control on Port C 0 _B NORMAL Polarity normal 1 _B INVERTED Polarity inversion
POLB	5	RW	Polarity Inversion Control on Port B 0 _B NORMAL Polarity normal 1 _B INVERTED Polarity inversion
POLA	4	RW	Polarity Inversion Control on Port A 0 _B NORMAL Polarity normal 1 _B INVERTED Polarity inversion
MDICD	3	RW	Mapping of MDI Ports C and D Used when Auto-MDIX is OFF to force the MDIX cable crossover configuration. 0 _B MDI Normal MDI mode 1 _B MDIX Crossover MDI-X mode

Field	Bits	Type	Description (cont'd)
MDIAB	2	RW	Mapping of MDI Ports A and B Used when Auto-MDIX is OFF to force the MDIX cable crossover configuration. 0 _B MDI Normal MDI mode 1 _B MDIX Crossover MDI-X mode
RES	1	RO	Reserved
AMDIX	0	RW	PHY Performs Auto-MDI/MDI-X or Uses Manual MDI/MDI-X 0 _B MANUAL PHY uses manual MDI/MDI-X. 1 _B AUTO PHY performs Auto-MDI/MDI-X.

Field	Bits	Type	Description (cont'd)
ANPD	1	RW	<p>Auto-Negotiation Power Down Allows enabling/disabling of the power down modes during auto-negotiation looking for a link partner.</p> <p>0_B OFF ANPD is disabled. 1_B ON ANPD is enabled.</p>
LPI	0	RW	<p>Assert LPI via MDIO Controls assertion/de-assertion of the LPI by the MDIO instead of following the (X)GMII LPI. Used to force the EEE on the TPI (ignoring the LPI indication from MAC).</p> <p>0_B DE-ASSERT LPI is de-asserted on TPI. 1_B ASSERT LPI is asserted on TPI.</p>

Error Counter (Register 0.21)

This register controls the error counter. It allows the number of errors detected in the PHY to be counted for monitoring purposes.

IEEE Standard Register=0.21

PHY_ERRCNT

Reset Value

Error Counter (Register 0.21)

0000_H

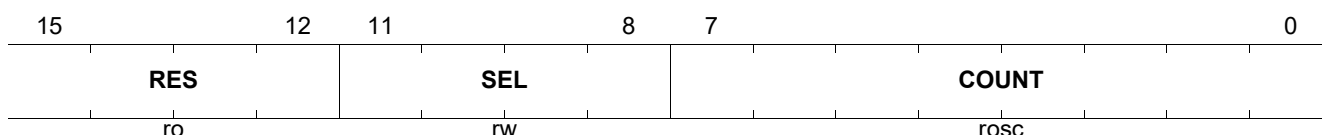

Field	Bits	Type	Description
RES	15:12	RO	Reserved Write as zero, ignored on read.
SEL	11:8	RW	Select Error Event Configures which error type the error counter counts: 0000 _B RXERR Receive errors are counted. 0001 _B RXACT Receive frames are counted. 0010 _B ESDERR ESD errors are counted. 0011 _B SSDERR SSD errors are counted. 0100 _B TXERR Transmit errors are counted. 0101 _B TXACT Transmit frames events are counted. 0110 _B COL Collision events are counted. 1000 _B NLD Number of Link Down events are counted. 1001 _B NDS Number of ADS events are counted. 1010 _B RES Reserved 1011 _B RES Reserved
COUNT	7:0	ROSC	Counter Value This counter value is updated each time the selected error event is detected. The counter value is reset every time a read operation on this register is performed or the error event is changed. The counter saturates at value FF _H .

Media-Independent Interface Status (Register 0.24)

This register contains status information on the Ethernet link, concatenated in a single register to allow concise status read by the STA in a single register.

IEEE Standard Register=0.24

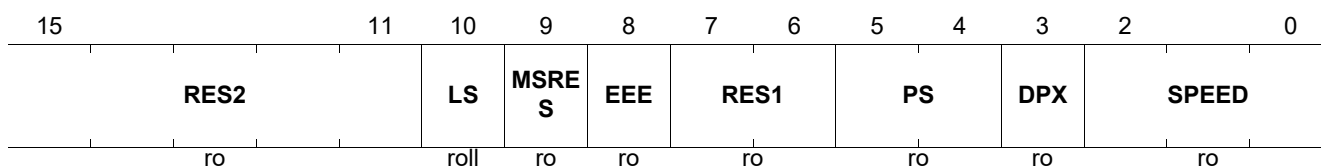
PHY_MIISTAT
Reset Value
Media-Independent Interface Status (Register 0.24)
0000_H

Field	Bits	Type	Description
RES2	15:11	RO	Reserved Write as zero, ignored on read.
LS	10	ROLL	Link Status of GPHY Ethernet PHY Operation Indicates the link status of the PHY. 0 _B INACTIVE The link is down. No communication with link partner possible. 1 _B ACTIVE The link is up. Data communication with link partner is possible.
MSRES	9	RO	Master/Slave Configuration Indicates the master/slave configuration 0 _B SLAVE Local PHY configuration is SLAVE after ANEG. 1 _B MASTER Local PHY configuration is MASTER after ANEG.
EEE	8	RO	Energy-Efficient Ethernet Mode 0 _B OFF EEE is disabled after ANEG resolution. 1 _B ON EEE is enabled after ANEG resolution.
RES1	7:6	RO	Reserved
PS	5:4	RO	Pause Status for Flow Control 00 _B NONE No PAUSE 01 _B TX Transmit PAUSE 10 _B RX Receive PAUSE 11 _B TXRX Both transmit and receive PAUSE
DPX	3	RO	GPHY Ethernet PHY Duplex Mode 0 _B HDX Half-duplex 1 _B FDX Full-duplex
SPEED	2:0	RO	GPHY Ethernet PHY Speed 000 _B TEN 10 Mbps 001 _B FAST 100 Mbps 010 _B GIGA 1000 Mbps 011 _B ANEG Auto-negotiation mode 100 _B BZZG5 2.5 Gbps

Interrupt Mask Register (Register 0.25)

This register defines the mask for the Interrupt Status Register (ISTAT), which contains the event source for the MDINT interrupt sent from the GPHY to an external chip.

The information about the interrupt source is indicated in the ISTAT register.

IEEE Standard Register=0.25

PHY_IMASK

Reset Value

Interrupt Mask Register (Register 0.25)

0000_H

15	14	13	12	11	10	9	8	7	6	5	4	3	2	1	0
WOL	MSRE	NPRX	NPTX	ANE	ANC	RES	RES	LP	TEMP	ADSC	MDIPC	MDIXC	DXMC	LSPC	LSTC
RW	RW	RW	RW	RW	RW	RW	RW	RW	RW	RW	RW	RW	RW	RW	RW

Field	Bits	Type	Description
WOL	15	RW	Wake-on-LAN Event Mask When active and masked in IMASK, the MDINT is activated upon detection of a valid WoL event. 0 _B INACTIVE Interrupt is masked out. 1 _B ACTIVE Interrupt is activated.
MSRE	14	RW	Master/Slave Resolution Error Mask When active, MDINT is activated upon detection of a master/slave resolution error (MSRE) during a 1000BASE-T ANEG. 0 _B INACTIVE Interrupt is masked out. 1 _B ACTIVE Interrupt is activated.
NPRX	13	RW	Next Page Received Mask When active, MDINT is activated upon reception of a next page in STD_AN_NPRX. 0 _B INACTIVE Interrupt is masked out. 1 _B ACTIVE Interrupt is activated.
NPTX	12	RW	Next Page Transmitted Mask When active, MDINT is activated upon transmission of the currently stored next page in STD_AN_NPTX. 0 _B INACTIVE Interrupt is masked out. 1 _B ACTIVE Interrupt is activated.
ANE	11	RW	Auto-Negotiation Error Mask When active, MDINT is activated upon detection of an ANEG error. 0 _B INACTIVE Interrupt is masked out. 1 _B ACTIVE Interrupt is activated.
ANC	10	RW	Auto-Negotiation Complete Mask When active, MDINT is activated upon completion of the ANEG process. 0 _B INACTIVE Interrupt is masked out. 1 _B ACTIVE Interrupt is activated.

Field	Bits	Type	Description (cont'd)
LP	7	RW	<p>LP Entry Indication Mask</p> <p>0_B INACTIVE Interrupt is masked out. The STA does not need to be informed of the event.</p> <p>1_B ACTIVE Interrupt is activated. The STA receives MDINT when the PHY is about to enter LP.</p>
TEMP	6	RW	<p>TEMP</p> <p>0_B INACTIVE Interrupt is masked out. The STA does not need to be informed of the event.</p> <p>1_B ACTIVE Interrupt is activated. The interrupt is triggered when the temperature goes beyond the normal operating range.</p>
ADSC	5	RW	<p>Link Speed Auto-Downspeed Detect Mask</p> <p>When active, MDINT is activated upon detection of a link speed ADS event.</p> <p>0_B INACTIVE Interrupt is masked out.</p> <p>1_B ACTIVE Interrupt is activated.</p>
MDIPC	4	RW	<p>MDI Polarity Change Detect Mask</p> <p>When active, MDINT is activated upon detection of an MDI polarity change event.</p> <p>0_B INACTIVE Interrupt is masked out.</p> <p>1_B ACTIVE Interrupt is activated.</p>
MDIXC	3	RW	<p>MDIX Change Detect Mask</p> <p>When active, MDINT is activated upon detection of an MDI/MDIX cross-over change event.</p> <p>0_B INACTIVE Interrupt is masked out.</p> <p>1_B ACTIVE Interrupt is activated.</p>
DXMC	2	RW	<p>Duplex Mode Change Mask</p> <p>When active, MDINT is activated upon detection of full or half-duplex change.</p> <p>0_B INACTIVE Interrupt is masked out.</p> <p>1_B ACTIVE Interrupt is activated.</p>
LSPC	1	RW	<p>Link Speed Change Mask</p> <p>When active, MDINT is activated upon detection of link speed change.</p> <p>0_B INACTIVE Interrupt is masked out.</p> <p>1_B ACTIVE Interrupt is activated.</p>
LSTC	0	RW	<p>Link State Change Mask</p> <p>When active, MDINT is activated upon detection of link status change.</p> <p>0_B INACTIVE Interrupt is masked out.</p> <p>1_B ACTIVE Interrupt is activated.</p>

Interrupt Status Register (Register 0.26)

This register defines the event source for the MDINT interrupt sent from the GPHY to an external chip.

PHY_ISTAT is a cleared on read by the STA.

IEEE Standard Register=0.26

PHY_ISTAT

Reset Value

Interrupt Status Register (Register 0.26)

0000_H

15	14	13	12	11	10	9	8	7	6	5	4	3	2	1	0
WOL	MSRE	NPRX	NPTX	ANE	ANC	RES	RES	LP	TEMP	ADSC	MDIPC	MDIXC	DXMC	LSPC	LSTC
ROSC	ROSC	ROSC	ROSC	ROSC	ROSC	ROSC	ROSC	ROSC	ROSC	ROSC	ROSC	ROSC	ROSC	ROSC	ROSC

Field	Bits	Type	Description
WOL	15	ROSC	Wake-on-LAN Interrupt Status When this bit is set, the MDINT is activated upon detection of a valid WoL event. 0 _B INACTIVE This event is not the interrupt source. 1 _B ACTIVE The WoL event is the source of the interrupt.
MSRE	14	ROSC	Master/Slave Resolution Error Interrupt Status When this bit is set, the MDINT is activated upon detection of a MSRE during a 1000BASE-T ANEG. 0 _B INACTIVE This event is not the interrupt source. 1 _B ACTIVE The MSRE event is the source of the interrupt.
NPRX	13	ROSC	Next Page Received Interrupt Status When this bit is set, the MDINT is activated upon reception of a next page in STD_AN_NPRX. 0 _B INACTIVE This event is not the interrupt source. 1 _B ACTIVE The NPRX event is the source of the interrupt.
NPTX	12	ROSC	Next Page Transmitted Interrupt Status When this bit is set, the MDINT is activated upon transmission of the currently stored next page in STD_AN_NPTX. 0 _B INACTIVE This event is not the interrupt source. 1 _B ACTIVE The NPTX event is the source of the interrupt.
ANE	11	ROSC	Auto-Negotiation Error Interrupt Status When this bit is set, the MDINT is activated upon detection of an ANEG error. 0 _B INACTIVE This event is not the interrupt source. 1 _B ACTIVE The ANEG error event is the source of the interrupt.
ANC	10	ROSC	Auto-Negotiation Complete Interrupt Status When this bit is set, the MDINT is activated upon completion of the ANEG process. 0 _B INACTIVE This event is not the interrupt source. 1 _B ACTIVE The ANEG complete event is the source of the interrupt.

Field	Bits	Type	Description (cont'd)
LP	7	ROSC	LP Entry Indication 0 _B INACTIVE No indication of LP entry 1 _B ACTIVE Indication of LP entry.
TEMP	6	ROSC	TEMP Indicates that thermal mitigation action must be taken when the temperature goes beyond the normal operating range. The GPHY implements ADS by default when this happens, but it is possible to disable ADS. When the SoC disables ADS, it is recommended that the SoC initiates a link down and changes the speed capability to cool the device back to the normal temperature range. When the temperature reaches the maximum absolute rating, the device resets for safety purposes. Thermal mitigation must ensure that the maximum absolute temperature limits are never reached. 0 _B INACTIVE This event is not the interrupt source. 1 _B ACTIVE The TEMP change event is the source of the interrupt.
ADSC	5	ROSC	Link Speed Auto-Downspeed Detect Interrupt Status When this bit is set, the MDINT is activated upon detection of a link speed ADS event. 0 _B INACTIVE This event is not the interrupt source. 1 _B ACTIVE The ADSC change event is the source of the interrupt.
MDIPC	4	ROSC	MDI Polarity Change Detect Interrupt Status When this bit is set, the MDINT is activated upon detection of an MDI polarity change event. 0 _B INACTIVE This event is not the interrupt source. 1 _B ACTIVE The MDIPC change event is the source of the interrupt.
MDIXC	3	ROSC	MDIX Change Detect Interrupt Status When this bit is set, the MDINT is activated upon detection of an MDI/MDIX cross-over change event. 0 _B INACTIVE This event is not the interrupt source. 1 _B ACTIVE The MDIX change event is the source of the interrupt.
DXMC	2	ROSC	Duplex Mode Change Interrupt Status When this bit is set, the MDINT is activated upon detection of a full or half-duplex change. 0 _B INACTIVE This event is not the interrupt source. 1 _B ACTIVE The DXMC change event is the source of the interrupt.
LSPC	1	ROSC	Link Speed Change Interrupt Status When this bit is set, the MDINT is activated upon detection of link speed change. 0 _B INACTIVE This event is not the interrupt source. 1 _B ACTIVE The LSPC change event is the source of the interrupt.
LSTC	0	ROSC	Link State Change Interrupt Status When this bit is set, the MDINT is activated upon detection of link status change. 0 _B INACTIVE This event is not the interrupt source. 1 _B ACTIVE The LSTC change event is the source of the interrupt.

LED Control Register (Register 0.27)

This register contains the control bits for direct access to the LEDs by setting the on/off LEDxDA bits (where x is from 0 to 2).

To directly control the LED, the integrated LED functions must be disabled by the LEDxEN bit in this register.

The integrated LED functions are specified in the more sophisticated LED control registers in the MMD device VSPEC1.

IEEE Standard Register=0.27

PHY_LED

LED Control Register (Register 0.27)

Reset Value

FF00_H

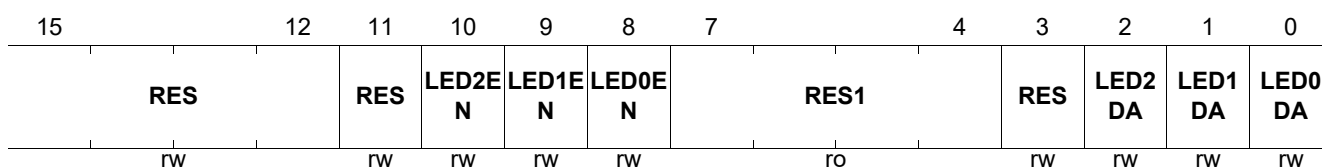

Field	Bits	Type	Description
RES	15:12	RW	Reserved The default value must not be changed.
LED2EN	10	RW	Enable Integrated Function of LED2 Write a 0 to this bit to disable the pre-configured integrated function for this LED. The LED remains off unless directly accessed via LED2DA. 0 _B DISABLE Disables the integrated LED function. 1 _B ENABLE Enables the integrated LED function.
LED1EN	9	RW	Enable Integrated Function of LED1 Write a 0 to this bit to disable the pre-configured integrated function for this LED. The LED remains off unless directly accessed via LED1DA. 0 _B DISABLE Disables the integrated LED function. 1 _B ENABLE Enables the integrated LED function.
LED0EN	8	RW	Enable Integrated Function of LED0 Write a 0 to this bit to disable the pre-configured integrated function for this LED. The LED remains off unless directly accessed via LED0DA. 0 _B DISABLE Disables the integrated LED function. 1 _B ENABLE Enables the integrated LED function.
RES1	7:4	RO	Reserved Write as zero, ignored on read.
LED2DA	2	RW	Direct Access to LED2 Write a 1 to this bit to illuminate the LED. LED2EN must be set to zero. 0 _B OFF Switch off the LED. 1 _B ON Switch on the LED.
LED1DA	1	RW	Direct Access to LED1 Write a 1 to this bit to illuminate the LED. LED1EN must be set to zero. 0 _B OFF Switch off the LED. 1 _B ON Switch on the LED.

Field	Bits	Type	Description (cont'd)
LED0DA	0	RW	Direct Access to LED0 Write a 1 to this bit to illuminate the LED. LED0EN must be set to zero. 0 _B OFF Switch off the LED. 1 _B ON Switch on the LED.

Test-Packet Generator Control (Register 0.28)

This register controls the operation of the integrated Test-Packet Generator (TPG). This module is only used for testing purposes.

IEEE Standard Register=0.28

PHY_TPGCTRL

Reset Value

Test-Packet Generator Control (Register 0.28)

0000_H

15	14	13	12	11	10	9	8	7	6	4	3	2	1	0
RES		MODE	RES3	IPGL		TYPE		RES2	SIZE			RES1	START	EN
rw		rw	ro	rw		rw		ro	rw			ro	rw	rw

Field	Bits	Type	Description
RES	15:14	RW	Reserved Write as zero, ignore on read.
MODE	13	RW	TPG Mode Configures the packet generation mode. 0 _B CONTINUOUS Sends packets continuously. 1 _B SINGLE Sends a single packet.
RES3	12	RO	Reserved Write as zero, ignore on read.
IPGL	11:10	RW	Inter-Packet Gap Length Configures the length of the inter-packet gap in bit times. 00 _B RES Reserved 01 _B BT96 Length is 96 bit times 10 _B BT960 Length is 960 bit times 11 _B BT9600 Length is 9600 bit times
TYPE	9:8	RW	Packet Data Type Configures the packet data type to be either predefined, byte increment, or random. When predefined, the content of the register TPGDATA is used. 00 _B RANDOM Uses random data as the packet content. 01 _B BYTEINC Uses byte increment as the packet content. 10 _B PREDEF Uses predefined content of the register TPGDATA. 11 _B RES Reserved.
RES2	7	RO	Reserved. Write as zero, ignore on read.

Field	Bits	Type	Description (cont'd)
SIZE	6:4	RW	<p>Packet Size Configures the size of the generated Ethernet packets in bytes. The size includes DA, SA, length/type, payload, and FCS.</p> <p>000_B B64 Packet length is 64 bytes 001_B B2048 Packet length is 2048 bytes 010_B B256 Packet length is 256 bytes 011_B B4096 Packet length is 4096 bytes 100_B B1024 Packet length is 1024 bytes 101_B B1518 Packet length is 1518 bytes 110_B B9000 Packet length is 9000 bytes</p>
RES1	3:2	RO	<p>Reserved Write as zero, ignore on read.</p>
START	1	RW	<p>Start or Stop TPG Data Generation. Starts the TPG data generation. Depending on the MODE, the TPG sends only one packet or chunks of 10000 packets until stopped.</p> <p>0_B STOP Stops the TPG data generation. 1_B START Starts the TPG data generation.</p>
EN	0	RW	<p>Enable the TPG Enables the TPG for data generation.</p> <p>0_B DISABLE Disables the TPG 1_B ENABLE Enables the TPG</p>

Test-Packet Generator Data (Register 0.29)

Specifies the payload data to be used when sending a non-random data packet. All payload data bytes are sent with this value.

IEEE Standard Register=0.29

PHY_TPGDATA

Reset Value

Test-Packet Generator Data (Register 0.29)

00AA_H

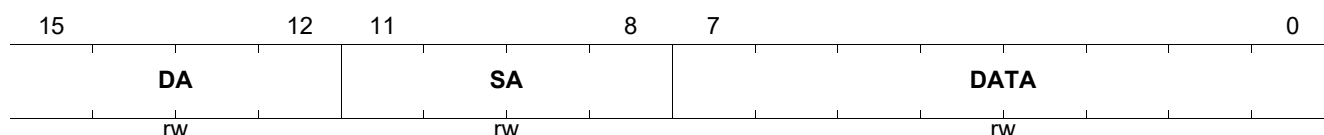

Field	Bits	Type	Description
DA	15:12	RW	Destination Address Configures the destination address nibble. The destination address builds up to 00-03-19-FF-FF-F[DA].
SA	11:8	RW	Source Address Configures the source address nibble. The source address builds up to 00-03-19-FF-FF-F[SA].
DATA	7:0	RW	Data Byte to be Transmitted This is the content of the payload bytes in the frame to send constant data. The bit masks are shown here. For configuration details, refer to the corresponding chapter. 80 _H PREC Selects whether to take full precision (1) or reduced precision (0) at bit 7 60 _H PREC2 For reduced precision, selects the options with bits [6:5] 10 _H RESERVED Reserved

Firmware Version Register (Register 0.30)

This register contains the version of the PHY firmware. The firmware initializes the version number at boot time with its current software version. This register is read-only by the external STA.

IEEE Standard Register=0.30

PHY_FWV

Reset Value

Firmware Version Register (Register 0.30)

0000_H

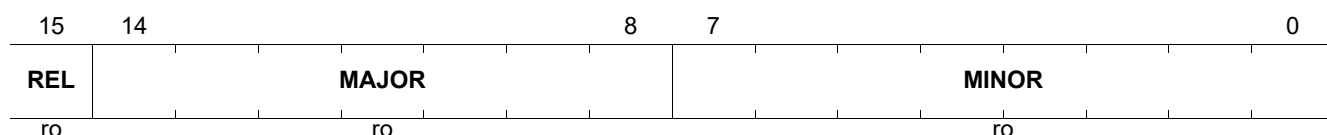

Field	Bits	Type	Description
REL	15	RO	Release Indication This parameter indicates either a test or a release version. 0 _B TEST Indicates a test version. 1 _B RELEASE Indicates a released version.
MAJOR	14:8	RO	Major Version Number Specifies the main version release number of the firmware.
MINOR	7:0	RO	Minor Version Number Specifies the sub-version release number of the firmware.

6 PHY MMD Registers Detailed Description

Table 33 Register Access Type

Mode	Symbol
Status Register (Status or Ability Register)	RO
Read-Write Register (MDIO Register)	RW
Read-Write Self-Clearing Register (bit is cleared after read from MDIO)	RWSC
Read-Only Self-Clearing Register (bit is cleared after read from MDIO)	ROSC

6.1 Standard PMAPMD Registers for MMD=0x01

Table 34 Registers Overview- Standard PMAPMD Registers

Register Short Name	Register Long Name	Reset Value
PMA_CTRL1	PMA/PMD Control 1 (Register 1.0)	2058 _H
PMA_STAT1	PMA/PMD Status 1 (Register 1.1)	0000 _H
PMA_DEVID1	PHY Identifier 1 (Register 1.2)	C133 _H
PMA_DEVID2	PHY Identifier 2 (Register 1.3)	5400 _H ¹⁾
PMA_SPEED_ABILITY	PMA/PMD Speed Ability (Register 1.4)	2070 _H
PMA_DIP1	Devices in Package 1 (Register 1.5)	008B _H
PMA_DIP2	Devices in Package 2 (Register 1.6)	C000 _H
PMA_CTL2	PMA/PMD Control 2 (Register 1.7)	0030 _H
PMA_STAT2	PMA/PMD Status 2 (Register 1.8)	8200 _H
PMA_EXT_ABILITY	PMA/PMD Extended Ability (Register 1.11)	41A0 _H
PMA_PACKID1	AN Package Identifier (Register 1.14)	C133 _H
PMA_PACKID2	AN Package Identifier (Register 1.15)	5400 _H ¹⁾
PMA_MGBT_EXTAB	PMAPMD Extended Ability (Register 1.21)	0001 _H
PMA_MGBT_STAT	MULTIGBASE-T Status (Register 1.129)	0000 _H
PMA_MGBT_POLARITY	MULTIGBASE-T Pair Swap and Polarity (Register 1.130)	0003 _H
PMA_MGBT_TX_PBO	MULTIGBASE-T Tx Power Backoff and PHY Short Reach Setting (Register 1.131)	0000 _H
PMA_MGBT_TEST_MODE	MULTIGBASE-T Test Mode (Register 1.132)	0000 _H
PMA_MGBT_SNR_OPMARGIN_A	MULTIGBASE-T SNR Margin Channel A (Register 1.133)	0000 _H
PMA_MGBT_SNR_OPMARGIN_B	MULTIGBASE-T SNR Margin Channel B (Register 1.134)	0000 _H
PMA_MGBT_SNR_OPMARGIN_C	MULTIGBASE-T SNR Margin Channel C (Register 1.135)	0000 _H
PMA_MGBT_SNR_OPMARGIN_D	MULTIGBASE-T SNR Margin Channel D (Register 1.136)	0000 _H
PMA_MGBT_MINMARGIN_A	MULTIGBASE-T SNR Minimum Margin Channel A (Register 1.137)	0000 _H
PMA_MGBT_MINMARGIN_B	MULTIGBASE-T SNR Minimum Margin Channel B (Register 1.138)	0000 _H
PMA_MGBT_MINMARGIN_C	MULTIGBASE-T SNR Minimum Margin Chan C (Register 1.139)	0000 _H
PMA_MGBT_MINMARGIN_D	MULTIGBASE-T SNR Minimum Margin Chan D (Register 1.140)	0000 _H
PMA_MGBT_POWER_A	MULTIGBASE-T Rx Power Channel A (Register 1.141)	0000 _H
PMA_MGBT_POWER_B	MULTIGBASE-T Rx Power Channel B (Register 1.142)	0000 _H
PMA_MGBT_POWER_C	MULTIGBASE-T Rx Power Chan C (Register 1.143)	0000 _H
PMA_MGBT_POWER_D	MULTIGBASE-T Rx Power Chan D (Register 1.144)	0000 _H
PMA_MGBT_SKEW_DELAY_0	MULTIGBASE-T Skew Delay 0 (Register 1.145)	0000 _H
PMA_MGBT_SKEW_DELAY_1	MULTIGBASE-T Skew Delay 1 (Register 1.146)	0000 _H

Table 34 Registers Overview- Standard PMAPMD Registers (cont'd)

Register Short Name	Register Long Name	Reset Value
PMA_MGBT_FAST_RETRAIN_STA_CTRL	MULTIGBASE-T Skew Delay 2 (Register 1.147)	0010 _H
PMA_TIMESYNC_CAP	PMA TimeSync Capability Indication (Register 1.1800)	0000 _H

1) For the device specific reset value, see the Product and Package Naming table in the [Product Ordering Information](#) chapter.

6.1.1 PMAPMD Register Descriptions

This section describes all the PMAPMD registers in detail.

PMA/PMD Control 1 (Register 1.0)

IEEE Standard Register=1.0

PMA_CTRL1

PMA/PMD Control 1 (Register 1.0)

Reset Value

2058_H

15	14	13	12	11	10	7	6	5	2	1	0
RST	RES	SSL	RES	LOW_POWER*		RES	SSM		SPEED_SEL	NS1	NS2
RW		RW		RW			RW		RW	RO	RO

Field	Bits	Type	Description
RST	15	RW	Reset 0 _B Normal operation 1 _B PMA/PMD reset
SSL	13	RW	Speed Selection (LSB) Used in conjunction with field SPEED_SEL_MSB. MSB LSB: 00 _B 10 Mbps 01 _B 100 Mbps 10 _B 1000 Mbps 11 _B Bits [5:2] select the speed (SPEED_SEL field)
LOW_POWER	11	RW	Low Power 0 _B Normal operation 1 _B Enters low power mode.
SSM	6	RW	Speed Selection (MSB) Used in conjunction with field SPEED_SEL_LSB. MSB LSB: 00 _B 10 Mbps 01 _B 100 Mbps 10 _B 1000 Mbps 11 _B Bits [5:2] select the speed (SPEED_SEL field)
SPEED_SEL	5:2	RW	Speed Selection Bit usage (from bit 5 to bit 2): 0 0 0 0 _B Not supported. The speed defaults to 2.5 Gbps. 0 0 0 1 _B Not supported. The speed defaults to 2.5 Gbps. 0 0 1 0 _B Not supported. The speed defaults to 2.5 Gbps. 0 0 1 1 _B Not supported. The speed defaults to 2.5 Gbps. 0 1 0 0 _B Not supported. The speed defaults to 2.5 Gbps. 0 1 0 1 _B Not supported. The speed defaults to 2.5 Gbps. 0 1 1 0 _B 2.5 Gbps 0 1 1 1 _B Not supported 1 x x x _B Reserved

Field	Bits	Type	Description (cont'd)
NS1	1	RO	Not Supported PMA remote loopback mode is not supported by the GPHY.
NS2	0	RO	Not Supported PMA local loopback mode is not supported by the GPHY.

PMA/PMD Status 1 (Register 1.1)

IEEE Standard Register=1.1

PMA_STAT1

PMA/PMD Status 1 (Register 1.1)

Reset Value

0000_H

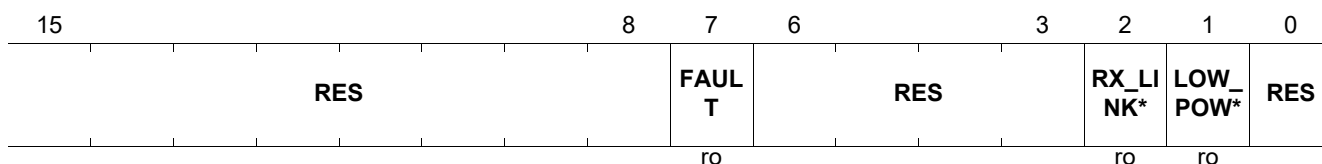

Field	Bits	Type	Description
FAULT	7	RO	Fault 0 _B Fault condition not detected 1 _B Fault condition detected
RX_LINK_STATUS	2	RO	Receive Link Status 0 _B PMA/PMD receive link down 1 _B PMA/PMD receive link up
LOW_POWER_ABILITY	1	RO	Low Power Ability 0 _B PMA/PMD does not support low power mode. 1 _B PMA/PMD supports low power mode.

PHY Identifier 1 (Register 1.2)

IEEE Standard Register=1.2

Bits 31 - 16 of device ID

PMA_DEVID1

Reset Value

PHY Identifier 1 (Register 1.2)

C133_H

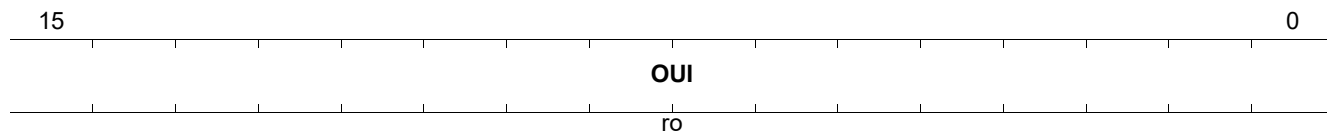

Field	Bits	Type	Description
OUI	15:0	RO	Organizationally Unique Identifier Organizationally Unique Identifier Bits 3:18

PHY Identifier 2 (Register 1.3)

IEEE Standard Register=1.3

Bits 15 - 0 of device ID

PMA_DEVID2

Reset Value

PHY Identifier 2 (Register 1.3)

5400_H



Field	Bits	Type	Description
OUI	15:10	RO	Organizationally Unique Identifier Bits 19:24
LDN	9:4	RO	Device Number Specifies the device number ¹⁾ to distinguish between several different products.
LDRN	3:0	RO	Device Revision Number Specifies the device revision number ¹⁾ to distinguish between several versions of this device.

1) For the device specific reset value, see the Product and Package Naming table in the [Product Ordering Information](#) chapter.

PMA/PMD Speed Ability (Register 1.4)

IEEE Standard Register=1.4

PMA_SPEED_ABILITY
Reset Value
PMA/PMD Speed Ability (Register 1.4)
2070_H

15	14	13	12	11	10	9	8	7	6	5	4	3	2	1	0
RES	CAP_5G	CAP_2G5	RES2	RES	RES	CAP_100G	CAP_40G	CAP_10_1G*	CAP_10M	CAP_100M	CAP_1000M	RES	R10PASS*	CAP_2BA*	CAP_10G*
	ro	ro	ro			ro	ro	ro	ro	ro	ro		ro	ro	ro

Field	Bits	Type	Description
CAP_5G	14	RO	Not Supported 0 _B PMA/PMD is not capable of operating as 5 Gbps. 1 _B PMA/PMD is capable of operating at 5 Gbps.
CAP_2G5	13	RO	2.5 G capable 0 _B PMA/PMD is not capable of operating as 2.5 Gbps. 1 _B PMA/PMD is capable of operating at 2.5 Gbps.
RES2	12	RO	Reserved Value always 0
CAP_100G	9	RO	Not Supported 0 _B PMA/PMD is not capable of operating as 100 Gbps. 1 _B PMA/PMD is capable of operating at 100 Gbps.
CAP_40G	8	RO	Not Supported 0 _B PMA/PMD is not capable of operating as 40 Gbps. 1 _B PMA/PMD is capable of operating at 40 Gbps.
CAP_10_1G	7	RO	Not Supported 0 _B PMA/PMD is not capable of operating at 10 Gbps downstream and 1 Gbps upstream. 1 _B PMA/PMD is capable of operating at 10 Gbps downstream and 1 Gbps upstream.
CAP_10M	6	RO	10M capable 0 _B PMA/PMD is not capable of operating as 10 Mbps. 1 _B PMA/PMD is capable of operating at 10 Mbps.
CAP_100M	5	RO	100M capable 0 _B PMA/PMD is not capable of operating as 100 Mbps. 1 _B PMA/PMD is capable of operating at 100 Mbps.
CAP_1000M	4	RO	1000M capable 0 _B PMA/PMD is not capable of operating as 1000 Mbps. 1 _B PMA/PMD is capable of operating at 1000 Mbps.
R10PASS_TS_CAPABLE	2	RO	Not Supported 0 _B PMA/PMD is not capable of operating as 10PASS-TS. 1 _B PMA/PMD is capable of operating as 10PASS-TS.

Field	Bits	Type	Description (cont'd)
CAP_2BASE_TL	1	RO	Not Supported 0 _B PMA/PMD is not capable of operating as 2BASE-TL. 1 _B PMA/PMD is capable of operating as 2BASE-TL.
CAP_10G_CAPP	0	RO	Not Supported 0 _B PMA/PMD is not capable of operating at 10 Gbps. 1 _B PMA/PMD is capable of operating at 10 Gbps.

Field	Bits	Type	Description (cont'd)
WIS	2	RO	WIS Present 0 _B WIS not present in package 1 _B WIS present in package
PMD_PMA	1	RO	PMD/PMA Present This bit is always set to 1 _B in the GPHY. 0 _B PMA/PMD not present in package 1 _B PMA/PMD present in package
CLAUSE_22	0	RO	Clause 22 Registers Present This bit is always set to 1 _B in the GPHY. 0 _B Clause 22 registers not present in package 1 _B Clause 22 registers present in package

Devices in Package 2 (Register 1.6)

IEEE Standard Register=1.6

PMA_DIP2

Reset Value

Devices in Package 2 (Register 1.6)

C000_H

15	14	13	12								0
VSPE C2	VSPE C1	CLA_2 2_*	RES								
ro	ro	ro	ro								

Field	Bits	Type	Description
VSPEC2	15	RO	Vendor-specific Device 2 This bit is always set to 1 _B in the GPHY. 0 _B Vendor-specific device 2 not present in package 1 _B Vendor-specific device 2 present in package
VSPEC1	14	RO	Vendor-specific Device 1 This bit is always set to 1 _B in the GPHY. 0 _B Vendor-specific device 1 not present in package 1 _B Vendor-specific device 1 present in package
CLA_22_EXT	13	RO	Clause 22 Extension 0 _B Clause 22 extension not present in package 1 _B Clause 22 extension present in package
RES	12:0	RO	Reserved Ignore on read.

PMA/PMD Control 2 (Register 1.7)

IEEE Standard Register=1.7

PMA_CTL2

PMA/PMD Control 2 (Register 1.7)

Reset Value

0030_H

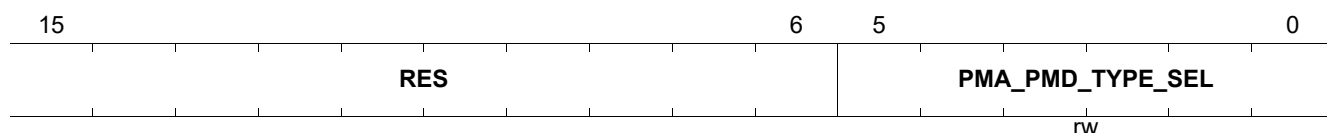

Field	Bits	Type	Description
PMA_PMD_TY PE_SEL	5:0	RW	<p>PMA/PMD Type Selection</p> <p>5 4 3 2 1 0</p> <p>Others = Reserved</p> <p>1 1 0 0 0 1_B Unsupported, defaults to 2.5GBASE-T PMA</p> <p>1 1 0 0 0 0_B 2.5GBASE-T PMA</p> <p>1 0 1 1 x_B Unsupported, defaults to 2.5GBASE-T PMA</p> <p>1 0 1 0 1 1_B Unsupported, defaults to 2.5GBASE-T PMA</p> <p>1 0 1 0 1 0_B Unsupported, defaults to 2.5GBASE-T PMA</p> <p>1 0 1 0 0 1_B Unsupported, defaults to 2.5GBASE-T PMA</p> <p>1 0 1 0 0 0_B Unsupported, defaults to 2.5GBASE-T PMA</p> <p>1 0 0 1 1 x_B Unsupported, defaults to 2.5GBASE-T PMA</p> <p>1 0 0 1 0 1_B Unsupported, defaults to 2.5GBASE-T PMA</p> <p>1 0 0 1 0 0_B Unsupported, defaults to 2.5GBASE-T PMA</p> <p>1 0 0 0 1 1_B Unsupported, defaults to 2.5GBASE-T PMA</p> <p>1 0 0 0 1 0_B Unsupported, defaults to 2.5GBASE-T PMA</p> <p>1 0 0 0 0 1_B Unsupported, defaults to 2.5GBASE-T PMA</p> <p>1 0 0 0 0 0_B Unsupported, defaults to 2.5GBASE-T PMA</p> <p>0 1 1 1 x_B Unsupported, defaults to 2.5GBASE-T PMA</p> <p>0 1 1 0 1 1_B Unsupported, defaults to 2.5GBASE-T PMA</p> <p>0 1 1 0 1 0_B Unsupported, defaults to 2.5GBASE-T PMA</p> <p>0 1 1 0 0 1_B Unsupported, defaults to 2.5GBASE-T PMA</p> <p>0 1 1 0 0 0_B Unsupported, defaults to 2.5GBASE-T PMA</p> <p>0 1 0 1 1 1_B Unsupported, defaults to 2.5GBASE-T PMA</p> <p>0 1 0 1 1 0_B Unsupported, defaults to 2.5GBASE-T PMA</p> <p>0 1 0 1 0 1_B Unsupported, defaults to 2.5GBASE-T PMA</p> <p>0 1 0 1 0 0_B Unsupported, defaults to 2.5GBASE-T PMA</p> <p>0 1 0 0 1 1_B Unsupported, defaults to 2.5GBASE-T PMA</p> <p>0 1 0 0 1 0_B Unsupported, defaults to 2.5GBASE-T PMA</p> <p>0 1 0 0 0 1_B Unsupported, defaults to 2.5GBASE-T PMA</p> <p>0 1 0 0 0 0_B Unsupported, defaults to 2.5GBASE-T PMA</p>

Field	Bits	Type	Description (cont'd)
PMA_PMD_TY PE_SEL	5:0	RW	PMA/PMD Type Selection (cont'd) 0 0 1 1 1 1 _B 10BASE-T PMA/PMD 0 0 1 1 1 0 _B 100BASE-TX PMA/PMD 0 0 1 1 0 1 _B Unsupported, defaults to 2.5GBASE-T PMA 0 0 1 1 0 0 _B 1000BASE-T PMA/PMD 0 0 1 0 1 1 _B Unsupported, defaults to 2.5GBASE-T PMA 0 0 1 0 1 0 _B Unsupported, defaults to 2.5GBASE-T PMA 0 0 1 0 0 1 _B Unsupported, defaults to 2.5GBASE-T PMA 0 0 1 0 0 0 _B Unsupported, defaults to 2.5GBASE-T PMA 0 0 0 1 1 1 _B Unsupported, defaults to 2.5GBASE-T PMA 0 0 0 1 1 0 _B Unsupported, defaults to 2.5GBASE-T PMA 0 0 0 1 0 1 _B Unsupported, defaults to 2.5GBASE-T PMA 0 0 0 1 0 0 _B Unsupported, defaults to 2.5GBASE-T PMA 0 0 0 0 1 1 _B Unsupported, defaults to 2.5GBASE-T PMA 0 0 0 0 1 0 _B Unsupported, defaults to 2.5GBASE-T PMA 0 0 0 0 0 1 _B Unsupported, defaults to 2.5GBASE-T PMA 0 0 0 0 0 0 _B Unsupported, defaults to 2.5GBASE-T PMA

PMA/PMD Status 2 (Register 1.8)

IEEE Standard Register=1.8

PMA_STAT2

PMA/PMD Status 2 (Register 1.8)

Reset Value

8200_H

15	14	13	12	11	10	9	8	7	6	5	4	3	2	1	0
DEVICE_PRESENT	TX_FAULT*	RX_FAULT*	TX_FAULT	RX_FAULT	EXT_ABILITY*	PMD_TX_DISABLE*	RMGBT_SR_ABILITY*	RMGBT_LR_ABILITY*	RMGBT_ER_ABILITY*	RMGBT_SR_ABILITY*	RMGBT_LR_ABILITY*	RMGBT_ER_ABILITY*	RMGBT_SR_ABILITY*	RMGBT_LR_ABILITY*	PMA_LOC*
ro	ro	ro	ro	ro	ro	ro	ro	ro	ro	ro	ro	ro	ro	ro	ro

Field	Bits	Type	Description
DEVICE_PRESENT	15:14	RO	Device Present 00 _B No device responding at this address 01 _B No device responding at this address 10 _B Device responding at this address 11 _B No device responding at this address
TX_FAULT_ABILITY	13	RO	Transmit Fault Ability 0 _B PMA/PMD is not able to detect a fault condition on the transmit path. 1 _B PMA/PMD is able to detect a fault condition on the transmit path.
RX_FAULT_ABILITY	12	RO	Receive Fault Ability 0 _B PMA/PMD is not able to detect a fault condition on the receive path. 1 _B PMA/PMD is able to detect a fault condition on the receive path.
TX_FAULT	11	RO	Transmit Fault 0 _B No fault condition on transmit path 1 _B Fault condition on transmit path
RX_FAULT	10	RO	Receive Fault 0 _B No fault condition on receive path 1 _B Fault condition on receive path
EXT_ABILITIES	9	RO	Extended Abilities 0 _B PMA/PMD does not have extended abilities. 1 _B PMA/PMD has extended abilities listed in register 1.11.
PMD_TX_DISABLE	8	RO	PMD Transmit Disable 0 _B PMD is not able to disable the transmit path. 1 _B PMD is able to disable the transmit path.
RMGBT_SR_ABILITY	7	RO	MULTIGBASE-SR Ability 0 _B PMA/PMD is not able to perform MULTIGBASE-SR. 1 _B PMA/PMD is able to perform MULTIGBASE-SR.
RMGBT_LR_ABILITY	6	RO	MULTIGBASE-LR Ability 0 _B PMA/PMD is not able to perform MULTIGBASE-LR. 1 _B PMA/PMD is able to perform MULTIGBASE-LR.
RMGBT_ER_ABILITY	5	RO	MULTIGBASE-ER Ability 0 _B PMA/PMD is not able to perform MULTIGBASE-ER. 1 _B PMA/PMD is able to perform MULTIGBASE-ER.

Field	Bits	Type	Description (cont'd)
RMGBT_LX4_ABILITY	4	RO	MULTIGBASE-LX4 Ability 0 _B PMA/PMD is not able to perform MULTIGBASE-LX4. 1 _B PMA/PMD is able to perform MULTIGBASE-LX4.
RMGBT_SW_ABILITY	3	RO	MULTIGBASE-SW Ability 0 _B PMA/PMD is not able to perform MULTIGBASE-SW. 1 _B PMA/PMD is able to perform MULTIGBASE-SW.
RMGBT_LW_ABILITY	2	RO	MULTIGBASE-LW Ability 0 _B PMA/PMD is not able to perform MULTIGBASE-LW. 1 _B PMA/PMD is able to perform MULTIGBASE-LW.
RMGBT_EW_ABILITY	1	RO	MULTIGBASE-EW Ability 0 _B PMA/PMD is not able to perform MULTIGBASE-EW. 1 _B PMA/PMD is able to perform MULTIGBASE-EW.
PMA_LOCAL_LOOPBACK	0	RO	PMA Local Loopback 0 _B PMA is not able to perform a local loopback function. 1 _B PMA is able to perform a local loopback function.

PMA/PMD Extended Ability (Register 1.11)

IEEE Standard Register=1.11

PMA_EXT_ABILITY
PMA/PMD Extended Ability (Register 1.11)
Reset Value
41A0_H

15	14	13		11	10	9	8	7	6	5	4	3	2	1	0
RES	R2G5_EX*		RES		R40G_10*	P2MP_AB*	R10B_ASE*	R100B_AS*	R1000_BA*	R1000_BA*	RMGB_T_K*	RMGB_T_K*	RMGB_T_A*	RMGB_T_L*	RMGB_T_C*
	ro				ro	ro	ro	ro	ro	ro	ro	ro	ro	ro	ro

Field	Bits	Type	Description
R2G5_EXT_ABILITIES	14	RO	2.5G/5G Extended Abilities 0 _B PMA/PMD does not have 2.5G/5G extended abilities. 1 _B PMA/PMD has 2.5G/5G extended abilities listed in register 1.21.
R40G_100G_EXT_ABILITIES	10	RO	40G/100G Extended Abilities 0 _B PMA/PMD does not have 40G/100G extended abilities. 1 _B PMA/PMD has 40G/100G extended abilities listed in register 1.13.
P2MP_ABILITY	9	RO	P2MP Ability 0 _B PMA/PMD does not have P2MP extended abilities. 1 _B PMA/PMD has P2MP abilities listed in register 1.12.
R10BASE_T_ABILITY	8	RO	10BASE-T Ability 0 _B PMA/PMD is not able to perform 10BASE-T. 1 _B PMA/PMD is able to perform 10BASE-T.
R100BASE_TX_ABILITY	7	RO	100BASE-TX Ability 0 _B PMA/PMD is not able to perform 100BASE-TX. 1 _B PMA/PMD is able to perform 100BASE-TX.
R1000BASE_KX_ABILITY	6	RO	1000BASE-KX Ability 0 _B PMA/PMD is not able to perform 1000BASE-KX. 1 _B PMA/PMD is able to perform 1000BASE-KX.
R1000BASE_T_ABILITY	5	RO	1000BASE-T Ability 0 _B PMA/PMD is not able to perform 1000BASE-T. 1 _B PMA/PMD is able to perform 1000BASE-T.
RMGBT_KR_ABILITY	4	RO	MULTIGBASE-KR Ability 0 _B PMA/PMD is not able to perform MULTIGBASE-KR. 1 _B PMA/PMD is able to perform MULTIGBASE-KR.
RMGBT_KX4_ABILITY	3	RO	MULTIGBASE-KX4 Ability 0 _B PMA/PMD is not able to perform MULTIGBASE-KX4. 1 _B PMA/PMD is able to perform MULTIGBASE-KX4.
RMGBT_ABILITY	2	RO	10GBASE-T Ability 0 _B PMA/PMD is not able to perform MULTIGBASE-T. 1 _B PMA/PMD is able to perform MULTIGBASE-T.
RMGBT_LRM_ABILITY	1	RO	MULTIGBASE-LRM Ability 0 _B PMA/PMD is not able to perform MULTIGBASE-LRM. 1 _B PMA/PMD is able to perform MULTIGBASE-LRM.

Field	Bits	Type	Description (cont'd)
RMGBT_CX4_ABILITY	0	RO	MULTIGBASE-CX4 Ability 0 _B PMA/PMD is not able to perform MULTIGBASE-CX4. 1 _B PMA/PMD is able to perform MULTIGBASE-CX4.

AN Package Identifier (Register 1.14)

IEEE Standard Register=1.14

PMA_PACKID1

Reset Value

AN Package Identifier (Register 1.14)

C133_H

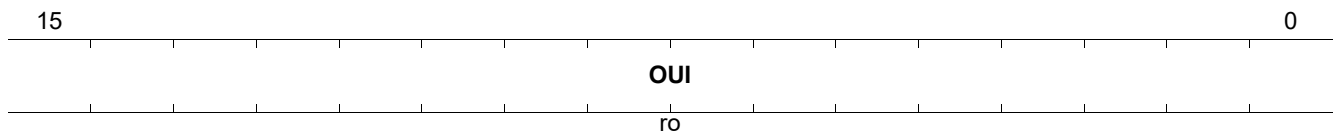

Field	Bits	Type	Description
OUI	15:0	RO	Organizationally Unique Identifier Organizationally Unique Identifier Bits 3:18

AN Package Identifier (Register 1.15)

IEEE Standard Register=1.15

PMA_PACKID2

AN Package Identifier (Register 1.15)

Reset Value

5400_H

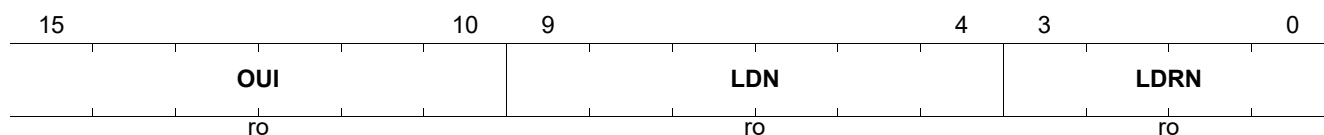

Field	Bits	Type	Description
OUI	15:10	RO	Organizationally Unique Identifier Bits 19:24
LDN	9:4	RO	Device Number Specifies the device number ¹⁾ to distinguish between several different products.
LDRN	3:0	RO	Device Revision Number Specifies the device revision number ¹⁾ to distinguish between several versions of this device.

1) For the device specific reset value, see the Product and Package Naming table in the [Product Ordering Information](#) chapter.

PMA_PMD Extended Ability (Register 1.21)

Read only. Write from the STA has no effect.

IEEE Standard Register=1.21

PMA_MGBT_EXTAB

Reset Value

PMA_PMD Extended Ability (Register 1.21)

0001_H



Field	Bits	Type	Description
RES	15:2	RO	Reserved Value always 0
AB5G	1	RO	PMA Ability to Perform 5GBASE-T 0 _B UNABLE PMA is not able to perform 5GBASE-T. 1 _B ABLE PMA is able to perform 5GBASE-T.
AB2G5	0	RO	PMA Ability to Perform 2.5GBASE-T 0 _B UNABLE PMA is not able to perform 2.5GBASE-T. 1 _B ABLE PMA is able to perform 2.5GBASE-T.

MULTIGBASE-T Pair Swap and Polarity (Register 1.130)

IEEE Standard Register=1.130

PMA_MGBT_POLARITY

Reset Value

MULTIGBASE-T Pair Swap and Polarity (Register 1.130)

0003_H

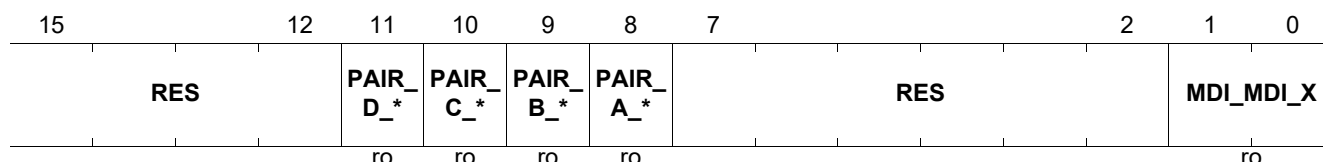

Field	Bits	Type	Description
PAIR_D_POLARITY	11	RO	Pair D Polarity 0 _B Polarity of pair D is not reversed. 1 _B Polarity of pair D is reversed.
PAIR_C_POLARITY	10	RO	Pair C Polarity 0 _B Polarity of pair C is not reversed. 1 _B Polarity of pair C is reversed.
PAIR_B_POLARITY	9	RO	Pair B Polarity 0 _B Polarity of pair B is not reversed. 1 _B Polarity of pair B is reversed.
PAIR_A_POLARITY	8	RO	Pair A Polarity 0 _B Polarity of pair A is not reversed. 1 _B Polarity of pair A is reversed.
MDI_MDI_X	1:0	RO	MDI/MDI-X Indicates the status of pair swaps at the MDI / MD-X. 00 _B ABCD CROSS Pair AB and Pair CD crossover 01 _B CD CROSS Pair CD crossover only 10 _B AB CROSS Pair AB crossover only 11 _B NORMAL No crossover

MULTIGBASE-T Tx Power Backoff and PHY Short Reach Setting (Register 1.131)

IEEE Standard Register=1.131

PMA_MGBT_TX_PBO

Reset Value

MULTIGBASE-T TX Power Backoff and PHY Short Reach Setting (Register 1.131)

0000_H

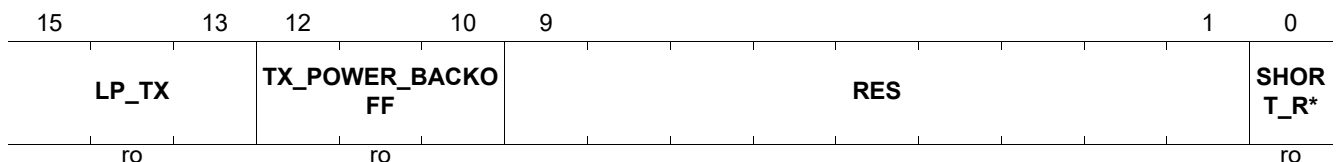

Field	Bits	Type	Description
LP_TX	15:13	RO	Link Partner Tx The power backoff setting of the link partner. The bit number assignment order is: 15 14 13 000 _B 0 dB 001 _B 2 dB 010 _B 4 dB 011 _B 6 dB 100 _B 8 dB 101 _B 10 dB 110 _B 12 dB 111 _B 14 dB
TX_POWER_BACKOFF	12:10	RO	Tx Power Backoff The power backoff of PHY211 PMA. The bit number assignment order is: 12 11 10 000 _B 0 dB 001 _B 2 dB 010 _B 4 dB 011 _B 6 dB 100 _B 8 dB 101 _B 10 dB 110 _B 12 dB 111 _B 14 dB
SHORT_REACH_MODE	0	RO	Short Reach Mode 0 _B PHY is not operating in short reach mode 1 _B PHY is operating in short reach mode (not supported)

MULTIGBASE-T Test Mode (Register 1.132)

IEEE Standard Register=1.132

PMA_MGBT_TEST_MODE

MULTIGBASE-T Test Mode (Register 1.132)

Reset Value

0000_H

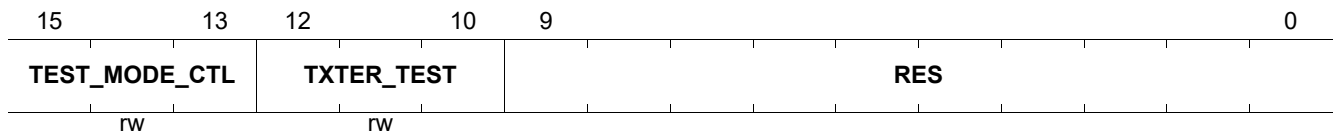

Field	Bits	Type	Description
TEST_MODE_CTL	15:13	RW	Test Mode Control 000 _B Normal operation 001 _B Test mode 1 010 _B Test mode 2 011 _B Test mode 3 100 _B Test mode 4 101 _B Test mode 5 110 _B Test mode 6 111 _B Test mode 7
TXTER_TEST	12:10	RW	Transmitter Test Frequencies for tones used in Test Mode 4. 000 _B Reserved 001 _B Dual tone 1 010 _B Dual tone 2 011 _B Reserved 100 _B Dual tone 3 101 _B Dual tone 4 110 _B Dual tone 5 111 _B Reserved

MULTIGBASE-T SNR Margin Channel A (Register 1.133)

Register 1.133 contains the current SNR operating margin measured at the slicer input for channel A for the MULTIGBASE-T PMA.

IEEE Standard Register=1.133

PMA_MGBT_SNR_OPMARGIN_A **Reset Value**
MULTIGBASE-T SNR Margin Channel A (Register 1.133) **0000_H**

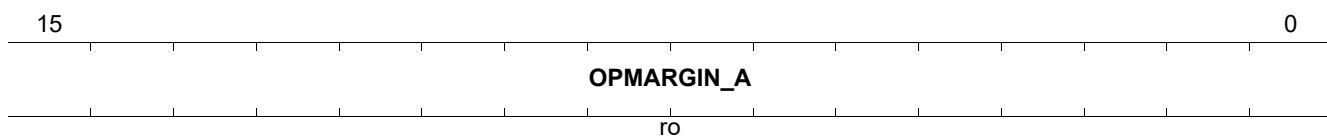

Field	Bits	Type	Description
OPMARGIN_A	15:0	RO	OPMARGIN_A SNR operating margin measured at the slicer input for channel A

MULTIGBASE-T SNR Margin Channel C (Register 1.135)

Register 1.135 contains the current SNR operating margin measured at the slicer input for channel C for the MULTIGBASE-T PMA.

IEEE Standard Register=1.135

PMA_MGBT_SNR_OPMARGIN_C **Reset Value**
MULTIGBASE-T SNR Margin Channel C (Register 1.135) **0000_H**

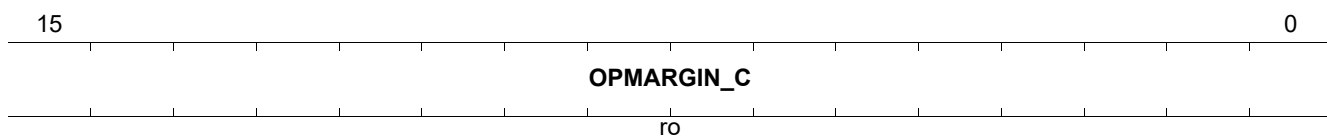

Field	Bits	Type	Description
OPMARGIN_C	15:0	RO	OPMARGIN_C SNR operating margin measured at the slicer input for channel C

MULTIGBASE-T SNR Margin Channel D (Register 1.136)

Register 1.136 contains the current SNR operating margin measured at the slicer input for channel D for the MULTIGBASE-T PMA.

IEEE Standard Register=1.136

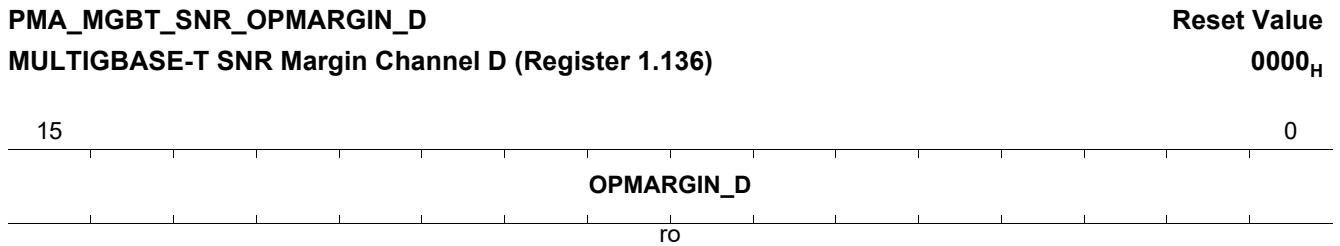

Field	Bits	Type	Description
OPMARGIN_D	15:0	RO	OPMARGIN_D SNR operating margin measured at the slicer input for channel D

MULTIGBASE-T SNR Minimum Margin Channel A (Register 1.137)

The minimum margin channel A register contains a latched copy of the lowest value observed in the SNR operating margin channel A register (1.133) since the last read.

IEEE Standard Register=1.137

PMA_MGBT_MINMARGIN_A	Reset Value
MULTIGBASE-T SNR Minimum Margin Channel A (Register 1.137)	0000_H

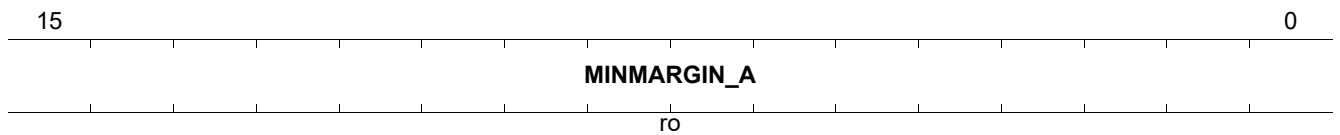

Field	Bits	Type	Description
MINMARGIN_A	15:0	RO	MINMARGIN_A Lowest value observed in the SNR operating margin channel A register (1.133) since the last read

MULTIGBASE-T SNR Minimum Margin Channel B (Register 1.138)

The minimum margin channel A register contains a latched copy of the lowest value observed in the SNR operating margin channel B register (1.134) since the last read.

IEEE Standard Register=1.138

PMA_MGBT_MINMARGIN_B

Reset Value

MULTIGBASE-T SNR Minimum Margin Channel B (Register 1.138)

0000_H

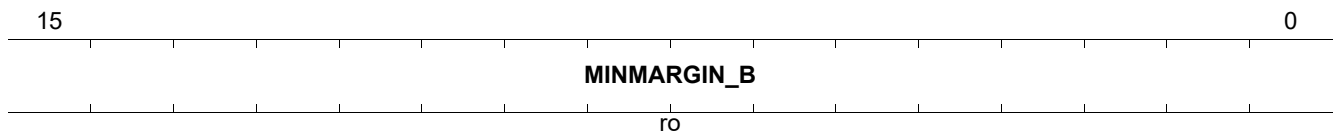

Field	Bits	Type	Description
MINMARGIN_B	15:0	RO	MINMARGIN_B Lowest value observed in the SNR operating margin channel B register (1.134) since the last read

MULTIGBASE-T SNR Minimum Margin Chan C (Register 1.139)

The minimum margin channel C register contains a latched copy of the lowest value observed in the SNR operating margin channel C register (1.135) since the last read.

IEEE Standard Register=1.139

PMA_MGBT_MINMARGIN_C

Reset Value

MULTIGBASE-T SNR Minimum Margin Chan C (Register 1.139)

0000_H

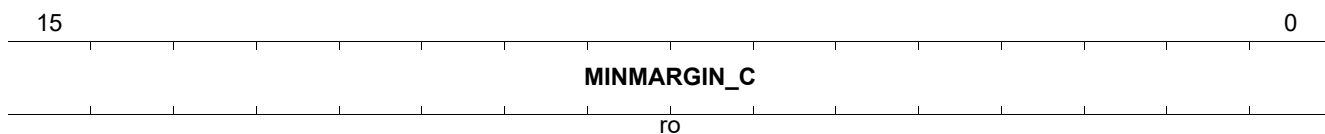

Field	Bits	Type	Description
MINMARGIN_C	15:0	RO	MINMARGIN_C Lowest value observed in the SNR operating margin channel C register (1.135) since the last read

MULTIGBASE-T SNR Minimum Margin Chan D (Register 1.140)

The Minimum margin channel D register contains a latched copy of the lowest value observed in the SNR operating margin channel D register (1.136) since the last read.

IEEE Standard Register=1.140

PMA_MGBT_MINMARGIN_D

Reset Value

MULTIGBASE-T SNR Minimum Margin Chan D (Register 1.140)

0000_H

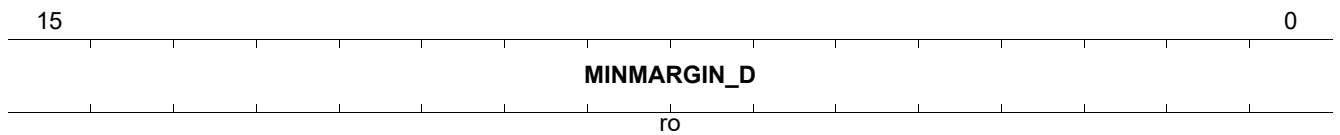

Field	Bits	Type	Description
MINMARGIN_D	15:0	RO	MINMARGIN_D Lowest value observed in the SNR operating margin channel D register (1.136) since the last read

MULTIGBASE-T Rx Power Channel A (Register 1.141)

The Rx signal power channel A register is read only and contains the receive signal power measured at the MDI during training as described in 55.4.3.1.

IEEE Standard Register=1.141

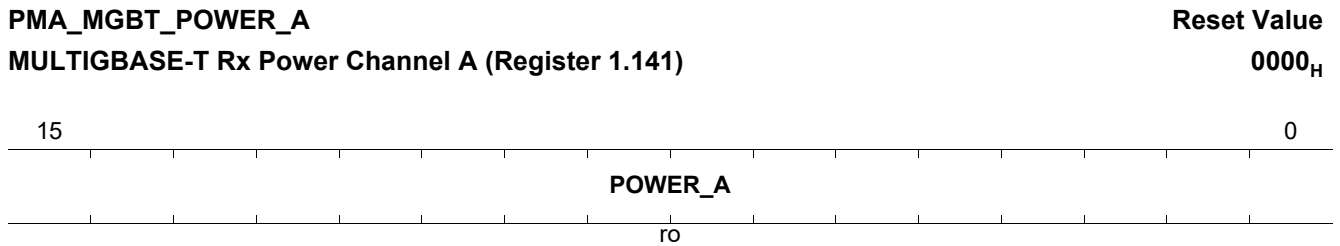

Field	Bits	Type	Description
POWER_A	15:0	RO	POWER_A Receive signal power measured at the MDI during training

MULTIGBASE-T Rx Power Channel B (Register 1.142)

The Rx signal power channel B register is read only and contains the receive signal power measured at the MDI during training as described in 55.4.3.1.

IEEE Standard Register=1.142

PMA_MGBT_POWER_B **Reset Value**
MULTIGBASE-T Rx Power Channel B (Register 1.142) **0000_H**

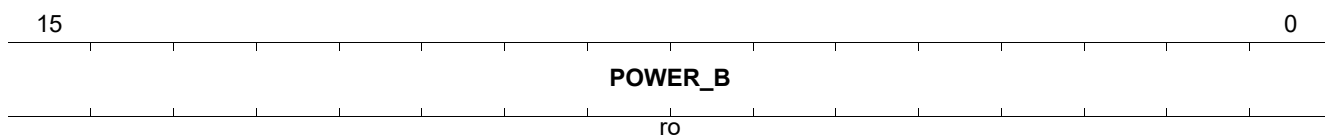

Field	Bits	Type	Description
POWER_B	15:0	RO	POWER_B Receive signal power measured at the MDI during training

MULTIGBASE-T Rx Power Chan C (Register 1.143)

The Rx signal power channel C register is read only and contains the receive signal power measured at the MDI during training as described in 55.4.3.1.

IEEE Standard Register=1.143

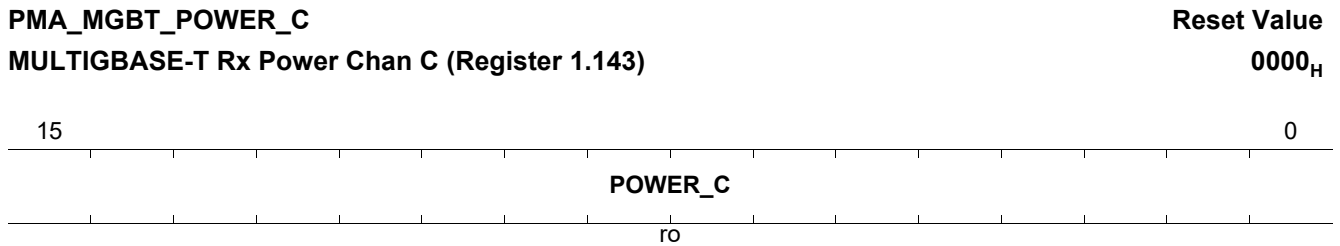

Field	Bits	Type	Description
POWER_C	15:0	RO	POWER_C Receive signal power measured at the MDI during training

MULTIGBASE-T Rx Power Chan D (Register 1.144)

The Rx signal power channel D register is read only and contains the receive signal power measured at the MDI during training as described in 55.4.3.1.

IEEE Standard Register=1.144

PMA_MGBT_POWER_D

Reset Value

MULTIGBASE-T Rx Power Chan D (Register 1.144)

0000_H

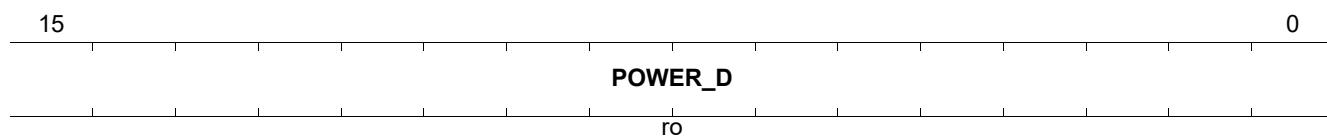

Field	Bits	Type	Description
POWER_D	15:0	RO	POWER_D Receive signal power measured at the MDI during training

MULTIGBASE-T Skew Delay 0 (Register 1.145)

IEEE Standard Register=1.145

The skew delay reports the current skew delay on each of the pairs with respect to physical pair A. It is reported with 1.25 ns resolution to an accuracy of 2.5 ns. The number is in two's complement notation with positive values representing delay and negative values representing advance with respect to physical pair A. When the delay exceeds the maximum amount represented by the range -80 ns to +78.75 ns, the field displays the maximum value.

PMA_MGBT_SKEW_DELAY_0

Reset Value

MULTIGBASE-T Skew Delay 0 (Register 1.145)

0000_H

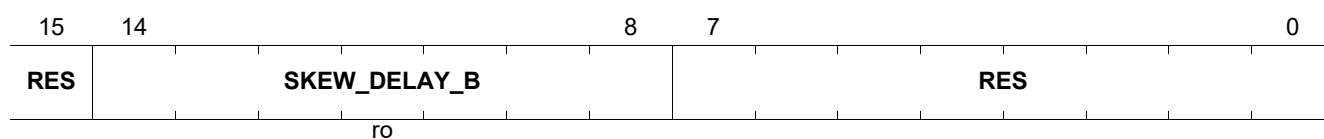

Field	Bits	Type	Description
SKEW_DELAY_B	14:8	RO	Skew Delay B Skew delay for pair B

MULTIGBASE-T Skew Delay 1 (Register 1.146)

IEEE Standard Register=1.146

The skew delay reports the current skew delay on each of the pairs with respect to physical pair A. It is reported with 1.25 ns resolution to an accuracy of 2.5 ns. The number is in two's complement notation with positive values representing delay and negative values representing advance with respect to physical pair A. When the delay exceeds the maximum amount represented by the range -80 ns to +78.75 ns, the field displays the maximum value.

PMA_MGBT_SKEW_DELAY_1

Reset Value

MULTIGBASE-T Skew Delay 1 (Register 1.146)

0000_H

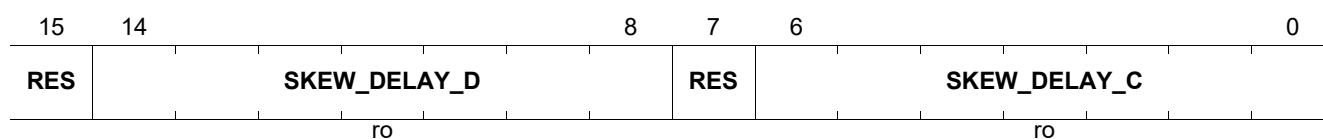

Field	Bits	Type	Description
SKEW_DELAY_D	14:8	RO	Skew Delay D Skew delay for pair D
SKEW_DELAY_C	6:0	RO	Skew Delay C Skew delay for pair C

MULTIGBASE-T Skew Delay 2 (Register 1.147)

IEEE Standard Register=1.147

PMA_MGBT_FAST_RETRAIN_STA_CTRL
MULTIGBASE-T Skew Delay 2 (Register 1.147)

Reset Value

0010_H



Field	Bits	Type	Description
LP_FAST_RETRAIN_COUNT	15:11	RO	LP Fast Retrain Count Counts the number of fast retrains requested by the link partner.
LD_FAST_RETRAIN_COUNT	10:6	RO	LD Fast Retrain Count Counts the number of fast retrains requested by the local device.
FAST_RETRAIN_ABILITY	4	RO	Fast Retrain Ability 0 _B Fast retrain capability is not supported. 1 _B Fast retrain capability is supported.
FAST_RETRAIN_NEGOTIATED	3	RO	Fast Retrain Negotiated 0 _B Fast retrain capability was not negotiated. 1 _B Fast retrain capability was negotiated.
FAST_RETRAIN_SIG_TYPE	2:1	RW	Fast Retrain Signal Type 00 _B PHY signals IDLE during fast retrain 01 _B PHY signals local fault during fast retrain 10 _B PHY signals link interruption during fast retrain 11 _B Reserved
FAST_RETRAIN_ENABLE	0	RW	Fast Retrain Enable 0 _B Fast retrain capability is disabled. 1 _B Fast retrain capability is enabled.

6.2 Standard PCS Registers

This section describes the PCS registers for MMD device 0x03.

Table 35 Registers Overview- Standard PCS Registers

Register Short Name	Register Long Name	Reset Value
PCS_CTRL1	PCS Control 1 (Register 3.0)	205C _H
PCS_STAT1	PCS Status 1 (Register 3.1)	0000 _H
PCS_DEVID1	PHY Identifier 1 (Register 3.2)	C133 _H
PCS_DEVID2	PHY Identifier 2 (Register 3.3)	5400 _H ¹⁾
PCS_SPEED_ABILITY	PCS Speed Ability (Register 3.4)	0040 _H
PCS_DIP1	PCS Devices in Package 1 (Register 3.5)	008B _H
PCS_DIP2	PCS Devices in Package 2 (Register 3.6)	C000 _H
PCS_CTRL2	PCS Control 2 (Register 3.7)	000A _H
PCS_STAT2	PCS Status 2 (Register 3.8)	9000 _H
PCS_PACKID1	PCS Package Identifier 1 (Register 3.14)	C133 _H
PCS_PACKID2	PCS Package Identifier 2 (Register 3.15)	5400 _H ¹⁾
PCS_EEE_CAP	PCS EEE Capability (Register 3.20)	0006 _H
PCS_EEE_CAP2	EEE Control and Capability 2 (Register 3.21)	0001 _H
PCS_EEE_WAKERR	PCS EEE Status Register 1 (Register 3.22)	0000 _H
PCS_2G5_STAT1	BASE-R and 10GBASE-T PCS Status 1 (Register 3.32)	0000 _H
PCS_2G5_STAT2	MULTIGBASE-T PCS Status 2 (Register 3.33)	0000 _H
PCS_TIMESYNC_CAP	PCS TimeSync Capability Register (Register 3.1800)	0000 _H

1) For the device specific reset value, see the Product and Package Naming table in the [Product Ordering Information](#) chapter.

6.2.1 PCS Register Descriptions

This section describes all the PCS registers in detail.

PCS Control 1 (Register 3.0)

IEEE Standard Register=3.0

PCS_CTRL1

PCS Control 1 (Register 3.0)

Reset Value

205C_H

15	14	13	12	11	10	9	7	6	5	2	1	0
RST	LOOPBACK	SSL	RES	LOW_POWER*	RXCKST	RES		SSM	SPEED_SEL		RES	
RW	RW	RW		RW	RW			RW		RW		

Field	Bits	Type	Description
RST	15	RW	Reset 0 _B Normal operation 1 _B PCS reset - Self-clearing
LOOPBACK	14	RW	Loopback 0 _B Disable loopback mode 1 _B Enable loopback mode
SSL	13	RW	Forced Speed Selection (LSB) This bit is used in conjunction with SPEED_SEL_LSB. The bit assignment order is: MSB LSB 00 _B 10 Mbps 01 _B 100 Mbps 10 _B 1000 Mbps 11 _B Bits [5:2] select the speed
LOW_POWER	11	RW	Low Power 0 _B Normal operation 1 _B Low-power mode
RXCKST	10	RW	Clock Stop Enable The MAC sets this bit to active to allow the GPHY to stop the clocking during the LPI_MODE. 0 _B The clock is not stoppable. 1 _B The GPHY stops the (X)GMII clock during LPI.
SSM	6	RW	Forced Speed Selection (MSB) This bit is used in conjunction with SPEED_SEL_MSB. The bit assignment order is: MSB LSB 00 _B 10 Mbps 01 _B 100 Mbps 10 _B 1000 Mbps 11 _B Bits [5:2] select the speed

Field	Bits	Type	Description (cont'd)
SPEED_SEL	5:2	RW	Forced Speed Selection Values 0 0 0 0 _B Unsupported, defaults to 2.5 Gbps 0 0 0 1 _B Unsupported, defaults to 2.5 Gbps 0 0 1 0 _B Unsupported, defaults to 2.5 Gbps 0 0 1 1 _B Unsupported, defaults to 2.5 Gbps 0 1 0 0 _B Unsupported, defaults to 2.5 Gbps 0 1 0 1 _B Reserved 0 1 1 1 _B 2.5 Gbps 1 1 x x _B Reserved

PHY Identifier 1 (Register 3.2)

IEEE Standard Register=3.2

PCS_DEVID1

PHY Identifier 1 (Register 3.2)

Reset Value

C133_H

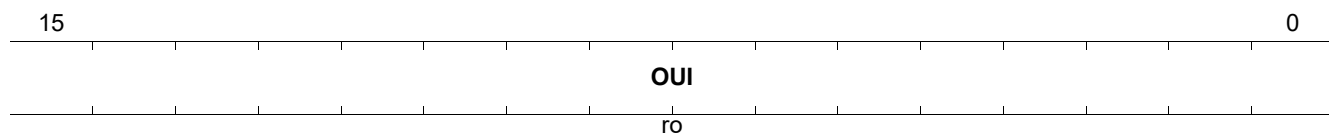

Field	Bits	Type	Description
OUI	15:0	RO	Organizationally Unique Identifier Bits 3:18

PCS Devices in Package 1 (Register 3.5)

IEEE Standard Register=3.5

PCS_DIP1

PCS Devices in Package 1 (Register 3.5)

Reset Value

008B_H

15	12	11	10	9	8	7	6	5	4	3	2	1	0
RES		SEPA RAT*	SEP_P MA*	SEPA RAT*	SEPA RAT*	ANEG	TC	DTE_X S	PHY_ XS	PCS	WIS_P RE*	PMD_ PMA	CL22
ro		ro	ro	ro	ro	ro	ro	ro	ro	ro	ro	ro	ro

Field	Bits	Type	Description
RES	15:12	RO	Reserved Ignore on read
SEPARATED_PMA_4	11	RO	Separate PMA (4) 0 _B Separate PMA (4) not present in package 1 _B Separate PMA (4) present in package
SEP_PMA_3	10	RO	Separate PMA (3) 0 _B Separate PMA (3) not present in package 1 _B Separate PMA (3) present in package
SEPARATED_PMA_2	9	RO	Separate PMA (2) 0 _B Separate PMA (2) not present in package 1 _B Separate PMA (2) present in package
SEPARATED_PMA_1	8	RO	Separate PMA (1) 0 _B Separate PMA (1) not present in package 1 _B Separate PMA (1) present in package
ANEG	7	RO	Auto-Negotiation Present 0 _B Auto-negotiation not present in package 1 _B Auto-negotiation present in package
TC	6	RO	TC Present 0 _B TC not present in package 1 _B TC present in package
DTE_XS	5	RO	DTE XS Present 0 _B DTE XS not present in package 1 _B DTE XS present in package
PHY_XS	4	RO	PHY XS Present 0 _B PHY XS not present in package 1 _B PHY XS present in package
PCS	3	RO	PCS Present 0 _B PCS not present in package 1 _B PCS present in package
WIS_PRESENT	2	RO	WIS Present 0 _B WIS not present in package 1 _B WIS present in package

Field	Bits	Type	Description (cont'd)
PMD_PMA	1	RO	PMD/PMA Present 0 _B PMA/PMD not present in package 1 _B PMA/PMD present in package
CL22	0	RO	Clause 22 Registers Present 0 _B Clause 22 registers not present in package 1 _B Clause 22 registers present in package

PCS Devices in Package 2 (Register 3.6)

IEEE Standard Register=3.6

PCS_DIP2

Reset Value

PCS Devices in Package 2 (Register 3.6)

C000_H

15	14	13	12								0
VEND OR_*	VEND OR_*	CLAU SE_*	RES								
ro	ro	ro	ro								

Field	Bits	Type	Description
VENDOR_SPECIFIC_DEVICE_2	15	RO	Vendor-specific Device 2 0 _B Vendor-specific device 2 not present in package 1 _B Vendor-specific device 2 present in package
VENDOR_SPECIFIC_DEVICE_1	14	RO	Vendor-specific Device 1 0 _B Vendor-specific device 1 not present in package 1 _B Vendor-specific device 1 present in package
CLAUSE_22_EXTENSION	13	RO	Clause 22 Extension 0 _B Clause 22 extension not present in package 1 _B Clause 22 extension present in package
RES	12:0	RO	Reserved Ignore on read.

PCS Status 2 (Register 3.8)

IEEE Standard Register=3.8

PCS_STAT2
PCS Status 2 (Register 3.8)
Reset Value
9000_H

15	14	13	12	11	10	9	6	5	4	3	2	1	0
DEVICE_PRESENT	RES	R2G5_CAPABLE*	TX_FAULT	RX_FAULT	RES			R10GBASE*	R40GBASE*	R10GBASE*	R10GBASE*	R10GBASE*	R10GBASE*
ro		ro	ro	ro				ro	ro	ro	ro	ro	ro

Field	Bits	Type	Description
DEVICE_PRESENT	15:14	RO	Device Present 00 _B No device responding at this address 01 _B No device responding at this address 10 _B Device responding at this address 11 _B No device responding at this address
R2G5_CAPABLE	12	RO	2G5BASE-T Capable 0 _B PCS is not able to support 2.5GBASE-T PCS type. 1 _B PCS is able to support 2.5GBASE-T PCS type.
TX_FAULT	11	RO	Transmit Fault 0 _B No fault condition on transmit path 1 _B Fault condition on transmit path
RX_FAULT	10	RO	Receive Fault 0 _B No fault condition on receive path 1 _B Fault condition on receive path
R10GBASE_R_CAPABLE	5	RO	100GBASE-R Capable 0 _B PCS is not able to support 100GBASE-R PCS type. 1 _B PCS is able to support 100GBASE-R PCS type.
R40GBASE_R_CAPABLE	4	RO	40GBASE-R Capable 0 _B PCS is not able to support 40GBASE-R PCS type. 1 _B PCS is able to support 40GBASE-R PCS type.
R10GBASE_T_CAPABLE	3	RO	10GBASE-T Capable 0 _B PCS is not able to support 10GBASE-T PCS type. 1 _B PCS is able to support 10GBASE-T PCS type.
R10GBASE_W_CAPABLE	2	RO	10GBASE-W Capable 0 _B PCS is not able to support 10GBASE-W PCS type. 1 _B PCS is able to support 10GBASE-W PCS type.
R10GBASE_X_CAPABLE	1	RO	10GBASE-X Capable 0 _B PCS is not able to support 10GBASE-X PCS type. 1 _B PCS is able to support 10GBASE-X PCS type.
R10GBASE_R_CAPABLE	0	RO	10GBASE-R Capable 0 _B PCS is not able to support 10GBASE-R PCS types. 1 _B PCS is able to support 10GBASE-R PCS types.

PCS Package Identifier 1 (Register 3.14)

IEEE Standard Register=3.14

PCS_PACKID1

Reset Value

PCS Package Identifier 1 (Register 3.14)

C133_H

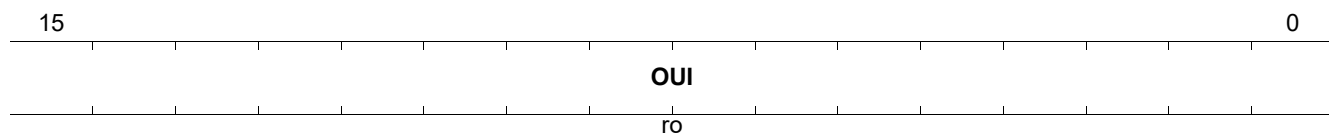

Field	Bits	Type	Description
OUI	15:0	RO	Organizationally Unique Identifier Bits 3:18

PCS Package Identifier 2 (Register 3.15)

IEEE Standard Register=3.15

PCS_PACKID2

PCS Package Identifier 2 (Register 3.15)

Reset Value

5400_H

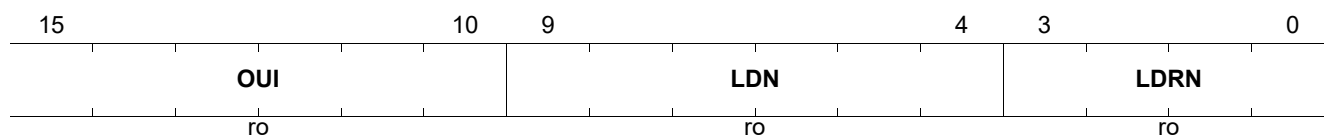

Field	Bits	Type	Description
OUI	15:10	RO	Organizationally Unique Identifier Bits 19:24
LDN	9:4	RO	Device Number Specifies the device number ¹⁾ to distinguish between several different products.
LDRN	3:0	RO	Device Revision Number Specifies the device revision number to distinguish between several versions of this device.

1) For the device specific reset value, see the Product and Package Naming table in the [Product Ordering Information](#) chapter.

PCS EEE Status Register 1 (Register 3.22)

IEEE Standard Register=3.22

PCS_EEE_WAKERR

PCS EEE Status Register 1 (Register 3.22)

Reset Value

0000_H

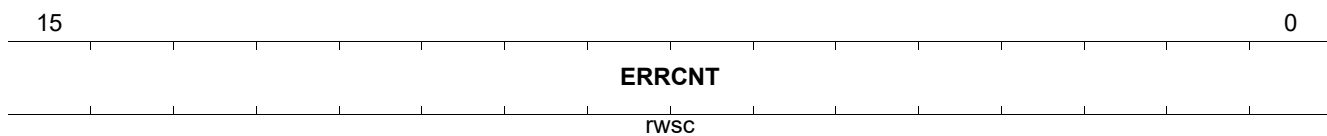

Field	Bits	Type	Description
ERRCNT	15:0	RWSC	EEE Wake Error Counter This is a 16-bit saturating counter indicating the number of times the GPHY PHY fails to wake up within the EEE time. This counter is cleared upon read from the STA.

BASE-R and 10GBASE-T PCS Status 1 (Register 3.32)

IEEE Standard Register=3.32

PCS_2G5_STAT1

Reset Value

BASE-R and 10GBASE-T PCS Status 1 (Register 3.32)

0000_H

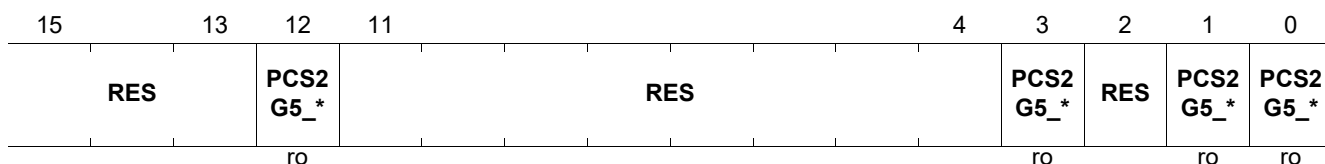

Field	Bits	Type	Description
PCS2G5_LINK_STATUS	12	RO	BASE-R and 10GBase-T Rx Link Status 0 _B 2G5 PCS receive link down 1 _B 2G5 PCS receive link up
PCS2G5_PAT_TEST_AB	3	RO	PRBS9 Pattern Testing Ability 0 _B PCS is not able to support PRBS9 pattern testing. 1 _B PCS is able to support PRBS9 pattern testing.
PCS2G5_HI_BER	1	RO	PCS 2G5 High BER This bit is a direct reflection of the state of the hi_lfer variable in 126.3.6.2.2 for 2.5GBASE-T. A latch high view of this status is reflected in MDIO register 3.33.14. 0 _B The 64B/65B receiver detects a BER below 10 ⁻⁴ . 1 _B The 64B/65B receiver detects a BER above or equal to 10 ⁻⁴ .
PCS2G5_BLOCK_LOCK	0	RO	PCS 2G5 Block Lock 0 _B 64B/65B receiver does not have block lock. 1 _B 64B/65B receiver has block lock.

MULTIGBASE-T PCS Status 2 (Register 3.33)

PCS_2G5_STAT2 Reset Value
MULTIGBASE-T PCS Status 2 (Register 3.33) 0000_H

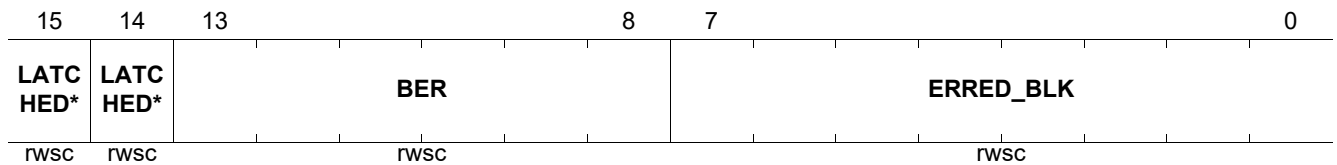

Field	Bits	Type	Description
LATCHED_BLOCK_LOCK	15	RWSC	Latched Block Lock 0 _B PCS 2G5 does not have block lock. 1 _B PCS 2G5 has block lock.
LATCHED_HIGH_BER	14	RWSC	Latched High BER 0 _B PCS 2G5 did not report a high BER. 1 _B PCS 2G5 reported a high BER.
BER	13:8	RWSC	BER BER counter
ERRORED_BLOCKS	7:0	RWSC	Errored Blocks Errored blocks counter

PCS TimeSync Capability Register (Register 3.1800)

IEEE Standard Register=3.1800

PCS_TIMESYNC_CAP

PCS TimeSync Capability Register (Register 3.1800)

Reset Value

0000_H



Field	Bits	Type	Description
TIMESYNC_TX_PATH_DATA_DELAY	1	RO	<p>TimeSync Transmit Path Data Delay</p> <p>0_B PCS does not provide information on transmit path data delay. For the GPHY, the value is always 0.</p> <p>1_B PCS provides information on transmit path data delay in registers 3.1801 through 3.1804.</p>
TIMESYNC_RX_PATH_DATA_DELAY	0	RO	<p>TimeSync Receive Path Data Delay</p> <p>0_B PCS does not provide information on receive path data delay. For the GPHY, the value is always 0.</p> <p>1_B PCS provides information on receive path data delay in registers 3.1805 through 3.1808.</p>

6.3 Standard Auto-Negotiation Registers for MMD=0x07

This register file contains the auto-negotiation registers for MMD device 0x07.

Table 36 Registers Overview- Standard Auto-Negotiation Registers

Register Short Name	Register Long Name	Reset Value
ANEG_CTRL	Auto-Negotiation Control (Register 7.0)	3000 _H
ANEG_STAT	Auto-Negotiation Status (Register 7.1)	0008 _H
ANEG_DEVID1	PHY Identifier 1 (Register 7.2)	C133 _H
ANEG_DEVID2	PHY Identifier 2 (Register 7.3)	5400 _H ¹⁾
ANEG_DIP1	Device in Package 1 (Register 7.5)	008B _H
ANEG_DIP2	Device in Package 2 (Register 7.6)	C000 _H
ANEG_PACKID1	AN Package Identifier (Register 7.14)	C133 _H
ANEG_PACKID2	AN Package Identifier (Register 7.15)	5400 _H ¹⁾
ANEG_ADV	ANEG Adv. for GPHY (Register 7.16)	9DE1 _H
ANEG_LP_BP_AB	AN Link Partner Base Page Ability (Register 7.19)	0DE0 _H
ANEG_XNP_TX1	ANEG Local Dev XNP TX1 (Register 7.22)	0001 _H
ANEG_XNP_TX2	ANEG Local Dev XNP TX2 (Register 7.23)	0000 _H
ANEG_XNP_TX3	ANEG Local Dev XNP TX3 (Register 7.24)	0000 _H
ANEG_LP_XNP_AB1	ANEG Link Partner XNP RX (Register 7.25)	0000 _H
ANEG_LP_XNP_AB2	ANEG Link Partner XNP RX (Register 7.26)	0000 _H
ANEG_LP_XNP_AB3	ANEG Link Partner XNP RX (Register 7.27)	0000 _H
ANEG_MGBT_AN_CTRL	MULTI GBT AN Control (Register 7.32)	0082 _H
ANEG_MGBT_AN_STA	MultiGBASE-T AN Status (Register 7.33)	0000 _H
ANEG_EEE_AN_ADV1	EEE Advertisement 1 (Register 7.60)	0006 _H
ANEG_EEE_AN_LPAB1	EEE Link Partner Ability 1 (Register 7.61)	0000 _H
ANEG_EEE_AN_ADV2	EEE Advertisement 2 (Register 7.62)	0001 _H
ANEG_EEE_LP_AB2	EEE Link Partner Ability 2 (Register 7.63)	0001 _H
ANEG_MGBT_AN_CTRL2	MGBT ANEG Control 2 (Register 7.64)	0008 _H

1) For the device specific reset value, see the Product and Package Naming table in the [Product Ordering Information](#) chapter.

6.3.1 ANEG Register Descriptions

This section describes all the ANEG registers in detail.

Auto-Negotiation Control (Register 7.0)

The register controls the main function of auto-negotiation as defined in Clause 45. Refer to IEEE 802.3 45.2.7.1. This register mirrors register STD_CTRL from Clause 22.

IEEE Standard Register=7.0

ANEG_CTRL

Reset Value

Auto-Negotiation Control (Register 7.0)

3000_H

15	14	13	12	11	10	9	8					0
RST	RES3	XNP	ANEG_EN*	RES2		ANEG_RE*	RES1					
RW	RO	RW	RW	RO		RW	RO					

Field	Bits	Type	Description
RST	15	RW	Reset This bit resets the entire PHY to its default state. Active links are terminated. This is a self-clearing bit. The GPHY firmware sets the bit to 0 via the hardware when the reset is completed. 0 _B NORMAL Normal GPHY operation 1 _B RESET GPHY reset
RES3	14	RO	Reserved Value always 0, writes ignored.
XNP	13	RW	Extended Next Page Control 0 _B ZERO Extended next page is disabled. 1 _B ONE Extended next page is enabled.
ANEG_ENAB	12	RW	Auto-Negotiation Enable This bit enables the ANEG process to determine the link configuration. Bit 7.0.12 is a copy of bit 0.12 in register 0 (STD_CTRL). 0 _B ZERO ANEG process is disabled. 1 _B ONE ANEG process is enabled.
RES2	11:10	RO	Reserved Value always zero, writes ignored.
ANEG_RESTART	9	RW	Restart Auto-Negotiation The ANEG process is restarted by setting bit 7.0.9 to 1. Bit 7.0.9 is a mirror of bit 0.9 in register 0 (STD_CTRL). Completion of ANEG is indicated in bit 0.1.5 and 7.1.5. 0 _B ZERO Normal operation 1 _B RESTART Restarts ANEG process.
RES1	8:0	RO	Reserved Value always 0, writes ignored.

Field	Bits	Type	Description (cont'd)
ANEG_RF	4	ROSC	<p>Remote Fault When read as 1, bit 7.1.4 indicates that a remote fault condition was detected. Bit 7.1.4 is a copy of bit 1.4 in register 1, device 0.</p> <p>0_B NORMAL No remote fault condition detected 1_B FAULT Remote fault condition detected</p>
ANEG_ABLE	3	RO	<p>Auto-Negotiation Ability Bit 7.1.3 is a copy of bit 1.3 in register 1. This is the ANEG ability of the GPHY.</p> <p>0_B UNABLE PHY is not able to perform ANEG. 1_B ABLE PHY is able to perform ANEG.</p>
LINKSTA	2	RO	<p>Link Status When read as 1_B, bit 7.1.2 indicates that the PMA/PMD determined that a valid link is established. This bit is a duplicate of the PMA/PMD link status bit in 1.1.2. This bit latches low so it does not represent the current status, but is used to indicate link drop since the last read from the management interface. Reading this bit from the MDIO resets the bit to the current value of the link.</p> <p>0_B DOWN Link is down. 1_B UP Link is up.</p>
RES1	1	RO	<p>Reserved Value always 0, write ignored.</p>
LP_ANEG_ABLE	0	RO	<p>Link Partner Auto-Negotiation Ability 0_B UNABLE Link partner is not capable of ANEG. 1_B ABLE Link partner is capable of ANEG.</p>

PHY Identifier 1 (Register 7.2)

ANEG_DEVID1

Reset Value

PHY Identifier 1 (Register 7.2)

C133_H

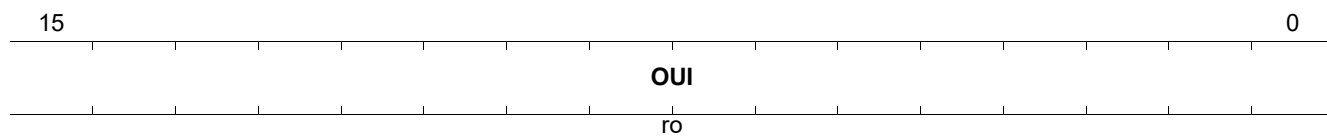

Field	Bits	Type	Description
OUI	15:0	RO	Organizationally Unique Identifier

PHY Identifier 2 (Register 7.3)

Organizationally Unique Identifier
IEEE Standard Register=7.3

ANEG_DEVID2

PHY Identifier 2 (Register 7.3)

Reset Value

5400_H

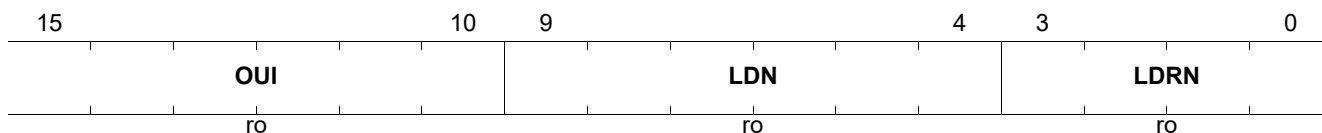

Field	Bits	Type	Description
OUI	15:10	RO	Organizationally Unique Identifier
LDN	9:4	RO	Device Number Specifies the device number ¹⁾ to distinguish between several different products.
LDRN	3:0	RO	Device Revision Number Specifies the device revision number ¹⁾ to distinguish between several versions of this device.

1) For the device specific reset value, see the Product and Package Naming table in the [Product Ordering Information](#) chapter.

Device in Package 1 (Register 7.5)

IEEE Standard Register=7.5

ANEG_DIP1

Device in Package 1 (Register 7.5)

Reset Value

008B_H

15	12	11	10	9	8	7	6	5	4	3	2	1	0
RES		PMA4	PMA3	PMA2	PMA1	ANEG	TC	DTEX S	PHYX S	PCS	WIS	PMAP MD	CL22
ro		ro	ro	ro	ro	ro	ro	ro	ro	ro	ro	ro	ro

Field	Bits	Type	Description
RES	15:12	RO	Reserved Ignore on read.
PMA4	11	RO	Separate PMA4 Present in Package 0 _B ABSENT Separate PMA4 not present in package 1 _B PRESENT Separate PMA4 present in package
PMA3	10	RO	Separate PMA3 Present in Package 0 _B ABSENT Separate PMA3 not present in package 1 _B PRESENT Separate PMA3 present in package
PMA2	9	RO	Separate PMA2 Present in Package 0 _B ABSENT Separate PMA2 not present in package 1 _B PRESENT Separate PMA2 present in package
PMA1	8	RO	Separate PMA1 Present in Package 0 _B ABSENT Separate PMA1 not present in package 1 _B PRESENT Separate PMA1 present in package
ANEG	7	RO	Auto-Negotiation Present in Package 0 _B ABSENT ANEG not present in package 1 _B PRESENT ANEG present in package
TC	6	RO	TC Present in Package 0 _B ABSENT TC registers not present in package 1 _B PRESENT TC registers present in package
DTEXS	5	RO	DTE XS Present in Package 0 _B ABSENT DTE XS registers not present in package 1 _B PRESENT DTE XS registers present in package
PHYXS	4	RO	PHYXS Present in Package 0 _B ABSENT PHYXS registers not present in package 1 _B PRESENT PHYXS registers present in package
PCS	3	RO	PCS Present in Package 0 _B ABSENT PCS registers not present in package 1 _B PRESENT PCS registers present in package
WIS	2	RO	WIS Present in Package 0 _B ABSENT WIS registers present in package 1 _B PRESENT WIS registers present in package

Field	Bits	Type	Description (cont'd)
PMAPMD	1	RO	PMA PMD Present in Package 0 _B ABSENT PMA PMD registers not present in package 1 _B PRESENT PMA PMD registers present in package
CL22	0	RO	Clause 22 Register Present in Package 0 _B ABSENT Clause 22 registers no present in package 1 _B PRESENT Clause 22 registers present in package

AN Package Identifier (Register 7.14)

IEEE Standard Register=7.14

ANEG_PACKID1

Reset Value

AN Package Identifier (Register 7.14)

C133_H

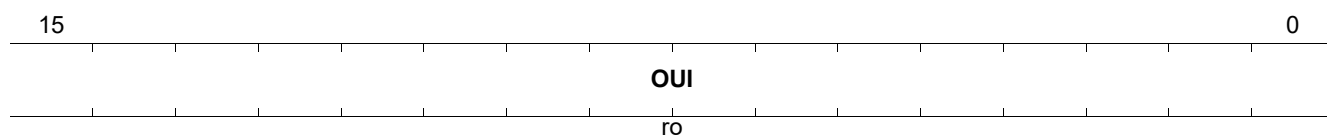

Field	Bits	Type	Description
OUI	15:0	RO	Organizationally Unique Identifier Bits 3:18

AN Package Identifier (Register 7.15)

IEEE Standard Register=7.15

ANEG_PACKID2

AN Package Identifier (Register 7.15)

Reset Value

5400_H

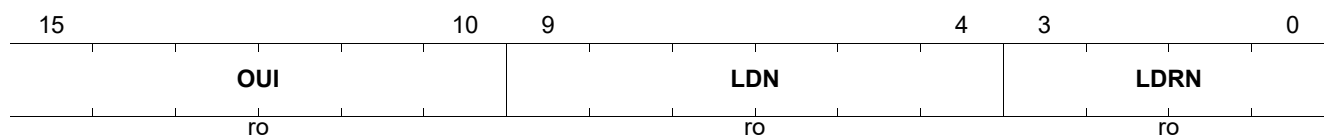

Field	Bits	Type	Description
OUI	15:10	RO	Organizationally Unique Identifier Bits 19:24
LDN	9:4	RO	Device Number Specifies the device number ¹⁾ to distinguish between several different products.
LDRN	3:0	RO	Device Revision Number Specifies the device revision number ¹⁾ to distinguish between several versions of this device.

1) For the device specific reset value, see the Product and Package Naming table in the [Product Ordering Information](#) chapter.

ANEG Adv. for GPHY (Register 7.16)

This register is a copy of the ANEG advertisement register (Register 4). A read to the AN advertisement register (7.16) reports the value of the ANEG advertisement register (Register 4). Writes to the AN advertisement register (7.16) cause a write to occur to the ANEG advertisement register (Register 4).

IEEE Standard Register=7.16

ANEG_ADV
Reset Value
ANEG Adv. for GPHY (Register 7.16)
9DE1_H

15	14	13	12	11				5	4				0
NP	RES	RF	XNP	TAF				SF					
RW	RO	RW	RW	RW				RW					

Field	Bits	Type	Description
NP	15	RW	Next Page Able 0 _B INACTIVE No next page allowed. 1 _B ACTIVE Additional next page(s) to follow.
RES	14	RO	Reserved Write as zero, ignore on read.
RF	13	RW	Remote Fault The remote fault bit allows indication of a fault to the link partner. Refer to IEEE 802.3 28.2.1.2.4.
XNP	12	RW	Transmission of Extended Next Pages Indicates that the GPHY is able to transmit extended next pages. 0 _B UNABLE GPHY is XNP unable. 1 _B ABLE GPHY is XNP able.
TAF	11:5	RW	Technology Ability Field The technology ability field is an 8-bit wide field containing information indicating supported technologies. The GPHY supports 10BASE-T (half- and full-duplex), 100BASE-TX (half- and full-duplex), and both symmetric and asymmetric PAUSE. 40 _H PS_ASYM Advertises asymmetric pause 20 _H PS_SYM Advertises symmetric pause 10 _H DBT4 Advertises 100BASE-T4 08 _H DBT_FDX Advertises 100BASE-TX full-duplex 04 _H DBT_HDX Advertises 100BASE-TX half-duplex 02 _H XBT_FDX Advertises 10BASE-T full-duplex 01 _H XBT_HDX Advertises 10BASE-T half-duplex
SF	4:0	RW	Selector Field This field is always set to 00001 _B because the GPHY only supports the 802.3 Ethernet standard. 00001 _B IEEE8023 IEEE 802.3 technology.

AN Link Partner Base Page Ability (Register 7.19)

Register 7.19 is a copy of register 5 from Clause 28. It contains the Base Page received from the link partner. All of the bits in the AN LP Base Page Ability register are read only.

IEEE Standard Register=7.19

ANEG_LP_BP_AB

Reset Value

AN Link Partner Base Page Ability (Register 7.19)

0DE0_H

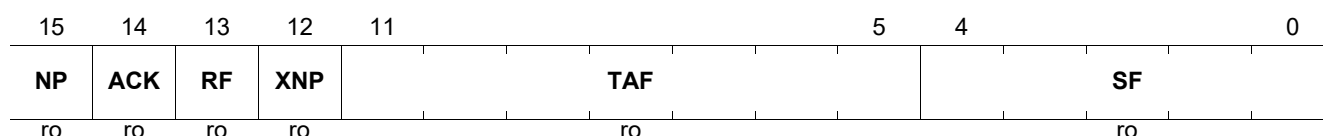

Field	Bits	Type	Description
NP	15	RO	Link Partner Next Page Next page request indication from the link partner. 0 _B INACTIVE No next page to follow 1 _B ACTIVE Additional next page to follow
ACK	14	RO	Link Partner Acknowledge Acknowledgment indication from the link partner's link code word. 0 _B INACTIVE Device did not successfully receive its link partner's link code word. 1 _B ACTIVE Device successfully received its link partner's link code word.
RF	13	RO	Link Partner Remote Fault Remote fault indication from the link partner. 0 _B NONE Remote fault is not indicated by the link partner. 1 _B FAULT Remote fault is indicated by the link partner.
XNP	12	RO	Link Partner XNP Ability 0 _B UNABLE Link partner is not XNP able. 1 _B ABLE Link partner is XNP able.
TAF	11:5	RO	Technology Ability Field These bits indicate the link partner's supported technologies received in the Base Page. 40 _H PS_ASYM Advertises asymmetric pause 20 _H PS_SYM Advertises symmetric pause 10 _H DBT4 Advertises 100BASE-T4 08 _H DBT_FDX Advertises 100BASE-TX full-duplex 04 _H DBT_HDX Advertises 100BASE-TX half-duplex 02 _H XBT_FDX Advertises 10BASE-T full-duplex 01 _H XBT_HDX Advertises 10BASE-T half-duplex

Field	Bits	Type	Description (cont'd)
SF	4:0	RO	<p>Link Partner Selector Field</p> <p>This selector field represents one of the 32 possible messages with encoding definitions defined in IEEE 802.3 Annex 28A.</p> <p>00_H Reserved</p> <p>01_H IEEE 802.3</p> <p>02_H IEEE 802.9 ISLAN-16T</p> <p>03_H IEEE 802.5</p> <p>04_H IEEE 1394</p> <p>05_H Reserved</p> <p>...</p> <p>1F_H Reserved</p>

ANEG Local Dev XNP TX1 (Register 7.22)

ANEG_XNP_TX1 Reset Value
ANEG Local Dev XNP TX1 (Register 7.22) 0001_H

	15	14	13	12	11	10											0
	NP	RES	MP	ACK2	TOGG		MCF										
	rw	ro	rw	rw	ro		rw										

Field	Bits	Type	Description
NP	15	RW	<p>Next Page When the NP bit is set, the GPHY requests to transmit one additional page. The next page transmission ends when both ends of a link segment set their next page bits to logic 0, indicating that neither has anything additional to transmit.</p> <p>0_B INACTIVE No next page to follow. 1_B ACTIVE Additional next page(s) to follow.</p>
RES	14	RO	<p>Reserved Write as 0, ignore on read.</p>
MP	13	RW	<p>Message Page Message Page (MP) is used by the next page function to differentiate a MP from an UP. Only MPs are used by the GPHY.</p> <p>0_B UNFOR Unformatted Page 1_B MESSG Message Page</p>
ACK2	12	RW	<p>Acknowledge 2 Not used during GPHY ANEG.</p> <p>0_B INACTIVE Device does not comply with message. 1_B ACTIVE Device complies with message.</p>
TOGG	11	RO	<p>Toggle The Toggle bit is used to ensure proper synchronization between the GPHY and the link partner.</p> <p>0_B ZERO Previous value of the Tx LCW was 1_B. 1_B ONE Previous value of the Tx LCW was 0_B.</p>

Field	Bits	Type	Description (cont'd)
MCF	10:0	RW	<p>Message Code Field</p> <p>When the Message Page bit is set to 1_B (7.16.1), this field is the Message Code Field of a message page used in a next page exchange. The message codes are described in IEEE 802.3 Appendix 28C. This is used to indicate the type of message in UCF1 and UCF2.</p> <p>00_H Reserved 01_H Null message 02_H One Unformatted Page (UP) with TAF follows 03_H Two UPs with TAF follows 04_H Remote fault details message 05_H OUI message 06_H PHY ID message 07_H 100BASE-T2 message 08_H 1000BASE-T message 09_H MULTIGBASE-T message 0A_H EEE technology capability follows in next UP 0B_H OUI XNP</p>

ANEG Local Dev XNP TX2 (Register 7.23)

Unformatted code field 1 contains seed information and advertises support of 1 GBT full-duplex and half-duplex. Refer to 28.2.3.4.

IEEE Standard Register=7.23

ANEG_XNP_TX2

Reset Value

ANEG Local Dev XNP TX2 (Register 7.23)

0000_H

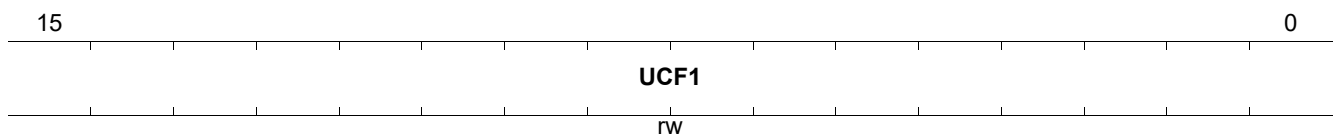

Field	Bits	Type	Description
UCF1	15:0	RW	Unformatted Code Field 1 Transmits the master-slave seed bit to facilitate ANEG resolution, port type, and duplex capability.

ANEG Local Dev XNP TX3 (Register 7.24)

Unformatted code field 2 - Register 7.24

Refer to 28.2.3.4.

IEEE Standard Register=7.24

ANEG_XNP_TX3

Reset Value

ANEG Local Dev XNP TX3 (Register 7.24)

0000_H

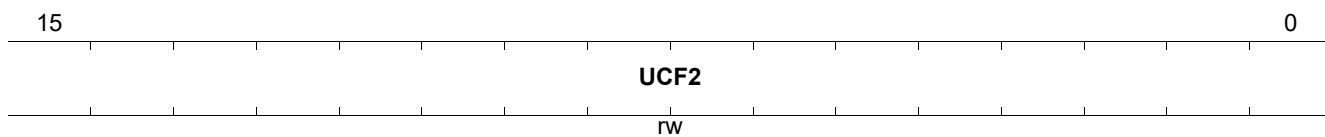

Field	Bits	Type	Description
UCF2	15:0	RW	Unformatted Code Field 2 2.5 GBASE-T ability is advertised by default.

ANEG Link Partner XNP RX (Register 7.26)

IEEE Standard Register=7.26

ANEG_LP_XNP_AB2

ANEG Link Partner XNP RX (Register 7.26)

Reset Value

0000_H

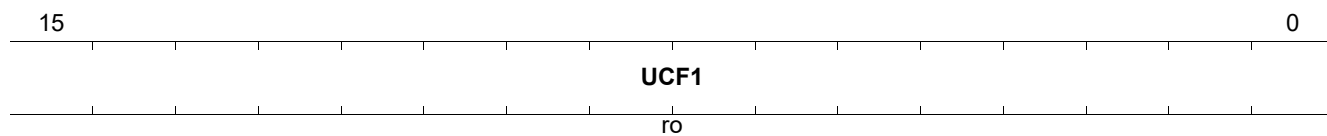

Field	Bits	Type	Description
UCF1	15:0	RO	Unformatted Code Field 1 Refer to 28.2.3.4.

ANEG Link Partner XNP RX (Register 7.27)

IEEE Standard Register=7.27

ANEG_LP_XNP_AB3

ANEG Link Partner XNP RX (Register 7.27)

Reset Value

0000_H

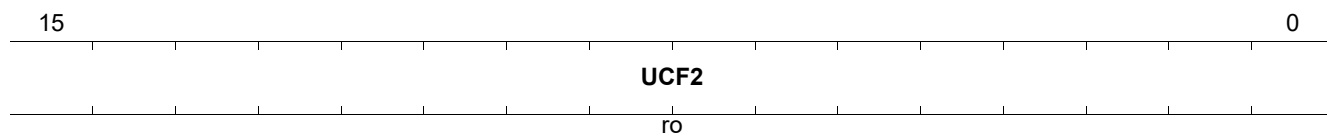

Field	Bits	Type	Description
UCF2	15:0	RO	Unformatted Code Field 2 Refer to 28.2.3.4.

MULTI GBT AN Control Register (Register 7.32)

This register advertises the GPHY capabilities.

IEEE Standard Register=7.32

ANEG_MGBT_AN_CTRL
Reset Value
MULTI GBT AN Control Register (Register 7.32)
0082_H

15	14	13	12	11		9	8	7	6	5	4	3	2	1	0
MS_M AN_*	MSCV	PT	AB_10 GBT		RES2		AB_5 GBT	AB_2 G5BT	FR_5G BT	FR_2G 5BT		RES1	LDPM A	FR	LDL
rw	rw	rw	ro		ro		ro	rw	ro	rw		ro	rw	rw	rw

Field	Bits	Type	Description
MS_MAN_EN	15	RW	Master Slave Manual Config Enable 0 _B ANEG ANEG is used to determine the master-slave selection. 1 _B MAN Manual configuration. The MSCV bit determines the master-slave selection.
MSCV	14	RW	Master Slave Config Value 0 _B SLAVE Manual set to SLAVE 1 _B MASTER Manual set to MASTER
PT	13	RW	Port Type 0 _B MASTER Preference as Master - single port device 1 _B SLAVE Preference as Slave - multi-port device
AB_10GBT	12	RO	10GBASE-T Ability Not supported. Value always 0.
RES2	11:9	RO	Reserved Value always 0, writes ignored.
AB_5GBT	8	RO	5GBASE-T Ability Not supported by the GPHY. 0 _B UNABLE Do not advertise PHY as 5GBASE-T capable. 1 _B ABLE Advertises PHY as 5GBASE-T capable. Not supported.
AB_2G5BT	7	RW	2.5GBASE-T Ability 0 _B UNABLE Do not advertise PHY as 2.5GBASE-T capable. 1 _B ABLE Advertises PHY as 2.5GBASE-T capable.
FR_5GBT	6	RO	5GBASE-T Fast Retrain Ability Not supported by GPHY. 0 _B UNABLE Do not advertise PHY as 5GBASE-T fast retrain able. 1 _B ABLE Advertises PHY as 5GBASE-T fast retrain capable. Not supported.
FR_2G5BT	5	RW	2.5GBASE-T Fast Retrain Ability 0 _B UNABLE Do not advertise PHY as 2.5G fast retrain able. 1 _B ABLE Advertises PHY as 2.5G fast retrain able.
RES1	4:3	RO	Reserved Value always 0, writes ignored.

Field	Bits	Type	Description (cont'd)
LDPMA	2	RW	<p>GPHY PMA Training Reset Request</p> <p>When this bit is set to 1_B, the GPHY expects the link partner to reset the PMA training PRBS for every PMA training frame.</p> <p>When this bit is set to 0_B, the GPHY expects the link partner to run the PMA training PRBS continuously through every PMA training frame.</p>
FR	1	RW	Fast Retrain Ability
LDL	0	RW	GPHY Loop Timing Ability

MultiGBASE-T AN Status Register (Register 7.33)

IEEE Standard Register=7.33

ANEG_MGBT_AN_STA

MultiGBASE-T AN Status register (Register 7.33)

Reset Value

0000_H

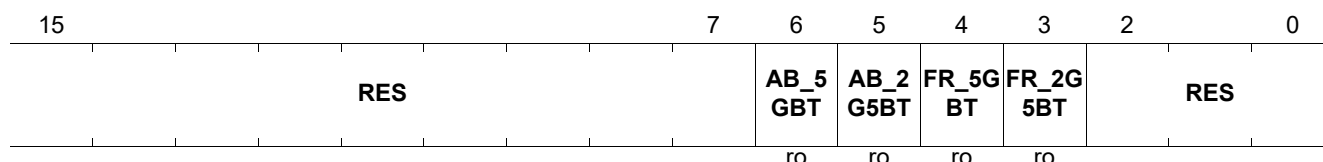

Field	Bits	Type	Description
AB_5GBT	6	RO	5GBASE-T Ability of Link Partner This bit is only valid when the link is established and ANEG completed. 0 _B UNABLE Link partner is not capable of 5GBASE-T. 1 _B ABLE Link partner is capable of 5GBASE-T.
AB_2G5BT	5	RO	2.5GBASE-T Ability of Link Partner This bit is only valid when the link is established and ANEG completed (bit 7.1.5 is set to 1 _B). 0 _B UNABLE Link partner is not capable of 2.5GBASE-T. 1 _B ABLE Link partner is capable of 2.5GBASE-T.
FR_5GBT	4	RO	5GBASE-T Fast Retrain Ability of Link Partner This bit is only valid when the link is established and ANEG completed. 0 _B UNABLE Link partner is not capable of 5GBASE-T fast retrain. 1 _B ABLE Link partner is capable of 5GBASE-T fast retrain
FR_2G5BT	3	RO	2.5GBASE-T Fast Retrain Ability of Link Partner This bit is only valid when the link is established and ANEG completed (bit 7.1.5 is set to 1 _B). 0 _B UNABLE Link partner is not capable of 2.5GBASE-T fast retrain. 1 _B ABLE Link partner is capable of 2.5GBASE-T fast retrain.

EEE Advertisement 2 (Register 7.62)

EEE advertisement 2 register is a continuation of EEE advertisement 1 register.

IEEE Standard Register=7.62

ANEG_EEE_AN_ADV2

Reset Value

EEE Advertisement 2 (Register 7.62)

0001_H

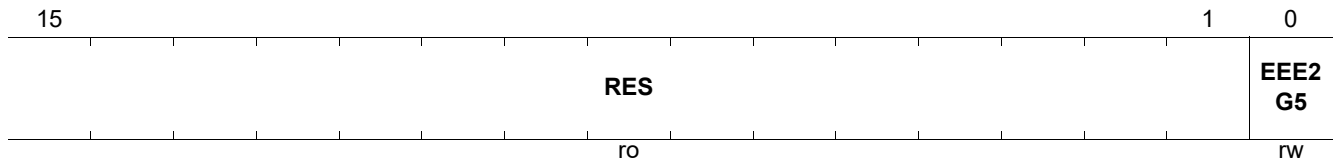

Field	Bits	Type	Description
RES	15:1	RO	Reserved
EEE2G5	0	RW	Advertise 2.5GBASE-T EEE Capability 0 _B DISABLED This PHY mode does not advertise 2.5GBASE-T EEE. 1 _B ENABLE This PHY mode advertises 2.5GBASE-T EEE.

EEE Link Partner Ability 2 (Register 7.63)

When the AN and training processes are complete, this register reflects the contents of the link partner's EEE advertisement 2 register.

IEEE Standard Register=7.63

All the bits in the EEE LP Ability 2 register are read-only. A write to the EEE LP Ability 2 register has no effect.

ANEG_EEE_LP_AB2

Reset Value

EEE Link Partner Ability 2 (Register 7.63)

0001_H

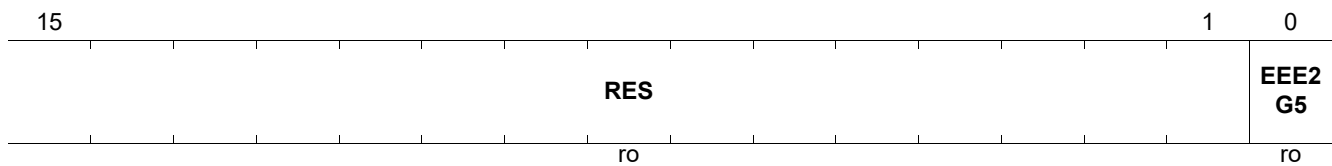

Field	Bits	Type	Description
RES	15:1	RO	Reserved
EEE2G5	0	RO	Link Partner Advertised 2.5GBASE-T EEE Capability 0 _B DISABLED LP is not 2.5GBASE-T EEE capable. 1 _B ENABLE LP is 2.5GBASE-T EEE capable.

MGBT ANEG Control 2 (Register 7.64)

This register is an extension of the ANEG Control Register for Multi GBT. It is used for 2.5 G ANEG configuration. IEEE Standard Register=7.64

Bit 7.64.3 is valid only when 7.32.5 is set to 1_B advertising fast retrain ability, and is used to request the link partner whether to initially reset the THP during fast retrain. THP Bypass Request is exchanged during link training, refer to 126.4.2.5.10.

When bit 7.64.3 is set to 0_B, the GPHY requests the link partner not to reset THP during fast retrain.

When bit 7.64.3 is set to 1_B, the GPHY requests the link partner to initially reset THP during fast retrain.

ANEG_MGBT_AN_CTRL2

Reset Value

MGBT ANEG Control 2 (Register 7.64)

0008_H

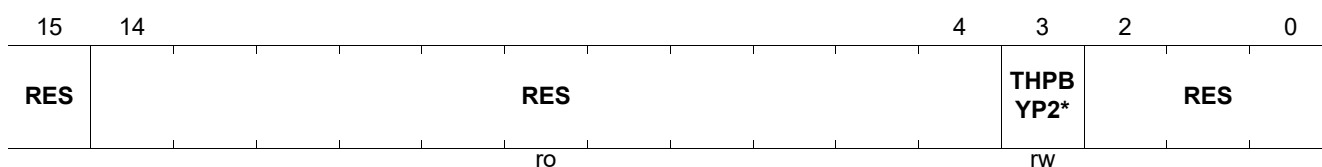

Field	Bits	Type	Description
RES	14:4	RO	Reserved
THPBYP2G5	3	RW	THP Bypass During Fast Retrain The GPHY requests a THP bypass during fast retrain. 0 _B NORST GPHY requests the link partner NOT to initially reset THP during fast retrain. 1 _B RST GPHY requests the link partner to initially reset THP during fast retrain.

6.4 Vendor Specific 1 Device Registers

This register file contains GPHY-specific registers for MMD=30 (decimal).

Table 37 Registers Overview- Vendor Specific 1 Device Registers

Register Short Name	Register Long Name	Reset Value
VSPEC1_LED0	Configuration for LED Pin 0 (Register 30.1)	0310 _H
VSPEC1_LED1	Configuration for LED Pin 1 (Register 30.2)	0320 _H
VSPEC1_LED2	Configuration for LED Pin 2 (Register 30.3)	0340 _H
VSPEC1_TXS_SCL_OFFSET	PHY Transmit Amplitude Control Register (Register 30.8)	0000 _H
VSPEC1_NBT_DS_CTRL	NBASE-T Downshift Control Register (Register 30.10)	0400 _H
VSPEC1_NBT_DS_STA	NBASE-T Downshift Status Register (Register 30.11)	0000 _H
VSPEC1_PM_CTRL	Packet Manager Control (Register 30.12)	3000 _H
VSPEC1_TEMP_STA	Temperature Code (Register 30.14)	0000 _H
VSPEC1_IMASK	VSPEC1 Interrupt Mask Register (Register 30.17)	0000 _H
VSPEC1_ISTAT	VSPEC1 Interrupt Mask Register (Register 30.18)	0000 _H
VSPEC1_USXGMII_STAT	USXGMII Status Register (Register 30.19)	0000 _H
VSPEC1_LANE_ASP_MAP	ASP Mapping to Physical Lanes (Register 30.20)	00E4 _H
VSPEC1_LOW_POWER_ENTRY_TIME	Time to Enter Low Power (Register 30.21)	0001 _H
VSPEC1_FRCTL	Fast Retrain Control and Status (Register 30.22)	0000 _H

6.4.1 VSPEC1 Register Descriptions

This section describes all the VSPEC1 registers in detail.

Configuration for LED Pin 0 (Register 30.1)

This register configures the behavior of the LED0 pin depending on predefined states or events the PHY entered into or raised. Since more than one event/state may be active at the same time, more than one function may apply at the same time. The priority from highest to lowest is given by the order: PULSE, BLINKS, BLINKF, and CON. The LED PULSE for the selected activity is only displayed for the link speed selected in CON. When CON is selected as NONE, no PULSE is displayed on the LED for any activity. To avoid the LED being constantly on when it is configured for pulsing alone, set the NO_CON bit in the PULSE field (bit 11).

IEEE Standard Register=30.1

VSPEC1_LED0

Reset Value

Configuration for LED Pin 0 (Register 30.1)

0310_H

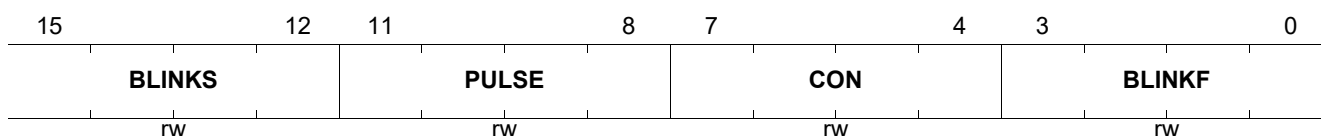

Field	Bits	Type	Description
BLINKS	15:12	RW	<p>Slow Blinking Configuration</p> <p>The BLINKS field selects the PHY states where the LED blinks with the predefined slow frequency. Each bit mask indicates a link speed. Combinations of these bit masks are used to provide a combination of link speed states to enable the behavior.</p> <p>0000_BNONE Not active 0001_BLINK10 Blink when link is 10 Mbps. 0010_BLINK100 Blink when link is 100 Mbps. 0100_BLINK1000 Blink when link is 1000 Mbps. 1000_BLINK2500 Blink when link is 2500 Mbps.</p>
PULSE	11:8	RW	<p>Pulsing Configuration</p> <p>The PULSE field is a mask field that combines certain events, such as TXACT RXACT, to generate a pulse on the LED when such an event is detected.</p> <p>0000_BNONE No pulsing 0001_BTXACT Transmit activity 0010_BRXACT Receive activity 0100_BCOL Collision 1000_BNO_CON Constant on behavior is switched off.</p>

Field	Bits	Type	Description (cont'd)
CON	7:4	RW	<p>Constant On Configuration</p> <p>The CON field selects the PHY states where the LED is constantly on. Each bit mask indicates a link speed. Combinations of these bit masks are used to provide a combination of link speed states to enable the behavior.</p> <p>0000_BNONE Not active 0001_BLINK10 On when link is 10 Mbps. 0010_BLINK100 On when link is 100 Mbps. 0100_BLINK1000 On when link is 1000 Mbps. 1000_BLINK2500 On when link is 2500 Mbps.</p>
BLINKF	3:0	RW	<p>Fast Blinking Configuration</p> <p>The BLINKF field selects the PHY states where the LED blinks with the predefined fast frequency. Each bit mask indicates a link speed. Combinations of these bit masks are used to provide a combination of link speed states to enable the behavior.</p> <p>0000_BNONE No active 0001_BLINK10 Blink when Link is 10 Mbps. 0010_BLINK100 Blink when Link is 100 Mbps. 0100_BLINK1000 Blink when Link is 1000 Mbps. 1000_BLINK2500 Blink when Link is 2500 Mbps.</p>

Configuration for LED Pin 1 (Register 30.2)

Configuration register for LED pin 1

IEEE Standard Register=30.2

VSPEC1_LED1

Configuration for LED Pin 1 (Register 30.2)

Reset Value

0320_H

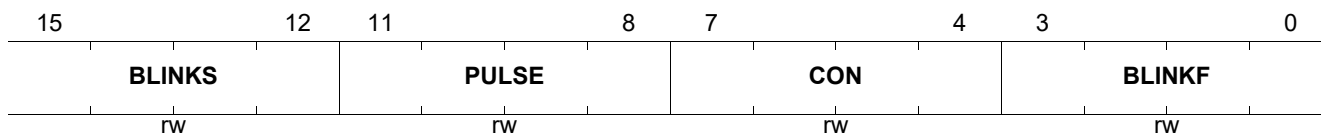

Field	Bits	Type	Description
BLINKS	15:12	RW	<p>Slow Blinking Configuration</p> <p>The BLINKS field selects the PHY states where the LED blinks with the predefined slow frequency. Each bit mask indicates a link speed. Combinations of these bit masks are used to provide a combination of link speed states to enable the behavior.</p> <p>0000_BNONE Not active 0001_BLINK10 Blink when link is 10 Mbps. 0010_BLINK100 Blink when link is 100 Mbps. 0100_BLINK1000 Blink when link is 1000 Mbps. 1000_BLINK2500 Blink when link is 2500 Mbps.</p>
PULSE	11:8	RW	<p>Pulsing Configuration</p> <p>The PULSE field is a mask field that combines certain events, such as TXACT RXACT, to generate a pulse on the LED when such an event is detected.</p> <p>0000_BNONE No pulsing 0001_BTXACT Transmit activity 0010_BRXACT Receive activity 0100_BCOL Collision 1000_BNO_CON Constant on behavior is switched off.</p>
CON	7:4	RW	<p>Constant On Configuration</p> <p>The CON field selects the PHY states where the LED is constantly on. Each bit mask indicates a link speed. Combinations of these bit masks are used to provide a combination of link speed states to enable the behavior.</p> <p>0000_BNONE Not active 0001_BLINK10 On when link is 10 Mbps. 0010_BLINK100 On when link is 100 Mbps. 0100_BLINK1000 On when link is 1000 Mbps. 1000_BLINK2500 On when link is 2500 Mbps.</p>

Field	Bits	Type	Description (cont'd)
BLINKF	3:0	RW	<p>Fast Blinking Configuration</p> <p>The BLINKF field selects the PHY states where the LED blinks with the predefined fast frequency. Each bit mask indicates a link speed. Combinations of these bit masks are used to provide a combination of link speed states to enable the behavior.</p> <p>0000_BNONE Not active 0001_BLINK10 Blink when link is 10 Mbps. 0010_BLINK100 Blink when link is 100 Mbps. 0100_BLINK1000 Blink when link is 1000 Mbps. 1000_BLINK2500 Blink when link is 2500 Mbps.</p>

Configuration for LED Pin 2 (Register 30.3)

Configuration register for LED pin 2

IEEE Standard Register=30.3

VSPEC1_LED2

Reset Value

Configuration for LED Pin 2 (Register 30.3)

0340_H

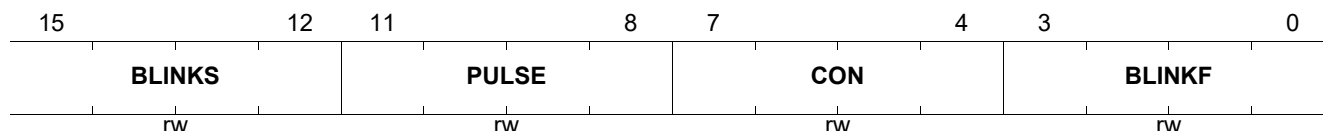

Field	Bits	Type	Description
BLINKS	15:12	RW	<p>Slow Blinking Configuration</p> <p>The BLINKS field selects the PHY states where the LED blinks with the predefined slow frequency. Each bit mask indicates a link speed. Combinations of these bit masks are used to provide a combination of link speed states to enable the behavior.</p> <p>0000_BNONE Not active 0001_BLINK10 Blink when link is 10 Mbps. 0010_BLINK100 Blink when link is 100 Mbps. 0100_BLINK1000 Blink when link is 1000 Mbps. 1000_BLINK2500 Blink when link is 2500 Mbps.</p>
PULSE	11:8	RW	<p>Pulsing Configuration</p> <p>The PULSE field is a mask field that combines certain events, such as TXACT RXACT, to generate a pulse on the LED when such an event is detected.</p> <p>0000_BNONE No pulsing 0001_BTXACT Transmit activity 0010_BRXACT Receive activity 0100_BCOL Collision 1000_BNO_CON Constant on behavior is switched off.</p>
CON	7:4	RW	<p>Constant On Configuration</p> <p>The CON field selects the PHY states where the LED is constantly on. Each bit mask indicates a link speed. Combinations of these bit masks are used to provide a combination of link speed states to enable the behavior.</p> <p>0000_BNONE Not active 0001_BLINK10 On when link is 10 Mbps. 0010_BLINK100 On when link is 100 Mbps. 0100_BLINK1000 On when link is 1000 Mbps. 1000_BLINK2500 On when link is 2500 Mbps.</p>

Field	Bits	Type	Description (cont'd)
BLINKF	3:0	RW	<p>Fast Blinking Configuration</p> <p>The BLINKF field selects the PHY states where the LED blinks with the predefined fast frequency. Each bit mask indicates a link speed. Combinations of these bit masks are used to provide a combination of link speed states to enable the behavior.</p> <p>0000_BNONE Not Active</p> <p>0001_BLINK10 Blink when link is 10 Mbps.</p> <p>0010_BLINK100 Blink when link is 100 Mbps.</p> <p>0100_BLINK1000 Blink when link is 1000 Mbps.</p> <p>1000_BLINK2500 Blink when link is 2500 Mbps.</p>

PHY Transmit Amplitude Control Register (Register 30.8)

This register adjusts the transmit amplitude of the PHY.

IEEE Standard Register=30.8

VSPEC1_TXS_SCL_OFFSET

Reset Value

PHY Transmit Amplitude Control Register (Register 30.8)

0000_H

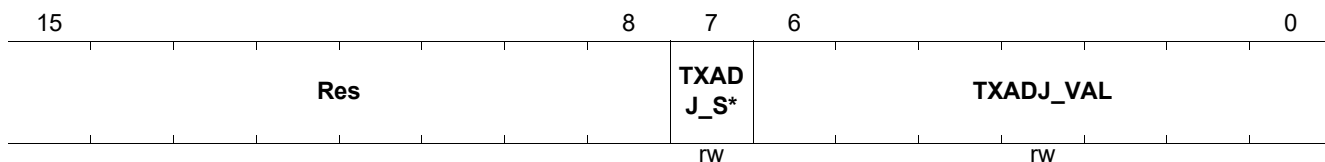

Field	Bits	Type	Description
TXADJ_SGN	7	RW	Transmit Amplitude Adjustment Sign 0 _B INC Increase transmit amplitude 1 _B DEC Decrease transmit amplitude
TXADJ_VAL	6:0	RW	Transmit Amplitude Adjustment Value Multiply the transmit amplitude by the following factor. (1 + (1-TXADJ_SGN*2)*TXADJ_VAL/128) The amplitude adjustment takes effect on the next link up.

NBASE-T Downshift Control Register (Register 30.10)

IEEE Standard Register=30.10

VSPEC1_NBT_DS_CTRL

Reset Value

NBASE-T Downshift Control Register (Register 30.10)

0400_H

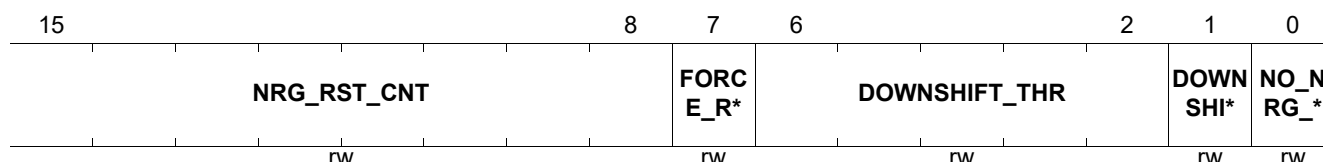

Field	Bits	Type	Description
NRG_RST_CNT	15:8	RW	Timer to Reset the Downshift Process When the energy is zero for a duration equal to NRG_RST_CNT seconds, the ANEG advertised capabilities are reset to the maximum GPHY capabilities. When NRG_RST_CNT is lower than 2, the ADS feature cannot be enabled. Default is 4 seconds. <i>Note: This timer only takes effect when NO_NRG_RST is set.</i>
FORCE_RST	7	RW	Force Reset of Downshift Process Setting this bit to 1 immediately resets the ANEG advertised capabilities to the maximum GPHY capabilities.
DOWNSHIFT_THR	6:2	RW	NBASE-T Downshift Training Counter Threshold dsh_thr variable in NBASE-T specification This is a 4-bit counter from 0 to 15 used to control the number of training cycles allowed for linkup, otherwise downshift.
DOWNSHIFT_EN	1	RW	NBASE-T Downshift Enable dsh_en variable in NBASE-T specification 0 _B DISABLE Disables NBT downshift. 1 _B ENABLE Enables NBT downshift.
NO_NRG_RST	0	RW	Advertise All Speeds if No Energy Detected When no energy is detected, this resets to advertise all speeds. Energy variable in NBASE-T specification 0 _B DISABLE Do not reset speeds advertised when no energy is detected. 1 _B ENABLE Reset speeds advertised when no energy is detected.

NBASE-T Downshift Status Register (Register 30.11)

IEEE Standard Register=30.11

VSPEC1_NBT_DS_STA

Reset Value

NBASE-T Downshift Status Register (Register 30.11)

0000_H

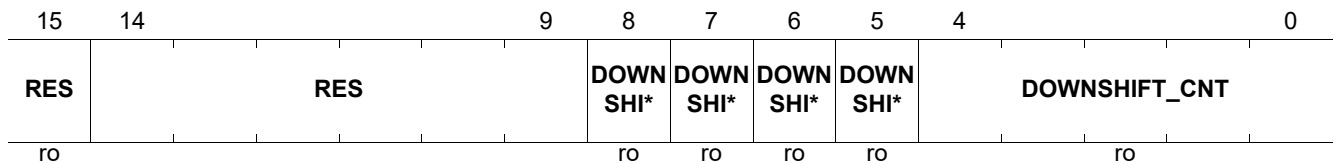

Field	Bits	Type	Description
DOWNSHIFT_1G	8	RO	Downshift from 1G to Lower Speed
DOWNSHIFT_2G5	7	RO	Downshift from 2.5 G to Lower Speed
DOWNSHIFT_5G	6	RO	Downshift 5G to Lower Speed Not supported by the GPHY
DOWNSHIFT_10G	5	RO	Downshift 10G to Lower Speed Not supported by the GPHY
DOWNSHIFT_CNT	4:0	RO	Training Attempt Counter Counts training attempts to select the operating speed. dsh_cnt state variable in NBASE-T specification

Packet Manager Control (Register 30.12)

IEEE Standard Register=30.12

Control the Packet Manager Configuration

VSPEC1_PM_CTRL

Reset Value

Packet Manager Control (Register 30.12)

3000_H

15	14	13	12	11	10	9	8	7	6	5	4	3	2	1	0
RES	USXGMII_REACH		MDINT_M*	RES	RES	RES	RES	RES	RES	RES	RES	RES	RES	SI	RES
rw	rw		rw	rw	rw	rw	rw	rw	rw	rw	rw	rw	rw	rw	rw

Field	Bits	Type	Description
USXGMII_REACH	14:12	RW	<p>USXGMII Tx and Rx Configuration Based on the loop length between the GPHY and STA connected through USXGMII interface. No action taken if USXGMII interface is not available.</p> <p>000_B SHORT Short reach configuration of USXGMII Tx and Rx equalization by firmware</p> <p>001_B MEDIUM Medium reach configuration of USXGMII Tx and Rx equalization by firmware</p> <p>010_B LONG Long reach configuration of USXGMII Tx and Rx equalization by firmware</p> <p>011_B CUSTOM Custom Configuration At start-up default settings available after boot. If custom configuration of USXGMII Tx and Rx equalization required then the parameters can be set with custom values using GPHY API Others: Reserved.</p>
MDINT_MODE	11	RW	<p>MDIO Interrupt Mode Sets the mode of the MDIO interrupt signal.</p> <p>0_B TRI Tristate mode The MDIO interrupt signal is tristate when the interrupt is inactive. It is driven only when the interrupt is active.</p> <p>1_B PP Push-pull mode The MDIO interrupt signal is constantly driven.</p>
SI	1	RW	<p>Super Isolate Use in Super Isolate mode. Forces the device into a power down state by pin strapping (SLEEP) in which power consumption is the bare minimum required to still maintain the MII management interface communication. When activating the power down functionality, the PHY terminates active data links. The MII interface is also stopped in power down mode. See also IEEE 802.3-2008 22.2.4.1.5. The SI bit is only used to release the device from Super Isolate mode. Entering Super Isolate mode can only be activated by pin strapping at power up.</p> <p>0_B NORMAL Normal operational mode</p> <p>1_B SUPER_ISOLATE Super Isolate mode</p>

Temperature Code (Register 30.14)

Junction temperature is presented in degrees Celsius
IEEE Standard Register=30.14

VSPEC1_TEMP_STA

Reset Value

Temperature Code (Register 30.14)

0000_H

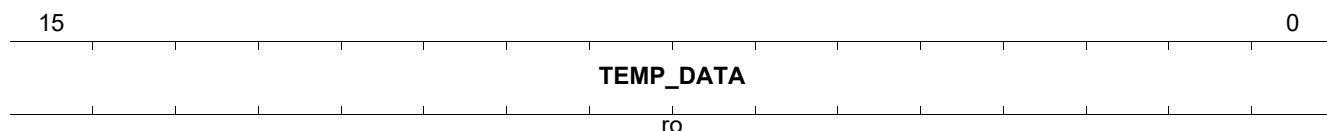

Field	Bits	Type	Description
TEMP_DATA	15:0	RO	<p>Junction Temperature</p> <p>The temperature is represented as a two's complement binary fixed point number, of which the 7 LSBs are fractional. The STA must take the thermal mitigation measures when the junction temperature exceeds the normal operating range if ADS is disabled.</p> <p>TEMP_DATA is invalid when the value is 0000_H.</p> <p>Example T_j Values (Decimal):</p> <ul style="list-style-type: none"> For T_j = -40 degC, TEMP_DATA = EC00_H For T_j = +125 degC, TEMP_DATA = 3E80_H

USXGMII Status Register (Register 30.19)

This is the USXGMII status register.

All the bits in this status register are read only. A write has no effect.

IEEE Standard Register=30.19

VSPEC1_USXGMII_STAT

Reset Value

USXGMII Status Register (Register 30.19)

0000_H

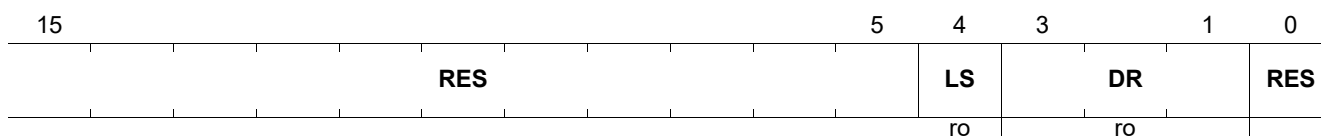

Field	Bits	Type	Description
LS	4	RO	<p>USXGMII Link Status Indicates the link status of the USXGMII.</p> <p>0_B INACTIVE The link is down. No communication with link partner is possible.</p> <p>1_B ACTIVE The link is up. Data communication with link partner is possible.</p>
DR	3:1	RO	<p>USXGMII Data Rate This field indicates the operating data rate of USXGMII when the link is up.</p> <p>000_B DR_10 USXGMII link rate is 10 Mbps.</p> <p>001_B DR_100 USXGMII link rate is 100 Mbps.</p> <p>010_B DR_1G USXGMII link rate is 1000 Mbps.</p> <p>011_B DR_ANEG USXGMII is in auto-negotiation.</p> <p>100_B DR_2G5 USXGMII link rate is 2500 Mbps.</p>

ASP Mapping to Physical Lanes (Register 30.20)

This register offers a programmable option to map physical lanes A, B, C, and D of the TPI to the ASPs. Each ASP must be mapped to each lane.

IEEE Standard Register=30.20

VSPEC1_LANE_ASP_MAP

Reset Value

ASP Mapping to Physical Lanes (Register 30.20)

00E4_H

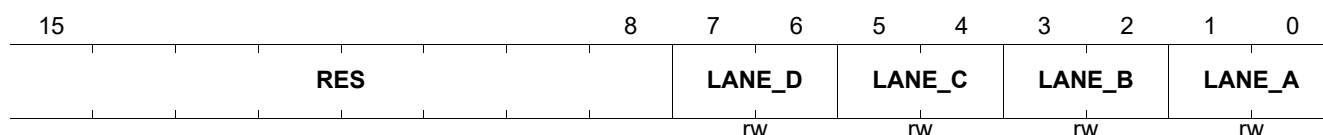

Field	Bits	Type	Description
LANE_D	7:6	RW	Map Physical Lane-D to the ASP 00 _B ASPA Map Physical Lane-D to the ASP-A 01 _B ASPB Map Physical Lane-D to the ASP-B 10 _B ASPC Map Physical Lane-D to the ASP-C 11 _B ASPD Map Physical Lane-D to the ASP-D
LANE_C	5:4	RW	Map Physical Lane-C to the ASP 00 _B ASPA Map Physical Lane-C to the ASP-A 01 _B ASPB Map Physical Lane-C to the ASP-B 10 _B ASPC Map Physical Lane-C to the ASP-C 11 _B ASPD Map Physical Lane-C to the ASP-D
LANE_B	3:2	RW	Map Physical Lane-B to the ASP 00 _B ASPA Map Physical Lane-B to the ASP-A 01 _B ASPB Map Physical Lane-B to the ASP-B 10 _B ASPC Map Physical Lane-B to the ASP-C 11 _B ASPD Map Physical Lane-B to the ASP-D
LANE_A	1:0	RW	Map Physical Lane-A to the ASP 00 _B ASPA Map Physical Lane-A to the ASP-A 01 _B ASPB Map Physical Lane-A to the ASP-B 10 _B ASPC Map Physical Lane-A to the ASP-C 11 _B ASPD Map Physical Lane-A to the ASP-D

Time to Enter Low Power (Register 30.21)

Programmable option to delay the time taken to enter low power mode.

IEEE Standard Register=30.21

VSPEC1_LOW_POWER_ENTRY_TIME

Reset Value

Time to Enter Low Power (Register 30.21)

0001_H

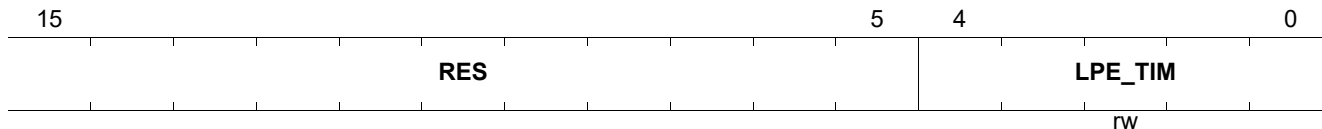

Field	Bits	Type	Description
LPE_TIM	4:0	RW	Low Power Entry Time This is the time taken from detection of no activity on the line to the low power completion. The granularity is 4 seconds and adds 2.4 seconds to 5.6 seconds on to the initial time.

Fast Retrain Control and Status (Register 30.22)

This register supports fast retrain (FR) as follows:

1. Configures the FR capability (IEEE, CISCO(THPBYP, TXDIS, EXT) [13]).
2. Records the link partner FR capability.
3. Reports the FW resolution of the FR capability.
4. Defines the maximum allowed number of times to try FR before performing a full link down.

IEEE Standard Register=30.22

VSPEC1_FRCTL
Reset Value
Fast Retrain Control and Status (Register 30.22)
0000_H

15	14	13	12	11	10	9	8	7	6	5	4	3	2	1	0
MAX_FR_*	STAT_IE*	STAT_CI*	STAT_TH*	STAT_TX*	STAT_EXT	LP_IEEE	LP_CISCO	LP_THPB*	LP_TXDIS	LP_EXT	CAP_IEEE	CAP_CIS*	CAP_THP*	CAP_TXD*	CAP_EXT
RW	ro	ro	ro	ro	ro	ro	ro	ro	ro	ro	RW	RW	RW	RW	RW

Field	Bits	Type	Description
MAX_FR_RETRY	15	RW	Maximum Number of FR Retries Before Taking Linking Down 0 _B DISABLE Maximum number of retries limited to 4. 1 _B ENABLE Maximum number of retries limited to 8.
STAT_IEEE	14	RO	Resolved for IEEE FR 0 _B DISABLE Resolved to no IEEE FR. 1 _B ENABLE Resolved to IEEE FR.
STAT_CISCO	13	RO	Resolved for CISCO FR 0 _B DISABLE Resolved to no CISCO FR 1 _B ENABLE Resolved to CISCO FR
STAT_THPBYP	12	RO	Resolved Status THP BYP during COEF_EXCH for Either CISCO FR or IEEE FR 0 _B DISABLE Resolved that THP is not BYP for either CISCO FR or IEEE FR 1 _B ENABLE Resolved that THP is BYP during COEF EXCH for either CISCO FR or IEEE FR
STAT_TXDIS	11	RO	Resolved Status for CISCO FR with TX DISABLE 0 _B DISABLE Resolved that CISCO FR is not followed by TX DISABLE after link fail signaling 1 _B ENABLE Resolved that CISCO FR is followed by TX DISABLE after link fail signaling
STAT_EXT	10	RO	Resolved Status for CISCO Extended FR Timing 0 _B DISABLE Resolved for no CISCO FR with extended timing 1 _B ENABLE Resolved for CISCO FR with extended timing
LP_IEEE	9	RO	LP Request for IEEE FR 0 _B DISABLE No advertise for IEEE FR 1 _B ENABLE Advertise capable of doing IEEE FR

Field	Bits	Type	Description (cont'd)
LP_CISCO	8	RO	LP Request for CISCO FR 0 _B DISABLE No advertise for CISCO FR 1 _B ENABLE Advertise capable of doing CISCO FR
LP_THPBYP	7	RO	LP Request for THP BYP During COEF_EXCH for Either CISCO FR or IEEE FR 0 _B DISABLE No request for THP BYP for either CISCO FR or IEEE FR 1 _B ENABLE Request for THP BYP during COEF EXCH for either CISCO FR or IEEE FR
LP_TXDIS	6	RO	LP Request for CISCO FR with TX DISABLE 0 _B DISABLE No request that CISCO FR is followed by TX DISABLE after link fail signaling 1 _B ENABLE Request that CISCO FR is followed by TX DISABLE after link fail signaling
LP_EXT	5	RO	LP Request for CISCO Extended FR Timing 0 _B DISABLE No request for CISCO FR with extended timing 1 _B ENABLE Request for CISCO FR with extended timing
CAP_IEEE	4	RW	Request for IEEE FR 0 _B DISABLE No advertise for IEEE FR 1 _B ENABLE Advertise capable of doing IEEE FR
CAP_CISCO	3	RW	Capable of Advertising CISCO FR 0 _B DISABLE No advertise for CISCO FR 1 _B ENABLE Advertise capable of doing CISCO FR
CAP_THPBYP	2	RW	Request LP for THP BYP during COEF_EXCH for Both CISCO FR and IEEE FR 0 _B DISABLE No request to LP for THP BYP for either CISCO FR or IEEE FR 1 _B ENABLE Request LP for THP BYP during COEF EXCH for either CISCO FR or IEEE FR
CAP_TXDIS	1	RW	Request for CISCO FR with TX DISABLE 0 _B DISABLE No request for CISCO FR with TX DISABLE after link fail signaling 1 _B ENABLE Advertise request that CISCO FR is followed by TX DISABLE after link fail signaling
CAP_EXT	0	RW	Request for CISCO Extended FR Timing 0 _B DISABLE No request for CISCO FR with extended timing 1 _B ENABLE Advertise request for CISCO FR with extended timing

6.5 Vendor Specific 2 Device Registers

This register file contains the GPHY-specific registers for MMD=31 (decimal).

Table 38 Registers Overview- Vendor Specific 2 Device Registers

Register Short Name	Register Long Name	Reset Value
VPSPEC2_WOL_CTL	WoL Control Register (Register 31.3590)	0000 _H
VPSPEC2_WOL_AD01	WoL Address Byte 0 and 1 (Register 31.3592)	0000 _H
VPSPEC2_WOL_AD23	WoL Address Byte 2 and 3 (Register 31.3593)	0000 _H
VPSPEC2_WOL_AD45	WoL Address Byte 4 and 5 (Register 31.3594)	0000 _H
VPSPEC2_WOL_PW01	WoL SecureON Password Byte 0 (Register 31.3595)	0000 _H
VPSPEC2_WOL_PW23	WoL SecureON Password Byte 2 and 3 (Register 31.3596)	0000 _H
VPSPEC2_WOL_PW45	WoL SecureON Password Byte 4 and 5 (Register 31.3597)	0000 _H

Wake-on-LAN Address Byte 0 and 1 (Register 31.3592)

Wake-on-LAN Address Byte 0 and 1. Redirected to PCS_PDI_WOL_AD01.

IEEE Standard Register=31.3592

VPSPEC2_WOL_AD01

Reset Value

Wake-on-LAN Address Byte 0 and 1 (Register 31.3592)

0000_H

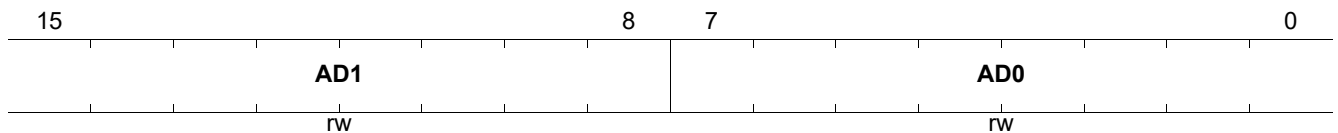

Field	Bits	Type	Description
AD1	15:8	RW	Address Byte 1 Defines byte 1 of the WoL-designated MAC address to which the PHY is sensitive.
AD0	7:0	RW	Address Byte 0 Defines byte 0 of the WoL-designated MAC address to which the PHY is sensitive.

Wake-on-LAN Address Byte 2 and 3 (Register 31.3593)

Wake-on-LAN Address Byte 2 and 3. Redirected to PCS_PDI_WOL_AD23.

IEEE Standard Register=31.3593

VPSPEC2_WOL_AD23

Reset Value

Wake-on-LAN Address Byte 2 and 3 (Register 31.3593)

0000_H

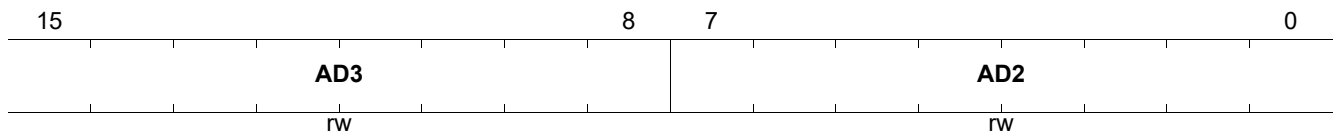

Field	Bits	Type	Description
AD3	15:8	RW	Address Byte 3 Defines byte 3 of the WoL-designated MAC address to which the PHY is sensitive.
AD2	7:0	RW	Address Byte 2 Defines byte 2 of the WoL-designated MAC address to which the PHY is sensitive.

Wake-on-LAN SecureON Password Byte 0 (Register 31.3595)

Wake-on-LAN SecureON Password Byte 0. Redirected to PCS_PDI_WOL_PWD01.

IEEE Standard Register=31.3595

VPSPEC2_WOL_PW01

Reset Value

Wake-on-LAN SecureON Password Byte 0 (Register 31.3595)

0000_H

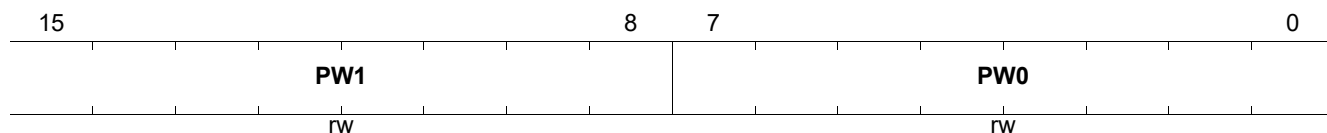

Field	Bits	Type	Description
PW1	15:8	RW	SecureON Password Byte 1 Defines byte 1 of the WoL-designated SecureON password to which the PHY is sensitive.
PW0	7:0	RW	SecureON Password Byte 0 Defines byte 0 of the WoL-designated SecureON password to which the PHY is sensitive.

Wake-on-LAN SecureON Password Byte 2 and 3 (Register 31.3596)

Wake-on-LAN SecureON Password Byte 2 and 3. Redirected to PCS_PDI_WOL_PWD23.

IEEE Standard Register=31.3596

VPSPEC2_WOL_PW23

Reset Value

Wake-on-LAN SecureON Password Byte 2 and 3 (Register 31.3596)

0000_H

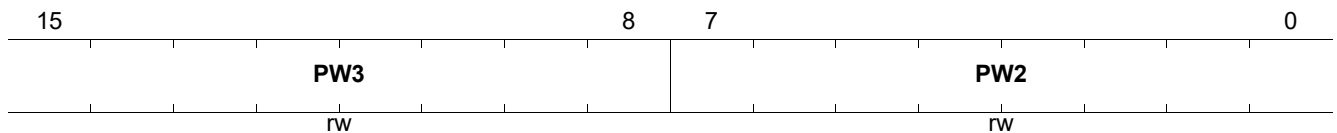

Field	Bits	Type	Description
PW3	15:8	RW	SecureON Password Byte 3 Defines byte 3 of the WoL-designated SecureON password to which the PHY is sensitive.
PW2	7:0	RW	SecureON Password Byte 2 Defines byte 2 of the WoL-designated SecureON password to which the PHY is sensitive.

Wake-on-LAN SecureON Password Byte 4 and 5 (Register 31.3597)

Wake-on-LAN SecureON Password Byte 4 and 5. Redirected to PCS_PDI_WOL_PWD45.

IEEE Standard Register=31.3597

VPSPEC2_WOL_PW45

Reset Value

Wake-on-LAN SecureON Password Byte 4 and 5 (Register 31.3597)

0000_H

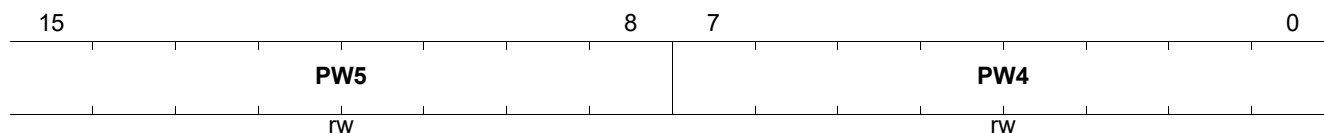

Field	Bits	Type	Description
PW5	15:8	RW	SecureON Password Byte 5 Defines byte 5 of the WoL-designated SecureON password to which the PHY is sensitive.
PW4	7:0	RW	SecureON Password Byte 4 Defines byte 4 of the WoL-designated SecureON password to which the PHY is sensitive.

7 Electrical Characteristics

This chapter provides the electrical characteristics for the MxL86282S.

7.1 Absolute Maximum Ratings

Table 39 shows the absolute maximum ratings for the MxL86282S.

Table 39 Absolute Maximum Ratings

Parameter	Symbol	Values			Unit	Note / Test Condition
		Min.	Typ.	Max.		
Storage Temperature Limits	T _{STG}	-55.0	–	125.0	°C	–
Soldering Temperature	T _{SOL}	–	–	260.0	°C	Compliance with lead free re-flow soldering profile as J-STD-020D
Moisture Level 3 Temperature Limits	T _{ML3}	–	–	260.0	°C	According to IPS J-STD 020
Absolute Junction Temperature	T _{JABS}	-40.0		125	°C	The thermal solution must ensure that T _J never exceeds T _{JABS} maximum. The chip resets the device when T _J > T _{JABS} maximum to prevent any damage to occur.
DC Voltage Limits on VDD3V3PAD1, VDD3V3PAD2 Pins	V _{DDP3V3}	-0.5	–	+3.63	V	Generic ball V _{HIGH} supply
DC Voltage Limits on VDDP_PAD Pins when Ball K4 Pin Strap PS_MDIO_VOLTAGE is HIGH	V _{DDP}	-0.5	–	+3.63	V	Multi voltage ball V _{HIGH} supply
DC Voltage Limits on VDDP_PAD Pins when Ball K4 Pin Strap PS_MDIO_VOLTAGE is LOW	V _{DDP}	-0.5	–	+1.98	V	Multi voltage ball supply. 1.8 V supply dedicated to MDIO pins in lower mode
DC Voltage Limits on VDDA3V3_0, VDDA3V3_1, VDDA3V3_2, VDDA3V3_3, VDDA3V3_4, VDDA3V3_5, VDDA3V3_6, and VDDA3V3_7 Pins	V _{DDA3V3}	-0.5	–	+3.63	V	Chip analog V _{HIGH} supply
DC Voltage Limits on VDDA1V8_0, VDDA1V8_1 Pins	V _{DDA1V8}	-0.5	–	+1.98	V	Chip analog supply

Electrical Characteristics
Table 39 Absolute Maximum Ratings (cont'd)

Parameter	Symbol	Values			Unit	Note / Test Condition
		Min.	Typ.	Max.		
DC Voltage Limits on VDDA1V8PORXO, VDDA1V8_PVT, VCC1V8_OTP, and VDDA1V8_C ML Pins	$V_{\text{DDA1V8PORXO}}$ $V_{\text{DDA1V8PVT}}$ V_{CC1V8OTP} $V_{\text{DDA1V8CML}}$	-0.5	–	+1.98	V	Chip clocking supply
DC Voltage Limits on VPHA1V8_0, VPHA1V8_1, and VDDA1V8_PLL Pins	V_{PH} $V_{\text{DDA1V8PLL}}$	-0.5	–	+1.98	V	USXGMII, LJ PLL V_{HIGH} supply
DC Voltage Limits on VDDA1V2CDB0, VDDA1V2CDB1 Pins	$V_{\text{DDA1V2CDB}}$	-0.5	–	+1.32	V	Chip analog supply
DC Voltage Limits on VDDA0V8_0, VDDA0V8_1, VDDD0V8REF, VDDD0V8POST, and VDDA0V8_CML Pins	V_{DDA0V8} $V_{\text{DDD0V8PLL}}$ $V_{\text{DDA0V8CML}}$	-0.5	–	+0.88	V	Chip analog V_{LOW} supply, LJ PLL V_{LOW} supply
DC Voltage Limits on VDDD0V8_COR Pins	V_{DD}	-0.5	–	+0.88	V	Chip core supply
DC Voltage Limits on VA0V8_0, VA0V8_1 Pins	V_{P}	-0.5	–	+0.88	V	USXGMII V_{LOW} supply
DC Voltage Limits on Any Other Pins ¹⁾ with Respect to Ground	V_{DC}	-0.5	–	$V_{\text{DDP3V3}} + 0.5$	V	Unless specified otherwise
XTAL1 Input Voltage	V_{XTAL1}	-0.30	–	2.0	V	–
ESD HBM Robustness	$V_{\text{ESD,HBM}}$	–	–	1000.0	V	According to ANSI/ESDA/JEDEC JS-001-2014
ESD CDM Robustness	$V_{\text{ESD,CDM}}$	–	–	250.0	V	According to ANSI/ESDA/JEDEC JS-002-2014

1) Any pin that is not a supply pin out of one of the domains: V_{DDP} , V_{PH} , V_{P} , V_{DDA3V3} , $V_{\text{DDA1V8PORXO}}$, $V_{\text{DDA1V2CDB}}$, V_{DDA0V8} , V_{DD} , and V_{DDA1V8} .

Attention: Stresses above the maximum values listed in this table may cause permanent damage to the device. Exposure to absolute maximum rating conditions for extended periods may affect device reliability. Maximum ratings are absolute ratings; exceeding only one of these values may cause irreversible damage to the device.

7.2 Operating Range

Table 40 defines the limit values of voltages and temperature which may be applied to guarantee proper operation of the MxL86282S.

Table 40 Operating Range

Parameter	Symbol	Values			Unit	Note / Test Condition
		Min.	Typ.	Max.		
Ambient Temperature under Bias	T_A	0	–	70	°C	The thermal design must ensure that the maximum junction temperature is not exceeded. The use of a heat sink may be suitable.
Junction Temperature	T_j	–	–	110.0	°C	Thermal solution must ensure that T_j remains within operating range and never exceeds maximum absolute ratings (T_{JABS}).
Generic Pin Supply Voltage	V_{DDP3V3}	3.14	3.30	3.46	V	Generic pin V_{HIGH} supply
Multi Voltage Pin Supply Voltage for MDIO Signals when Ball K4 Pin Strap PS_MDIO_VOLTAGE is HIGH	V_{DDP}	3.14	3.30	3.46	V	Multi voltage pin V_{HIGH} supply
Multi Voltage Pin Supply Voltage for MDIO Signals when Ball K4 Pin Strap PS_MDIO_VOLTAGE is LOW	V_{DDP}	1.71	1.80	1.89	V	Multi voltage pin supply. 1.8 V supply dedicated to MDIO pins in lower mode
Analog High Supply Voltage	V_{DDA3V3}	3.14	3.30	3.46	V	Chip analog V_{HIGH} supply
XO Supply Voltage	$V_{DDA1V8POR}$ XO	1.71	1.80	1.89	V	Chip clocking V_{HIGH} supply
Analog Medium Supply Voltage	V_{DDA1V8}	1.71	1.80	1.89	V	Chip analog V_{MED} supply
CDB Supply Voltage	$V_{DDA1V2CDB}$	1.14	1.20	1.26	V	Chip analog supply
USXGMII High Supply Voltage	V_{PH}	1.71	1.80	1.89	V	USXGMII V_{HIGH} supply
LJ PLL High Supply Voltage	$V_{DDA1V8PLL}$	1.71	1.80	1.89	V	LJ PLL V_{HIGH} supply
Analog Low Supply Voltage	V_{DDA0V8}	0.76	0.8	0.84	V	Chip analog V_{LOW} supply
LJ PLL Low Supply Voltage	$V_{DDD0V8PLL}$	0.76	0.8	0.84	V	LJ PLL V_{LOW} supply
Chip Core Supply Voltage	V_{DD}	0.76	0.8	0.84	V	Chip core supply
USXGMII Low Supply Voltage	V_P	0.76	0.8	0.84	V	USXGMII V_{LOW} supply
Ground	V_{SS}	0.00	0.00	0.00	V	–

Attention: Operations above the maximum values listed here for extended periods may adversely affect long-term reliability of the device.

7.3 Typical Power Consumption

Table 41 lists the typical power consumption for different modes. Typical power is the power consumed by a nominal process device, nominal supply voltages, at 25°C ambient temperature and a CAT5e link segment.

The conditions for Link-up are full speed and bidirectional, full duplex traffic on all 8 ports. There are 10G links on both SerDes interfaces. The switch operates at 40 Gbps wirespeed with 10 ports.

Table 41 Typical Power Consumption

	3.3 V V _{HIGH} Domain Current	1.8 V Domain Current	1.2 V Domain Current	0.8 V V _{LOW} Domain Current	0.8 V V _P Domain Current	Chip Power
Unit	mA	mA	mA	mA	mA	W
2500BASE-T Link-up, 100 m Cable	390	143	473	3881	125	5.3
2500BASE-T Link-up, 30 m Cable	372	136	445	3401	127	4.8
2500BASE-T EEE	298	125	133	1634	130	2.8
1000BASE-T Link-up, 100 m Cable	300	138	436	1875	124	3.4
1000BASE-T EEE	34	130	118	896	130	1.3
100BASE-TX Link-up, 100 m Cable	106	129	111	1046	122	1.6
100BASE-TX EEE	33	125	118	669	129	1.1
10BASE-Te Link-up, 100 m Cable	110	126	65	1043	117	1.6
Cable Unplugged - ANEG	51	131	65	654	120	1.1
Cable Unplugged - Low Power	30	120	6	346	119	0.7
Reset	5	24	1	61	0	0.1

7.4 Maximum Thermal Design Power

Table 42 lists the maximum Thermal Design Power (TDP). The TDP is the power consumption for a full traffic load and worst-case process, supply voltage, cable, and temperature conditions. This value is relevant to design the thermal solution.

Table 42 Maximum Power Consumption

Condition	Maximum Power (W)
Maximum Chip Power at Maximum Operating Range	7.5

Note: With a properly designed thermal solution (heat sink), it is unlikely that T_j exceeds the maximum operating junction temperature. An excess is reported in the MDIO register VSPEC1_TEMP_STA and the STA can initiate a renegotiation to a lower link rate to get T_j back into the operating temperature range if ADS is disabled.

7.5 Maximum Current

Table 43 provides the maximum current to dimension the power supply. It is the maximum current consumption per rail for a full traffic load and worst-case process, supply voltage and temperature conditions that may occur in any operating state of the device. The maximum current can be higher than the steady state current, for instance in training phases of the internal filters.

Electrical Characteristics

Table 43 Maximum Current Per Rail

3.3 V Domain Current	1.8 V Domain Current	1.2 V Domain Current	0.8 V V_{LOW} Domain Current	0.8 V V_P Domain Current
mA	mA	mA	mA	mA
475	155	587	6511	203

7.6 DC Characteristics

These sections document the DC characteristics of the MxL86282S external interfaces.

7.6.1 Digital Interfaces

This section defines the DC characteristics of the GPIO interface as follows:

- General Purpose IO
- MDIO
- QSPI
- UART
- I²C
- Interrupts
- Clock Input and Outputs
- LED
- JTAG
- HRSTN

Table 44 summarizes the DC characteristics for $V_{DDP} = 3.3$ V.

Table 44 DC Characteristics of the GPIO Interfaces (VDDP = 3.3 V)

Parameter	Symbol	Values			Unit	Note / Test Condition
		Min.	Typ.	Max.		
Input High Voltage	V_{IH}	$0.7 \cdot V_{DDP}$	–	$V_{DDP} + 0.3$	V	–
Input Low Voltage	V_{IL}	–0.3	–	$0.3 \cdot V_{DDP}$	V	–
Output High Voltage	V_{OH}	$V_{DDP} - 0.4$	–	–	V	$I_{OH} = 2, 4, 8, 12$ mA
Output Low Voltage	V_{OL}	–	–	0.4	V	$I_{OL} = 2, 4, 8, 12$ mA

Table 45 summarizes the DC characteristics for $V_{DDP} = 1.8$ V.

Table 45 DC Characteristics of the GPIO Interfaces (VDDP = 1.8 V¹⁾)

Parameter	Symbol	Values			Unit	Note / Test Condition
		Min.	Typ.	Max.		
Input High Voltage	V_{IH}	$0.65 \cdot V_{DDP}$	–	$V_{DDP} + 0.3$	V	–
Input Low Voltage	V_{IL}	–0.3	–	$0.35 \cdot V_{DDP}$	V	–
Output High Voltage	V_{OH}	$V_{DDP} - 0.4$	–	–	V	$I_{OH} = 2, 4, 8, 12$ mA
Output Low Voltage	V_{OL}	–	–	0.4	V	$I_{OL} = 2, 4, 8, 12$ mA

1) 1.8V is only applicable to the pins specified in **PS_MDIO_VOLTAGE** of **Table 17**.

7.6.2 Twisted Pair Interface

The TPI conforms to the specifications of 10BASE-Te (Clause 14), 100BASE-TX (Clause 25), 1000BASE-T (Clause 40), and 2.5GBASE-T (Clause 126) given in IEEE802.3, and ANSI X3.263-1995.

7.6.3 Built-in Temperature Sensor

Table 46 provides the parameters of the integrated temperature sensor.

Table 46 Temperature Sensor Characteristics

Parameter	Symbol	Values			Unit	Note / Test Condition
		Min.	Typ.	Max.		
Temperature Range	T _{range}	-40		125	°C	The thermal mitigation measures must ensure that T _j remains within the operating range. When T _j exceeds the maximum ratings, the device performs a self-reset to prevent damage.
Resolution		–	12	–	bits	–
Accuracy		-3	–	+3	°C	Without calibration

7.7 AC Characteristics

The AC characteristics of the external interfaces are specified under these operating conditions:

$$T_A = 0 \text{ to } 70^\circ\text{C}$$

$$V_{DDP} = 3.3 \text{ V} \pm 5\%$$

$$V_{SS} = 0 \text{ V}$$

The timing measurements are made at minimum V_{IH} for a logical 1 and at maximum V_{IL} for a logical 0. See [Table 44](#) and [Table 45](#) for more details.

[Figure 24](#) shows the AC testing input/output waveforms. The load capacitors are according to the specific interface standard. All non-specified interfaces use 30 pF as assumed loading.

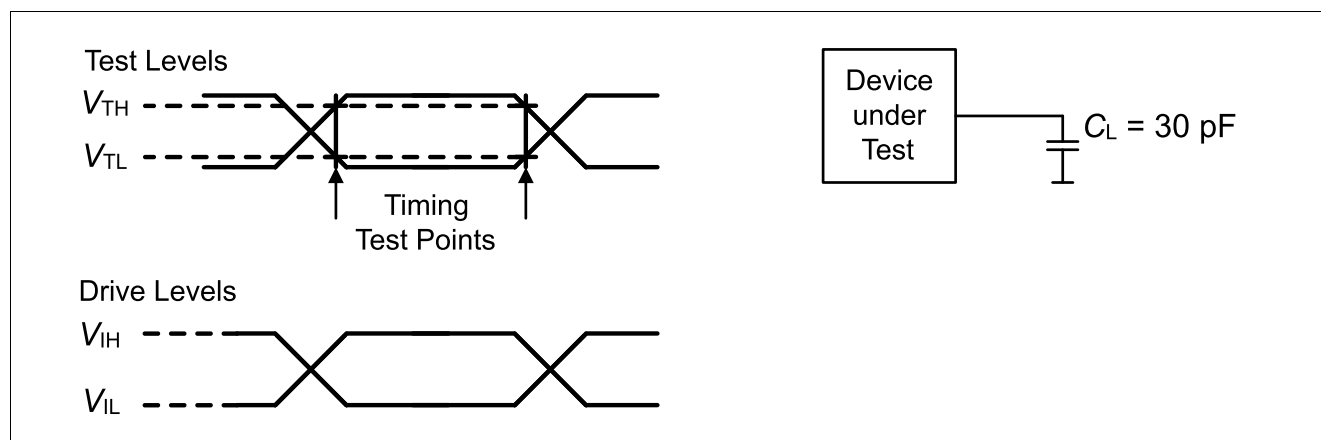

Figure 24 Input/Output Waveform for AC Tests

7.7.1 Power Up Sequence

All V_{HIGH} , V_{PH} , V_{DDA} , V_P , and V_{LOW} are supplied externally.

In this section, for the sake of simplicity:

- All 3.3 V supplies are represented as V_{HIGH} .
- All 1.8 V supplies are represented as V_{PH} .
- All 1.2 V supplies are represented as V_{DDA} .
- The 0.8 V analog supply of SerDes is represented as V_P .
- The rest of the 0.8 V supplies are represented as V_{LOW} .

All the supply domains V_{HIGH} , V_{PH} , V_{DDA} , V_P , and V_{LOW} , and the input reference clock must be stabilized before releasing the reset HRSTN.

There is no known voltage rail power up sequence except that V_{HIGH} must be ramped up and stable before V_{PH} is ramped up, V_{LOW} must be ramped up and stable before V_P is ramped up, and V_{LOW} must be ramped up and stable before V_{PH} is ramped up. MaxLinear recommends implementing the power-up sequence defined in the reference board. Refer to the relevant hardware documentation available at <https://maxlinear.com/myMxL> for more information on the power circuitry.

The MxL86282S supports an asynchronous hardware reset HRSTN. [Table 47](#) lists the timing requirements of the power supply pins. The timings refer to the signal sequence waveforms depicted in [Figure 25](#).

When PS_MDIO_VOLTAGE is low, V_{DDP} is treated as V_{PH} .

When PS_MDIO_VOLTAGE is high, V_{DDP} is treated as V_{HIGH} .

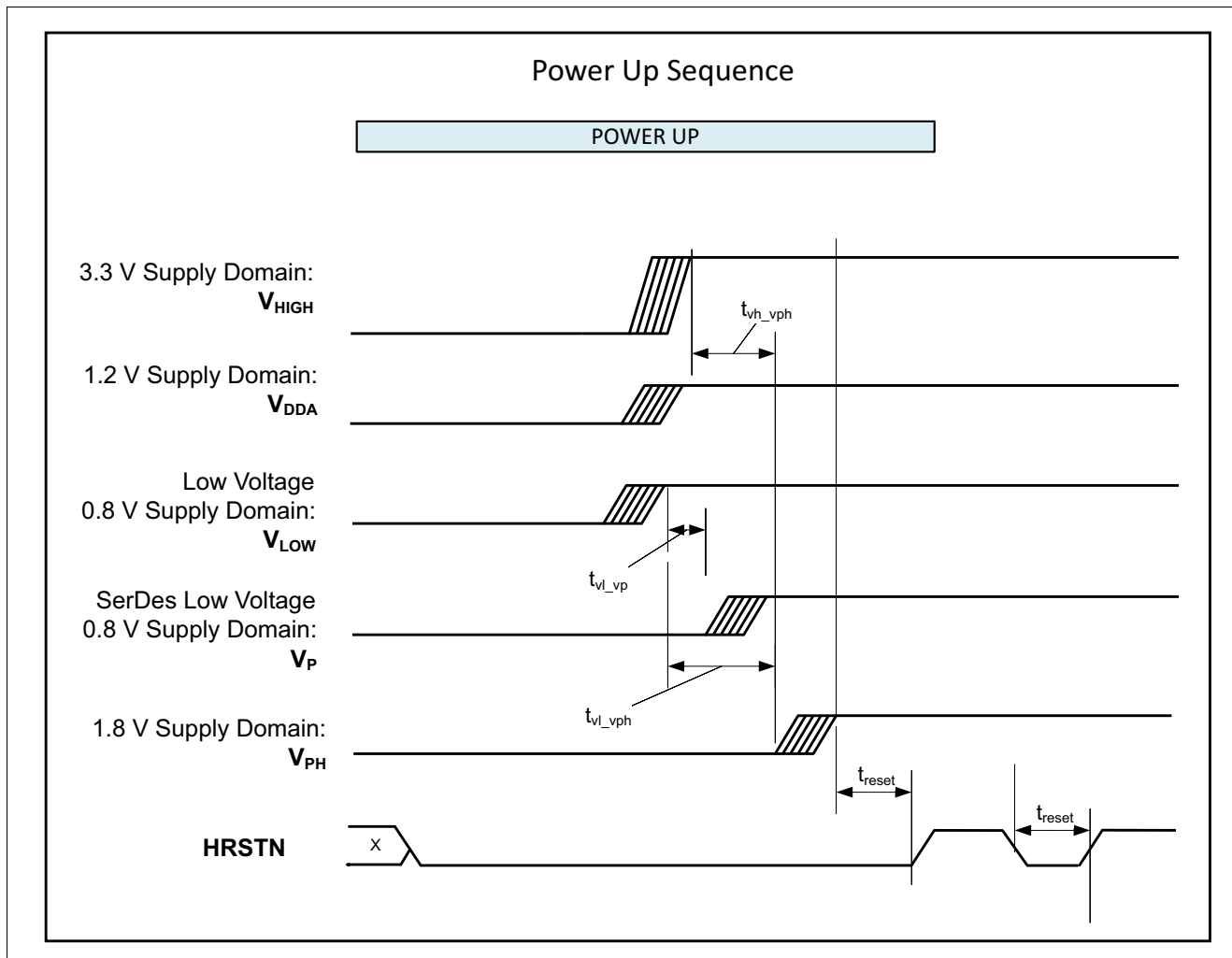

Figure 25 Timing Diagram for the Reset Sequence

Table 47 Power Supply Timings

Parameter	Symbol	Values			Unit	Note / Test Condition
		Min.	Typ.	Max.		
Delay between V_{HIGH} and V_{PH} Domains Voltage Ramp Up	t_{vh_vph}	50	-	-	μs	The V_{PH} voltage must never be higher than V_{HIGH} voltage
Delay between V_{LOW} and V_P Domains Voltage Ramp Up	t_{vl_vp}	1	-	-	μs	The V_P voltage must never power up before V_{LOW} voltage.
Delay between V_{LOW} and V_{PH} Domains Voltage Ramp Up	t_{vl_vph}	50	-	-	μs	The V_{PH} voltage must never power up before V_{LOW} voltage.
Reset Time after all Voltage Domains are Stabilized	t_{reset}	100	-	-	ns	HRSTN must be released after the power supplies stabilized.

7.7.2 Input Clock

Table 48 lists the input clock requirements when not using a crystal, for example when an external reference clock is injected into the XTAL1 pin of the MxL86282S, such as nominal frequency, frequency deviation, duty cycle, and signal characteristics. When a crystal is applied to generate the reference clock using the integrated XO, the clock requirements stated here are explicitly met as long as the specification for the crystal is satisfied.

Table 48 AC Characteristics of Input Clock on XTAL1 Pin

Parameter	Symbol	Values			Unit	Note / Test Condition
		Min.	Typ.	Max.		
Frequency with 25 MHz Input	f_{clk25}	–	25.0	–	MHz	–
Frequency with 50 MHz Input	f_{clk50}	–	50.0	–	MHz	–
Frequency Deviation ¹⁾		-50.0	–	+50.0	ppm	–
Duty Cycle		40.0	50.0	60.0	%	–
Rise/Fall Times with 25 MHz Input		–	–	10.0	ns	25 MHz
Rise/Fall Times with 50 MHz Input		–	–	5.0	ns	50 MHz
Input Long Term Jitter (Jrms)		–	–	2.0	ps	1 kHz to 10 MHz
Input Voltage Swing		300.0	–	–	mV	Peak to Peak value
Input Voltage		0	–	1.8	V	–

1) Including the frequency stability tolerance due to temperature, and aging effects over the product lifetime.

7.7.3 Power Supply Rail Requirements

Table 49 lists the required characteristics of the power supplies. The definitions of the power supply rails are the same as that described in [Section 7.7.1](#).

Table 49 AC Characteristics of the Power Supply

Parameter	Symbol	Values			Unit	Note / Test Condition
		Min.	Typ.	Max.		
Power Supply Ripple on V_P	R_{VP}	–	–	40.0	mV	Peak to Peak value See Figure 26 .
Power Supply Ripple on V_{LOW}	R_{VLOW}	–	–	40.0	mV	Peak to Peak value
Power Supply Ripple on V_{DDA}	R_{VDDA}	–	–	50.0	mV	Peak to Peak value
Power Supply Ripple on V_{HIGH}	R_{VHIGH}	–	–	50.0	mV	Peak to Peak value
Power Supply Ripple on V_{PH}	R_{VPH}	–	–	50.0	mV	Peak to Peak value Max. 18 mV peak to peak for any noise in 200 kHz to 100 MHz range. See Figure 27 .

7.7.3.1 V_P AC and DC Power Supply Recommendations

This section contains the V_P supply power requirements.

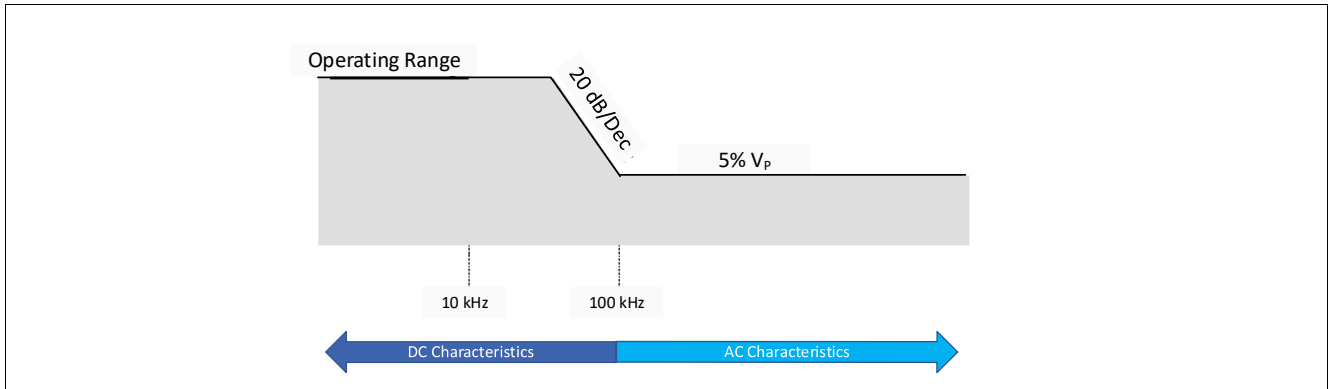

Figure 26 DC and AC Characteristics for V_P Supply

DC Characteristics

- Operating range: See the range of V_P in [Table 40](#)
- Frequency range: 0 to 100 kHz
- Recommendations:
 - The overshoot or undershoot of the low-frequency supply caused by the board filter network should be lower than 100 kHz.
 - The overall DC budget should account for the low frequency overshoot/undershoot in addition to the board plus package IR drop.
 - There is a transition zone between 10 kHz and 100 kHz in which it is possible for the supply noise to increase as the frequency decreases at a rate of 20 dB/Dec up to the maximum of the operating range.

AC Characteristics

- Max 5% (peak-to-peak) of the DC level for all noise greater than 100 kHz
- Recommendations:
 - A switching supply can be used until the overall noise limits (including, the self noise) are met.

7.7.3.2 V_{PH} AC and DC Power Supply Recommendations

This section contains the V_{PH} supply power requirements.

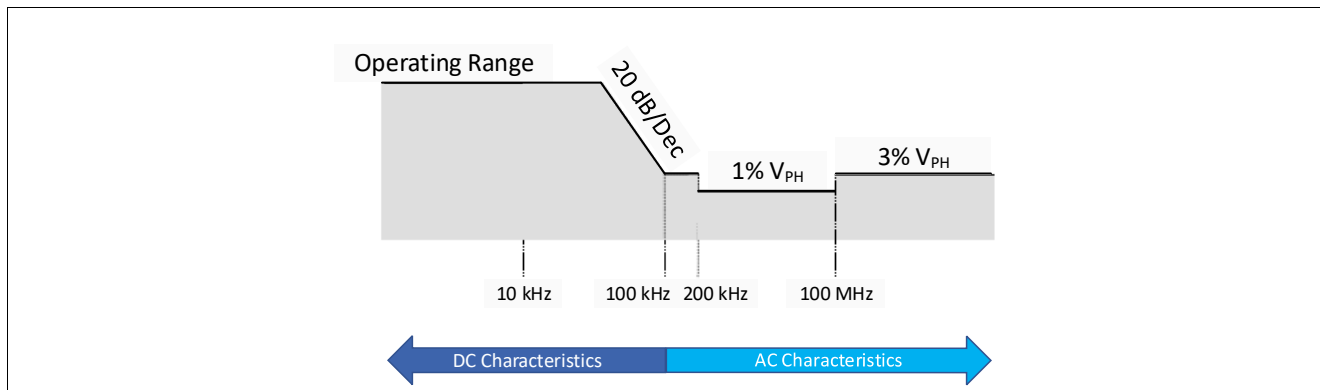

Figure 27 DC and AC Characteristics for V_{PH} Supply

DC Characteristics

- Operating range: See the range of V_{PH} in [Table 40](#)
- Frequency range: 0 to 100 kHz
- Recommendations:
 - The overshoot or undershoot of the low-frequency supply caused by the board filter network should be lower than 100 kHz.
 - The overall DC budget should account for the low frequency overshoot/undershoot in addition to the board plus package IR drop.
 - There is a transition zone between 10 kHz and 100 kHz in which it is possible for the supply noise to increase as the frequency decreases at a rate of 20 dB/Dec up to the maximum of the operating range.

AC Characteristics

- 100 kHz to 200 kHz: A maximum value of 3% ripple (peak-to-peak) of the DC level is allowed for all noise in this region.
- 200 kHz to 100 MHz: A maximum value of 1% ripple (peak-to-peak) of the DC level is allowed in this region.
- 100 MHz and above: A maximum value of 3% ripple (peak-to-peak) of the DC level is allowed for all noise in this region.
- Recommendations:
 - Use an LDO as a switching supply.
 - When using a switching power supply for V_{PH} , ensure that the 200 kHz to 100 MHz ripple requirements are met. Switching power supplies' tone and harmonics typically occur in this region.
 - Do not share this power rail directly with any other noisy circuitry.
 - Follow the relevant hardware documentation available at <https://maxlinear.com/myMxL> on the power circuitry.

7.7.4 MDIO Slave Interface

Figure 28 shows a timing diagram of the MDIO slave interface for a clock cycle in the read, write, and turnaround mode, respectively. The timing measures are annotated. **Table 50** summarizes the defined absolute values.

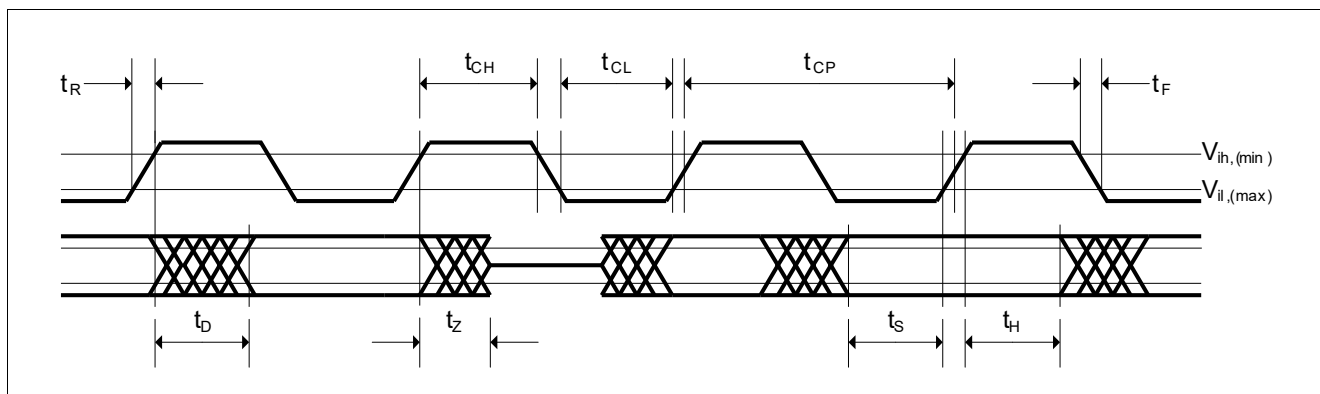

Figure 28 Timing Diagram for the MDIO Slave Interface

Table 50 Timing Characteristics of the MDIO Slave Interface

Parameter	Symbol	Values			Unit	Note / Test Condition
		Min.	Typ.	Max.		
MDC High Time	t_{CH}	10.0	–	–	ns	The MDC signal must conform to the specified MDC timings when measured at the MxL86282S's MDC_S pin.
MDC Low Time	t_{CL}	10.0	–	–	ns	
MDC Clock Period	t_{CP}	40.0	400.0	–	ns	
MDC Clock Frequency ¹⁾	t_{CP}	–	2.5	25.0	MHz	
MDC Rise Time	t_R	–	–	5.0	ns	
MDC Fall Time	t_F	–	–	5.0	ns	
MDIO Input Setup Time Subject to ↑ MDC	t_S	10.0	–	–	ns	MxL86282S Receive
MDIO Input Hold Time Subject to ↑ MDC	t_H	10.0	–	–	ns	MxL86282S Receive
MDIO Output Delay Time Subject to ↑ MDC	t_D	0.0	–	10	ns	MxL86282S Transmit
Standard at 2.5 MHz						
MDIO Output Delay Subject to ↑ MDC	t_D	0.0	–	300.0	ns	PHY Transmit

1) The MDC clock supports a range of frequencies up to 25 MHz. The default/typical frequency is 2.5 MHz.

7.7.5 MDIO Master Interface

Figure 29 shows the timing diagram of the MDIO master interface for a clock cycle in the read-, write- and turnaround-mode, respectively. The timing measures are annotated. **Table 51** summarizes the defined absolute values.

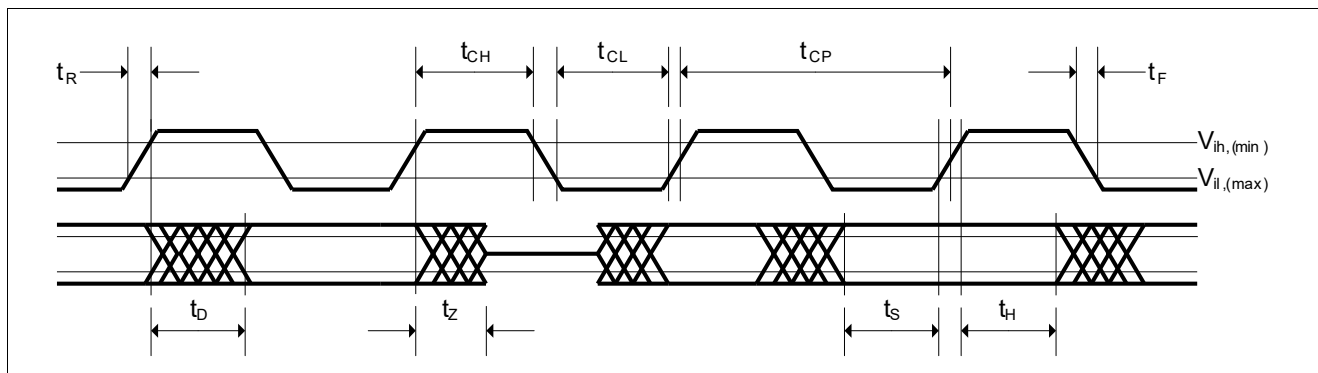

Figure 29 Timing Diagram for the MDIO Master Interface

Table 51 Timing Characteristics of the MDIO Master Interface

Parameter	Symbol	Values			Unit	Note / Test Condition
		Min.	Typ.	Max.		
MDC High Time	t_{CH}	5.0	–	–	ns	Given timings are all subject to the MDC at the pin of the MxL86282S.
MDC Low Time	t_{CL}	5.0	–	–	ns	
MDC Clock Period	t_{CP}	20.0	400.0	–	ns	
MDC Clock Frequency ¹⁾	t_{CP}	–	2.5	50.0	MHz	
MDC Rise Time	t_R	–	–	2.5	ns	
MDC Fall Time	t_F	–	–	2.5	ns	
MDIO Input Setup Time Subject to - MDC	t_S	8.0	–	–	ns	MAC receive
MDIO Input Hold Time Subject to - MDC	t_H	0.0	–	–	ns	MAC receive
MDIO Output Setup Time Subject to - MDC	t_S	7.0	–	–	ns	MAC transmit
MDIO Output Hold Time Subject to - MDC	t_H	7.0	–	–	ns	MAC transmit
Standard						
MDIO Output Delay Subject to - MDC	t_D	0.0	–	300.0	ns	PHY transmit
MDIO Output Setup Time Subject to - MDC	t_S	10.0	–	–	ns	MAC transmit
MDIO Output Hold Time Subject to - MDC	t_H	10.0	–	–	ns	MAC transmit

1) MDC clock supports range of frequencies, up to 50 MHz. Default/typical frequency is 2.5 MHz.

7.7.6 Quad Serial Peripheral Interface (QSPI)

Figure 30 shows the QSPI master timing.

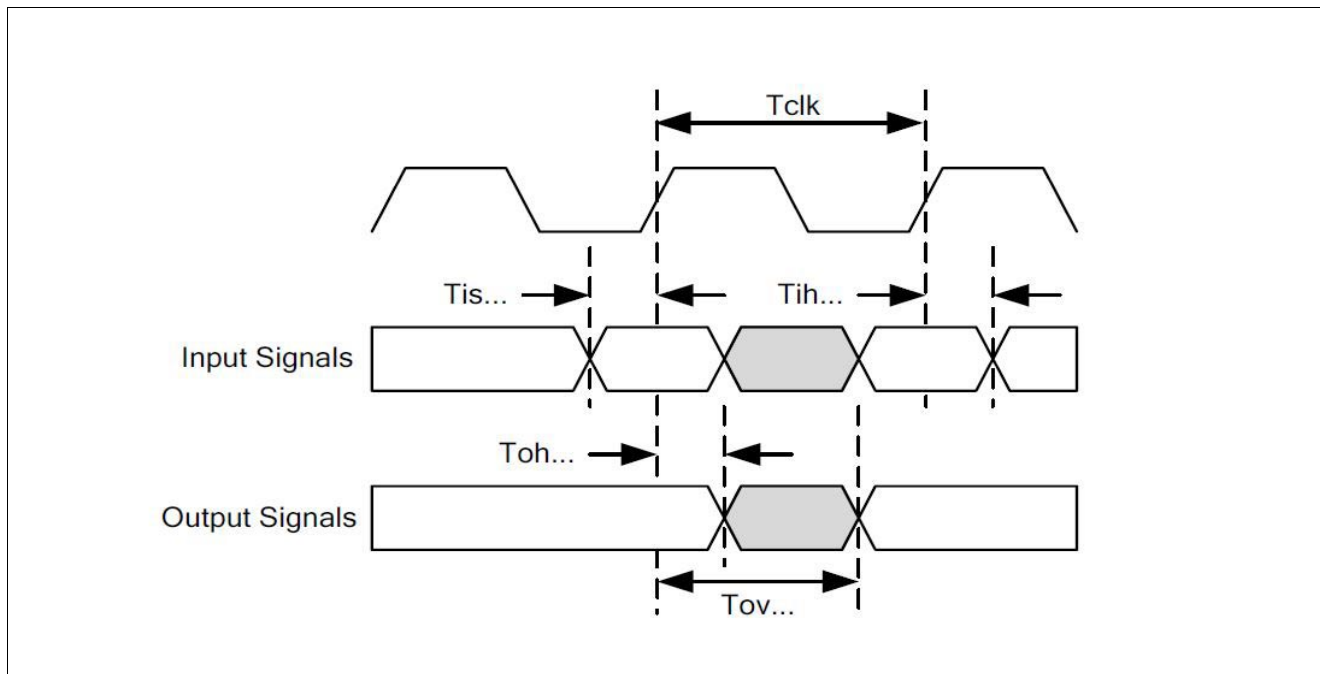

Figure 30 QSPI Master Interface Timing

Table 52 QSPI Interface Timing Parameters

Parameter	Symbol	Values			Unit	Note / Test Condition
		Min.	Typ.	Max.		
Master Mode						
TX Data Output Hold	T_{oh}	5%	–	–	Tclk	For Tclk = 20 ns
Tx Data Output Delay	T_{ov}	0	–	50%	Tclk	For Tclk = 20 ns
Rx Data Input Setup time	T_{is}	35%	–	–	Tclk	For Tclk = 20 ns
Rx Data Hold Time	T_{ih}	5%	–	–	Tclk	For Tclk = 20 ns
SPI Clock Period (Master Mode)	T_{clk}	9.846	–	–	ns	Maximum 101.5625 MHz
SPI Clock Rising	S_7	0.1	–	–	V/ns	–
SPI Clock Falling	S_6	0.1	–	–	V/ns	–

7.7.7 I²C Interface

Figure 31 shows the I²C interface timing.

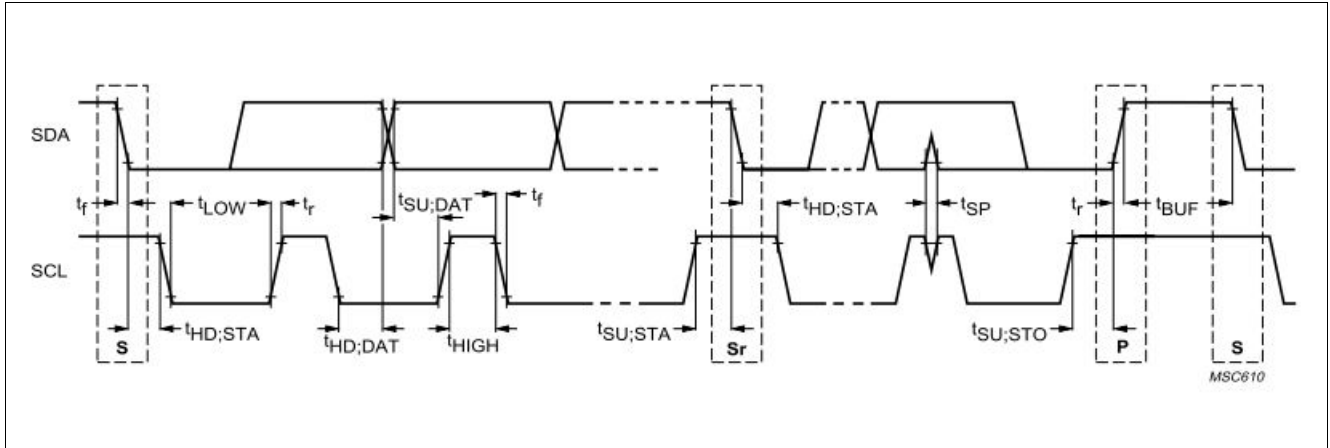

Figure 31 I²C Timing

Table 53 describes the timing values.

Table 53 I²C Timing

Parameter	Symbol	Values			Unit	Note / Test Condition
		Min.	Typ.	Max.		
SCL Frequency	f_{SCL}	0	–	100	kHz	–
Setup Time Data to Shift Clock	$t_{SU,DAT}$	250	–	–	ns	–
Hold Time Data to Shift Clock	$t_{HD,DAT}$	0	–	3.45	μ s	–
Setup Time START to Shift Clock	$t_{SU,STA}$	4700	–	–	ns	–
Hold Time START, STOP to Shift Clock	$t_{HD,STA/STO}$	4.0	–	–	μ s	–
Low Time	t_{LOW}	4700	–	–	ns	–
High Time	t_{HIGH}	4000	–	–	ns	–
Rising Time	t_r	–	–	1000	ns	–
Falling Time	t_f	–	–	300	ns	–
Bus Free Time	t_{BUF}	4700	–	–	ns	–

7.7.8 JTAG Interface

The JTAG test interface is used for debugging the CPU and boundary scan.

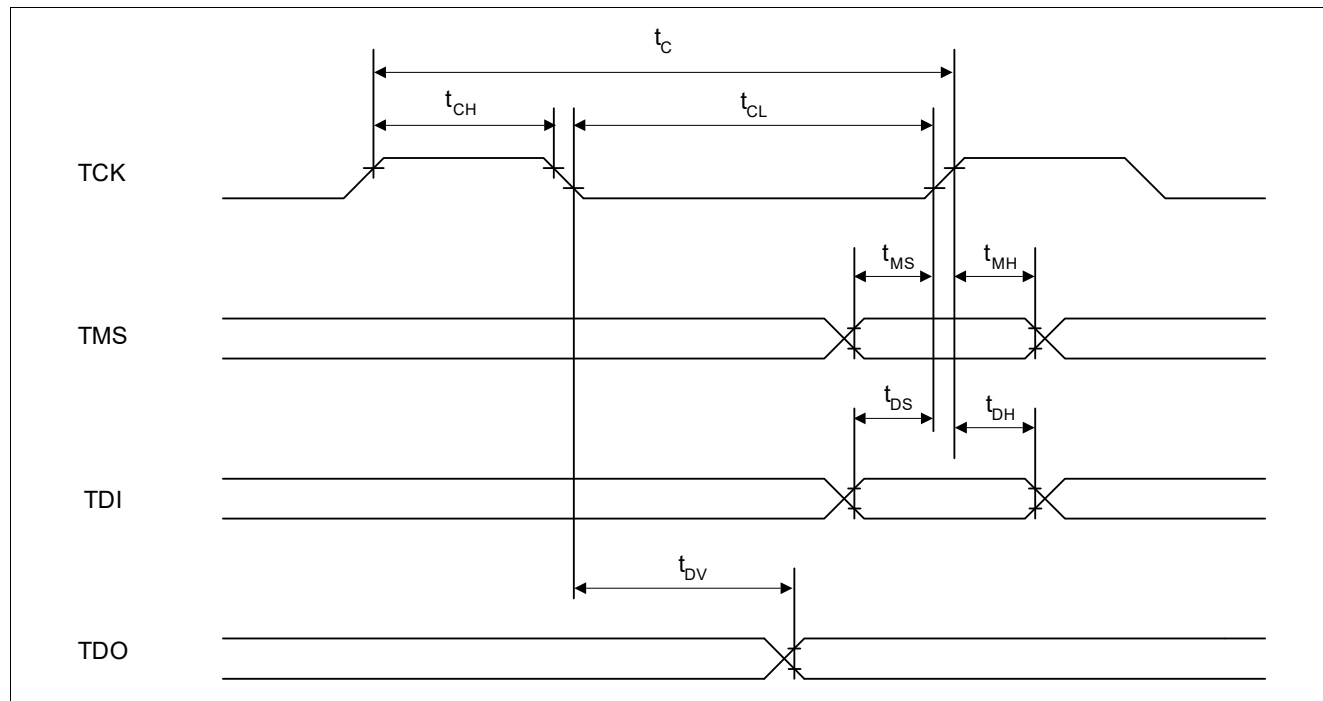

Figure 32 Test Interface Timing

Table 54 and Table 55 describe the timing values for the test interface.

Table 54 Test Interface Clock

Parameter	Symbol	Values			Unit	Note / Test Condition
		Min.	Typ.	Max.		
TCK Clock Period	t_C	100	–	–	ns	–
TCK High Time	t_{CH}	40	–	–	ns	–
TCK Low Time	t_{CL}	40	–	–	ns	–

Table 55 JTAG Timing

Parameter	Symbol	Values			Unit	Note / Test Condition
		Min.	Typ.	Max.		
TMS Setup Time	t_{MS}	40	–	–	ns	–
TMS Hold Time	t_{MH}	40	–	–	ns	–
TDI Setup Time	t_{DS}	40	–	–	ns	–
TDI Hold Time	t_{DH}	40	–	–	ns	–
Hold: TRSTN After TCK	t_{HD}	10	–	–	ns	–
TDO Valid Delay	t_{DV}	–	–	60	ns	–

7.7.9 USXGMII Interface Characteristics

This section describes the AC characteristics of the USXGMII interface on the MxL86282S.

The USXGMII interface characteristics are described in:

- USXGMII transmit characteristics ([Section 7.7.9.1](#))
- USXGMII receive characteristics ([Section 7.7.9.2](#))

7.7.9.1 USXGMII Transmit Characteristics

[Table 56](#) shows the requirements of the USXGMII interface on the MxL86282S.

Table 56 Transmit Characteristics of the USXGMII

Parameter	Symbol	Values			Unit	Note / Test Condition
		Min.	Typ.	Max.		
Reference Differential Impedance	Z_d	–	100	–	Ω	–
Termination Mismatch	R_M	–	–	5	%	–
DC Common Mode Voltage	V_{cm}	0	–	3.6	V	–
Output Rise and Fall Time	t_{RH}, t_{FH}	24	–	–	ps	20%→80%
Output AC Common Mode Voltage	–	–	–	15	mV	mV (RMS)
Differential Output Return Loss ¹⁾	SDD22	20	–	–	dB	0.05-0.1 GHz
		10	–	–	dB	0.1-7.5 GHz
		–	–	–		7.5-15 GHz
Common Mode Output Return Loss ²⁾	SCC22	6	–	–	dB	0.1-15 GHz

1) Return loss given by equation $SDD22(dB) = 10 - 16.6 \log_{10}(f/7.5)$, with f in GHz.

2) Common mode reference impedance is 25 Ω common mode return loss helps absorb reflections and noise for EMI.

7.7.9.2 USXGMII Receive Characteristics

[Table 57](#) shows the requirements of the USXGMII interface on the MxL86282S.

Table 57 Receive Characteristics of the USXGMII

Parameter	Symbol	Values			Unit	Note / Test Condition
		Min.	Typ.	Max.		
Reference Differential Impedance	Z_d	–	100	–	Ω	–
Termination Mismatch	Z_M	–	–	5	%	–
AC Common Mode Voltage	–	–	–	25	mV	mV (RMS)
Differential Output Return Loss ¹⁾	SDD11	20	–	–	dB	0.05-0.1 GHz
		10	–	–	dB	0.1-7.5 GHz
		–	–	–		7.5-15 GHz
Common Mode Input Return Loss ²⁾	SCC11	6	–	–	dB	0.1-15 GHz
Differential to Common Mode Input Conversion ²⁾	SCD11	12	–	–	dB	0.1-15 GHz

1) Return loss given by equation $SDD11(dB) = 10 - 16.6 \log_{10}(f/7.5)$, with f in GHz.

2) Common mode reference impedance is 25 Ω . SCD11 relates to conversion of differential to common mode and the associated generation of EMI.

7.7.10 Differential Reference Clock Interface

Table 58 describes the CML differential reference clock output.

Table 58 Reference Clock Output Characteristics

Parameter	Symbol	Values			Unit	Note / Test Condition
		Min.	Typ.	Max.		
Reference Clock Frequency	–	-300	–	+300	ppm	–
Clock Rising Edge Rate	t_{rise}	0.62	1	2	V/ns	-150 mv to 150 mv
Clock Falling Edge Rate	t_{fall}	0.62	1	2	V/ns	-150 mv to 150 mv
Peak to Peak Jitter	$t_{ppjitter}$	0.5	1.2	1.7	ps	100 mV power noise on 1.8 V
Clock Duty Cycle	-	45	50	55	%	–
Output Voltage High	-	0.25	0.4	0.5	V	–
Output Voltage Low	-	0	0.05	0.1	V	–
Differential Output Voltage	-	500	–	900	mV	$2 * V_{CLKP} - V_{CLKN} $
Termination	-	45	–	60	Ω	

7.7.11 Crystal Specification

The 25 MHz crystal must follow the specification given in [Table 59](#).

Table 59 Specification of the Crystal

Parameter	Symbol	Values			Unit	Note / Test Condition
		Min.	Typ.	Max.		
Frequency with 25 MHz Input	f_{clk25}	–	25.0	–	MHz	–
Total Frequency Stability	–	-50	–	+50	ppm	Refers to the sum of all effects: such as general tolerance, aging, and temperature dependency
Series Resonant Resistance	–	–	–	40	Ω	–
Drive Level	–	–	0.1	0.2	mW	–
Load Capacitance	C_L	16	–	26	pF	–
Shunt Capacitance	C_0	–	–	7	pF	–

7.8 External Circuitry

This section specifies the component characteristics of the external circuitry connected to the TPIs of the MxL86282S.

7.8.1 Twisted-Pair Common-Mode Rejection and Termination Circuitry

Figure 33 shows the external circuitry necessary to properly terminate the common mode of the TPI.

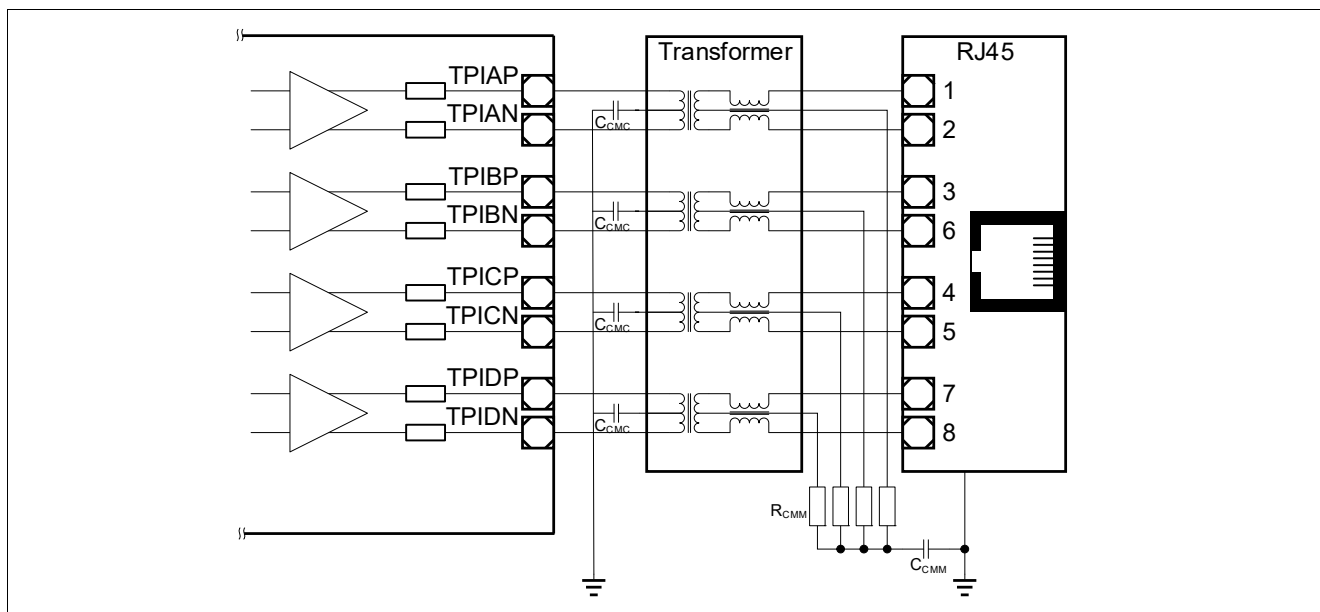

Figure 33 Twisted Pair Common-Mode Rejection and Termination Circuitry

Table 60 defines the component values and their supported tolerances.

Table 60 Electrical Characteristics for Common-Mode Rejection and Termination Circuitry

Parameter	Symbol	Values			Unit	Note / Test Condition
		Min.	Typ.	Max.		
Common-Mode Decoupling Capacitance (Media End)	C_{CMM}	800	1000	1200	pF	±15%, 3 kV
Common-Mode Decoupling Capacitance (Chip End)	C_{CMC}	80	100	120	nF	±15%, 25 V
Common-Mode Termination Resistance (Media End)	R_{CMM}	67.5	75	82.5	Ω	±5%

7.8.2 Transformer (Magnetics)

This section specifies the required electrical characteristics of the transformer¹⁾ devices that are supported. The specifications listed here guarantee proper operation according to IEEE 802.3 [6].

Figure 34 depicts a typical Gigabit Ethernet capable transformer device.

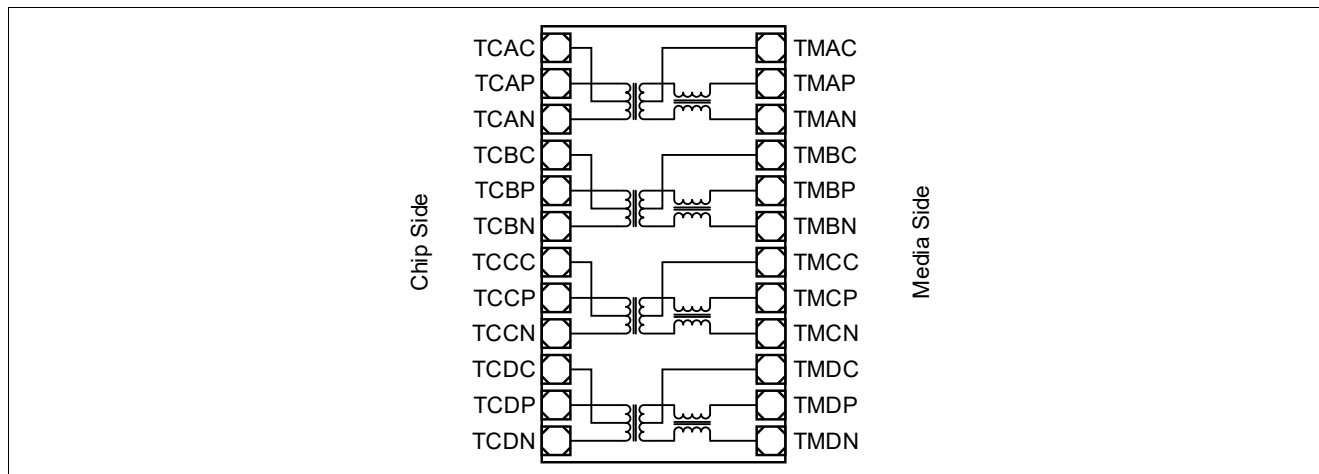

Figure 34 Schematic of an Ethernet Transformer Device

Table 61 lists the characteristics of the supported transformer devices. These characteristics represent the minimum values for achieving standard performance. Since the transformer significantly impacts the link performance, it is possible to increase the loop reach by selecting transformers with improved parameters.

Table 61 Electrical Characteristics for Supported Transformers (Magnetics)

Parameter	Symbol	Values			Unit	Note / Test Condition
		Min.	Typ.	Max.		
Turns Ratio	1:tr	0.95	1.00	1.05		±5%
Differential-to-Common-mode Rejection	DCMR	40	–	–	dB	30 MHz
		35	–	–	dB	60 MHz
		30	–	–	dB	100 MHz
Crosstalk Attenuation	CTA	45	–	–	dB	30 MHz
		40	–	–	dB	60 MHz
		35	–	–	dB	100 MHz
Insertion Loss	IL	–	–	1	dB	1 MHz ≤ f ≤ 250 MHz
Return Loss	RL	16	–	–	dB	1 MHz ≤ f ≤ 40 MHz
Return Loss	RL	16-10*log ₁₀ (f/40)	–	–	dB	40 MHz ≤ f ≤ 250 MHz

1) Also often referred to as magnetics.

7.8.3 RJ45 Plug

Table 62 describes the electrical characteristics of the RJ45 plug to be used in conjunction with MxL86282S.

Table 62 Electrical Characteristics for Supported RJ45 Plugs

Parameter	Symbol	Values			Unit	Note / Test Condition
		Min.	Typ.	Max.		
Crosstalk Attenuation	CTA	45	–	–	dB	30 MHz
		40	–	–	dB	60 MHz
		35	–	–	dB	100 MHz
Insertion Loss	IL	–	–	1	dB	1 MHz ≤ f ≤ 250 MHz
Return Loss	RL	16	–	–	dB	1 MHz ≤ f ≤ 40 MHz
Return Loss	RL	16-10*log ₁₀ (f/40)	–	–	dB	40 MHz ≤ f ≤ 250 MHz

8 Package Outline

The product is assembled in a PG-FCLBGA-277 package, which complies with regulations requiring lead free material. [Table 63](#) lists the parameters generated in accordance with JEDEC JESD51 standards [\[8\]](#).

Table 63 JEDEC Thermal Resistance Package Parameter - Compact 2-R Model Network

Item	Name/Value
Thermal Resistance - Junction to Case Top	$R_{th, Jctop} = 0.082 \text{ K/W}$
Minimum Thermal Resistance - Junction to 0 mm from package edge on PCB	$R_{th, JB} = 2.70 \text{ K/W}$

Table 64 Stress Force Package Parameter

Item	Value
Force	1.939 kg
Pressure	1.346528 kg/cm ²
	19.15207 PSI

Figure 35 shows the mechanical drawings for this package. The dimensions are in millimeters.

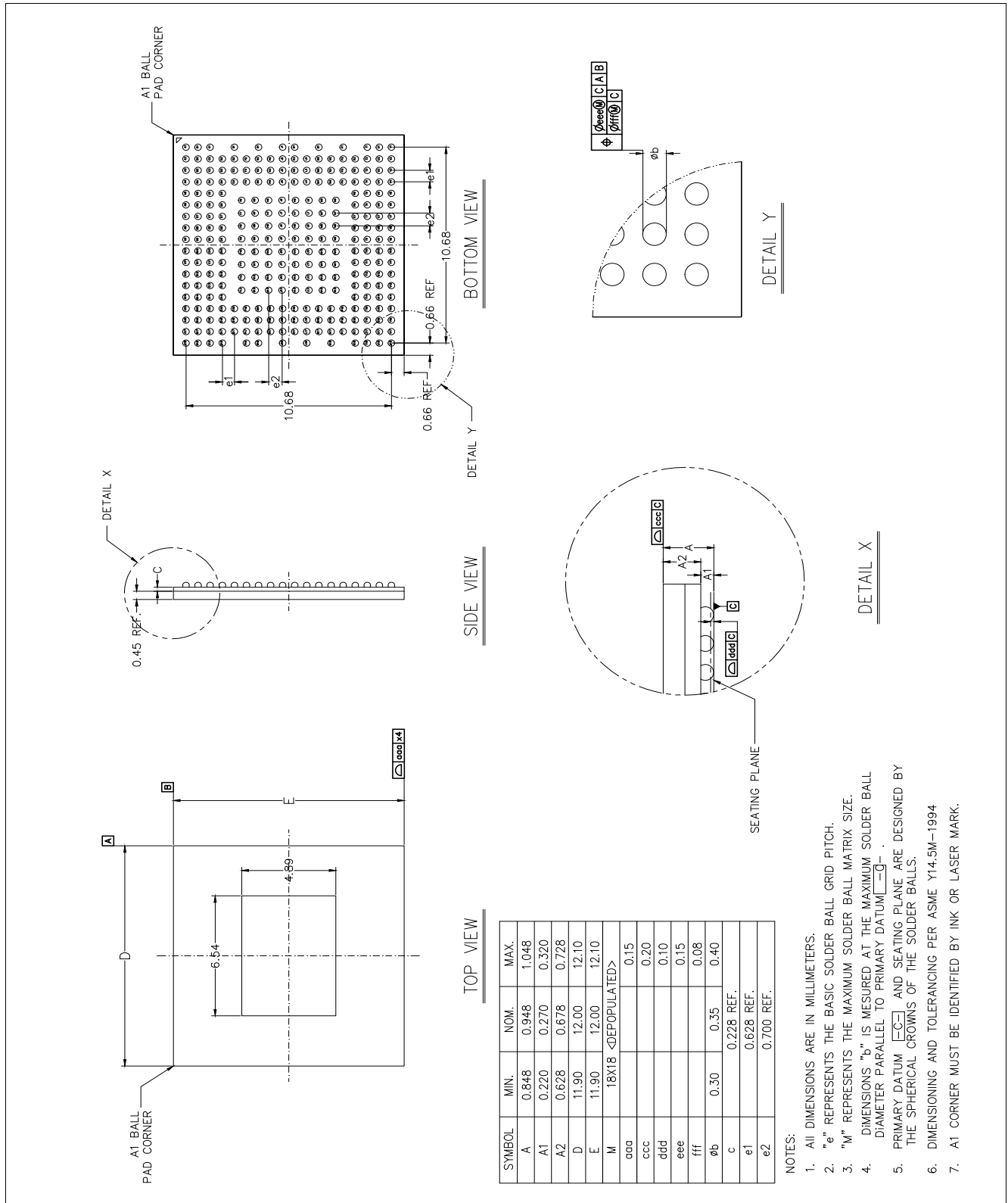

Figure 35 PG-FCLBGA-277 12 mm x 12 mm Package Outline

9 Product Ordering Information

Table 65 provides the product ordering information.

Table 65 Product and Package Naming

Marketing Part Number	Ordering Part Number	Shipping Format	Package	Device Number ¹⁾	Device Revision Number ²⁾	PHY Identifier ³⁾
MxL86282S	MXL86282S-ABE-T	Tray	PG-FCLBGA-277	0x10	0x0	0x5500

1) LDN field in CL22 and CL45 registers.

2) LDRN field in CL22 and CL45 registers.

3) PHY Identifier 2 register 16-bit value.

Note: For more information about part numbers, as well as the most up-to-date information and additional information on environmental rating, go to <https://www.maxlinear.com/products/interface/ethernet>.

Literature References

- [1] Ethernet Switch MxL86282C Data Sheet Rev 1.6
- [2] Ethernet Switch MxL862xxI MxL862xxS Web-Smart Switch Configuration User Guide Rev. 1.0
- [3] Ethernet Switch MxL86252I MxL86252S MxL86282I MxL86282S Web-Smart WebGUI User Guide Rev. 1.0
- [4] Ethernet Switch MxL862xxI MxL862xxS Light-Smart and Web-Smart WebGUI Customization Application Note Rev. 1.0
- [5] Ethernet Switch MxL862xx Unmanaged and Managed-Attached Configuration User Guide Rev. 1.0

Attention: Refer to the latest revisions of the documents.

Standards References

- [6] IEEE 802.3-2022: Carrier Sense Multiple Access with Collision Detection (CSMA/CD) Access Method and Physical Layer Specifications, IEEE Computer Society, May 2022
<https://standards.ieee.org/ieee/802.3/10422/>
- [7] Serial-GMII Specification: Revision 1.8, Cisco Systems, April 2005
<https://archive.org/details/sgmii>
- [8] JEDEC standard, JESD 51: Methodology for the Thermal Measurement of Component Packages (Single Semiconductor Device), December 1995
<https://www.jedec.org/standards-documents/docs/jesd-51>
- [9] Universal SXGMII Interface for a Single MultiGigabit Copper Network Port, Revision 2.4, Cisco Systems, July 30th 2019
- [10] Cisco USXGMII Multiport Copper PHY Specification, EDCS-1517762, Version 2.15, May 11th, 2017
- [11] Cisco USXGMII Single-port Copper PHY Specification, EDCS-1150953, Version 2.4, May 23rd 2016
- [12] The I2C-Bus Specification Version 2.1, January 2000
- [13] Negotiated Fast Retrain, Revision 2.0, Cisco Systems, June 10th, 2011
- [14] Microsoft Security Development Lifecycle
<https://www.microsoft.com/en-us/securityengineering/sdl/practices>

Terminology

A

ADS	Auto-Downspeed
AFE	Analog Front End
ANEG	Auto-Negotiation
ANSI	American National Standards Institute
ASP	Analog Signal Processing

B

BW	Bandwidth
----	-----------

C

Cat 5	Category 5 Cabling
CDB	Clock Distribution Block
CDR	Clock and Data Recovery
CML	Current Mode Logic

D

DSP	Digital Signal Processing
DWRR	Deficit Weighted Round Robin

E

EEE	Energy-Efficient Ethernet
EEPROM	Electrically Erasable Programmable ROM
EMI	Electromagnetic Interference
ESD	Electrostatic Discharge

F

FCA	Flash Configuration Area
FCS	Frame Check Sequence
FLP	Fast Link Pulse

G

GMII	Gigabit Media-Independent Interface
GPIO	General Purpose Input/Output

H

HBM	Human Body Model
-----	------------------

I

I ² C	Internally Integrated Circuit Interface (also I2C)
IC	Integrated Circuit
IEEE	Institute of Electrical and Electronics Engineers

J

JTAG	Joined Test Action Group
------	--------------------------

L

LAG	Link Aggregation Group
-----	------------------------

LAN	Local Area Network
LED	Light Emitting Diode
LJPLL	Low Jitter Phase-Locked Loop
LPI	Low Power Idle
LSB	Least Significant Bit
M	
MAC	Media Access Controller
MDI	Media-Dependent Interface
MDIO	Management Data Input/Output
MDIX	Media-Dependent Interface Crossover
MMD	MDIO Manageable Device
MSB	Most Significant Bit
N	
NLP	Normal Link Pulse
O	
OSI	Open Systems Interconnection
OUI	Organizationally Unique Identifier
P	
PCB	Printed Circuit Board
PCS	Physical Coding Sublayer
PD	Power Down
PFC	Priority Flow Control
PHY	Physical Layer (device)
PLL	Phase-Locked Loop
PMA	Physical Media Attachment
Q	
QSPI	Quad Serial Peripheral Interface
R	
Rx	Receive
S	
SerDes	Serializer-Deserializer
SFP	Small Form-Factor Pluggable
SMD	Surface Mounted Device
SoC	System on Chip
SP	Strict Priority
STA	Station Management Entity (MAC SoC)
SVN	Security Version Number
T	
TLE	Transformerless Ethernet
TPG	Test Packet Generator

TPI	Twisted Pair Interface
Tx	Transmit
U	
USXGMII	Universal Serial Multi(x) Gigabit Media Independent Interface
W	
WoL	Wake-on-LAN
WRED	Weighted Random Early Detection
WSP	Web-Smart Processor
X	
XO	Crystal Oscillator