

XCMH2102L1

XCMH Limit Switches Miniature Plastic Metal Roller Plunger NC + NO Snap L1



Main

Range of Product	Telemecanique Limit switches XC Standard
Series name	Standard format
Product or Component Type	Limit switch
Device short name	XCMH
Sensor design	Miniature
Body type	Fixed
Head type	Plunger head
Material	Plastic
Body Material	Plastic
Head material	Zamak
Fixing Mode	By the body
Movement of operating head	Linear
Type of operator	Spring return roller plunger metal
Type of approach	Lateral approach, 2 directions
Number of poles	2
Contacts type and composition	1 NC + 1 NO
Contact operation	Snap action

Complementary

Switch actuation	By 30° cam
Electrical connection	Fixed cable
Cable length	3.28 ft (1 m)
Cable composition	4 x 0.34 mm ²
Wire insulation material	PvR
Contacts insulation form	Zb
Positive opening	With
Positive opening minimum force	35 N
Minimum force for tripping	7 N
Maximum actuation speed	1.64 ft/s (0.5 m/s)
Contact code designation	C300, AC-15 (Ue = 240 V), Ie = 0.75 A EN/IEC 60947-5-1 appendix A R300, DC-13 (Ue = 250 V), Ie = 0.1 A EN/IEC 60947-5-1 appendix A
[Ui] rated insulation voltage	300 V 3)UL 508 300 V 3)IEC 60947-5-1 300 V 3)CSA C22.2 No 14
Maximum resistance across terminals	25 MOhm IEC 60255-7 category 3
[Uimp] rated impulse withstand voltage	4 KV IEC 60664 4 kV IEC 60947-1
Short-circuit protection	6 A cartridge fuse gG
Electrical durability	5000000 Cycles, DC-13, 120 V, 1 W 60 cyc/mn 0.5 IEC 60947-5-1 appendix C 5000000 Cycles, DC-13, 24 V, 3 W 60 cyc/mn 0.5 IEC 60947-5-1 appendix C 5000000 cycles, DC-13, 48 V, 2 W 60 cyc/mn 0.5 IEC 60947-5-1 appendix C
Mechanical durability	5000000 cycles
Width	1.18 in (30 mm)
Height	2.77 in (70.4 mm)
Depth	0.63 in (16 mm)
Net Weight	0.18 lb(US) (0.08 kg)

The information provided in this documentation contains general descriptions and/or technical characteristics of the performance of the products contained herein. This documentation is not intended as a substitute for and is not to be used for determining suitability or reliability of these products for specific user applications. It is the duty of any such user or integrator to perform the appropriate and complete risk analysis, evaluation and testing of the products with respect to the relevant specific application or use thereof. Neither Schneider Electric Industries SAS nor any of its affiliates or subsidiaries shall be responsible or liable for misuse of the information contained herein.

Environment

Shock resistance	25 gn 18 ms IEC 60068-2-27
Vibration resistance	5 gn 10...500 Hz)IEC 60068-2-6
IP degree of protection	IP66 conforming to IEC 60529 IP67 conforming to IEC 60529
IK degree of protection	IK04 EN 50102
Electrical shock protection class	Class II IEC 61140 Class II NF C 20-030
Ambient Air Temperature for Operation	-13...158 °F (-25...70 °C)
Ambient Air Temperature for Storage	-40...158 °F (-40...70 °C)
Protective treatment	TC
Product Certifications	CSA CCC UL
Standards	CSA C22.2 No 14 UL 508 EN/IEC 60204-1 EN/IEC 60947-5-1



Ordering and shipping details

Category	22413-LIMIT SWITCH, IEC, MINIATURE
Discount Schedule	T
GTIN	3389119650977
Returnability	Yes

Packing Units

Unit Type of Package 1	PCE
Number of Units in Package 1	1
Package 1 Height	0.63 in (1.6 cm)
Package 1 Width	7.87 in (20 cm)
Package 1 Length	9.84 in (25 cm)
Package 1 Weight	2.47 oz (70 g)
Unit Type of Package 2	S02
Number of Units in Package 2	30
Package 2 Height	5.91 in (15 cm)
Package 2 Width	11.81 in (30 cm)
Package 2 Length	15.75 in (40 cm)
Package 2 Weight	8.58 lb(US) (3.894 kg)

Offer Sustainability

California proposition 65	WARNING: This product can expose you to chemicals including: Diisononyl phthalate (DINP), which is known to the State of California to cause cancer, and Di-isodecyl phthalate (DIDP), which is known to the State of California to cause birth defects or other reproductive harm. For more information go to www.P65Warnings.ca.gov
REACH Regulation	 REACH Declaration
EU RoHS Directive	Pro-active compliance (Product out of EU RoHS legal scope)  EU RoHS Declaration
Mercury free	Yes
RoHS exemption information	 Yes
WEEE	The product must be disposed on European Union markets following specific waste collection and never end up in rubbish bins.

Contractual warranty

Warranty	18 months
----------	-----------

Dimensions

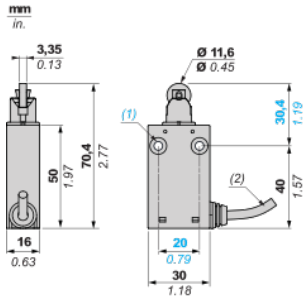

- (1) 2 fixing holes Ø 4.2 mm (0.16 in.), counterbored Ø 8 mm by 4 mm deep (counterbored Ø 0.32 in. by 0.16 in. deep).
- (2) Cable external diameter: 4.2 mm (0.16 in.)

Mounting and Clearance

Mounting: distance required for connection

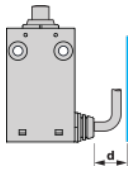

d : min.15 mm/min.0.59 in.

Sweep of Connecting Cable

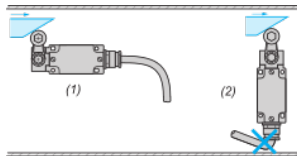

(1) : Recommended

(2) : To be avoided

Mounting with Spacers

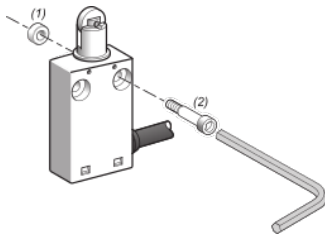

(1) : 2 spacers supplied with the switch

(2) : 2 screws Ø 4mm (not included)

Wiring diagram

2-pole NC + NO snap action

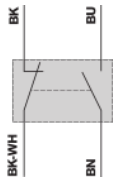

(BK) Black

(BK-WH) Black White

(BN) Brown

(BU) Blue

Characteristics of Actuation

Switch Actuation by 30° Cam

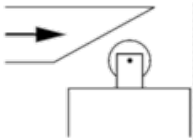

Functional Diagram

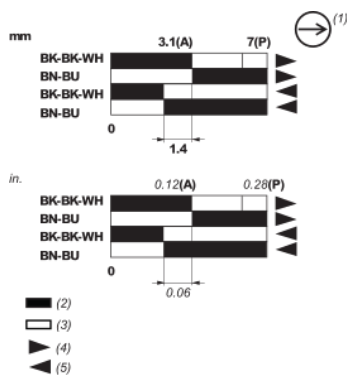

(P) Positive opening point

(A) Cam displacement

(1) NC contact with positive opening operation

(2) Closed

(3) Open

(4) Tripping

(5) Resetting

(BK) Black

(BK-WH) Black White

(BN) Brown

(BU) Blue