

24x4 DOTS MATRIX LED DRIVER EVALUATION BOARD GUIDE

DESCRIPTION

IS31FL3748 is an LED driver with 24 high voltage (24V) constant current channels. It can support from one to four power scan to become a 24xn matrix LED driver, where n= 1 to 4. Each channel/dot can be pulse width modulated (PWM) with 7-bit/8-bit precision for smooth LED brightness control. In addition, each channel/dot can be controlled by a 7-bit/8-bit output current control register, which allows fine tuning the current for rich RGB color mixing, e.g., a pure white color LED application. The maximum output current of each channel is designed to be 40mA, which can be adjusted by 3 7-bit/8-bit global control registers (one group for R for channels 3xI, one group for G for channels 3xI+1, and one group for B for channels 3xI+2, where I= 0 to 7). Proprietary algorithms are used in IS31FL3748 to minimize power bus noise caused by passive components on the power bus such as MLCC decoupling capacitor. All registers can be programmed via HSB (high speed Series Bus, up to 10MHz), DSB (Manchester encoded, daisy chained serial bus, up to 2MHz), I2C (1MHz) or SPI (12MHz) bus.

IS31FL3748 can be turned off with minimum current consumption by either pulling the SDB pin low or by using the software shutdown feature. It internally generates 4.8V V_{OUT} to power the internal logic operation, which can also be external powered from 3V to 5.5V.

IS31FL3748 is available in QFN48 (6mmx6mm) package and can work over temperature range from -40°C to +125°C.

QUICK START

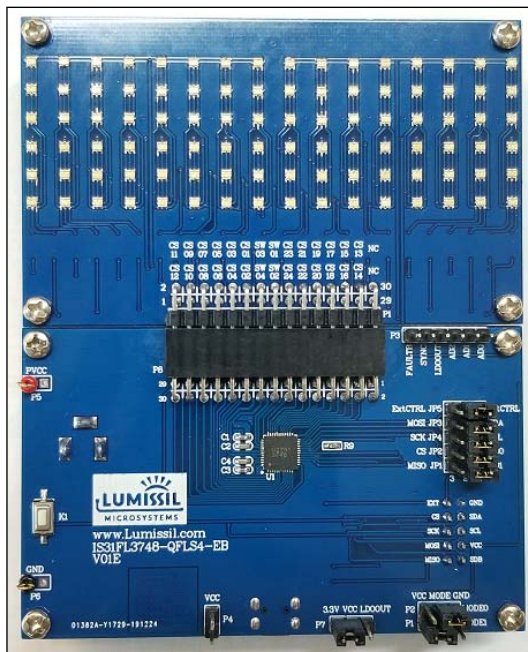

Figure 1 Photo of IS31FL3748 Evaluation Board

FEATURES

- Support 24 constant current channels @ 40mA/ch
- 4 PMOS high side switches (500mA, 5Ω each); when combining 2 for 2x24 configuration, supporting 1A each
- Tolerate up to 30V, nominal operation voltage between 4.5V to 24V
- Built-in LDO to generate 4.8V supply for internal logic (option to float it and use external power)
- Interface
 - DSB (Daisy Chained Serial Bus: 2MHz)
 - HSB (High Speed Series Bus: 10MHz)
 - I2C (1MHz)
 - SPI (12MHz)
- SDB pin rising edge reset the interface
- Reset register reset all the registers to default value
- For DSB and HSB
 - Built-in PWM generator: 7-bit/dot
 - Built-in Dot correction: 7-bit/dot
 - 7-bit x 3 global current adjustment
- For I2C and SPI
 - Built-in PWM generator: 8-bit/dot
 - Built-in Dot correction: 8-bit/dot
 - 8-bit x 3 global current adjustment
- 4 groups delay to minimize the power ripple
- Channel to channel timing skew (one sys-clock skew to reduce transient noise)
- Power noise reduction method
- Spread spectrum
- LED open/short detection and fault reporting (For I2C and SPI only)
- Other protection: over temperature, over voltage, under voltage
- FAULT/bidirectional: one fail, all fail optional supported (can be turned on/off by interface bus)
- Operating temperature: -40°C to +125°C
- QFN-48 (6mmx6mm) package
- RoHS & Halogen-Free Compliance
- TSCA Compliance

RECOMMENDED EQUIPMENT

- 12V, ≥1A power supply

ABSOLUTE MAXIMUM RATINGS

- V_{IN+} , ≤15V power supply

Caution: EVB is designed for 12V application, higher than 12V will cause extra-heat on the IC and if V_{IN} (P5 or CON2) is higher than 15V, the IS31FL3748 will be too hot and enter thermal shutdown mode, if V_{IN} (P5 or CON2) exceeds the conditions listed above, the board may be damaged.

24x4 DOTS MATRIX LED DRIVER EVALUATION BOARD GUIDE

PROCEDURE

The IS31FL3748 evaluation board is fully assembled and tested. Follow the steps listed below to verify board operation.

Caution: Do not turn on the power supply until all connections are completed.

- 1) Connect the ground terminal of the power supply to the GND and the positive terminal to the P5 (PVCC), or connect the DC power to the connector (CON2).
- 2) Connect '1' and '2' in JP5 (Internal Control) to enable the control of board MCU (default status).
- 3) Connect 'VCC' and 'LDOOUT' in P7
- 4) I2C MODE (default mode):
Connect '1' and '2' in JP3 (SDA) / JP4 (SCL) / JP2 (AD0) / JP1 (AD1).
Connect 'VCC' and 'MODE' in P1.
Connect 'GND' and 'MODE' in P2.
- 5) SPI MODE:
Connect '3' and '2' in JP3 (MOSI) / JP4 (SCK) / JP2 (CS) / JP1 (MISO).
Connect 'VCC' and 'MODE' in P2 and P1.
- 6) DSB MODE:
Connect '3' and '2' in JP3 (MOSI).
Connect '1' and '2' in JP2 (AD0) / JP1 (AD1).
Connect 'VCC' and 'MODE' in P2.
Connect 'GND' and 'MODE' in P1.
- 7) HSB MODE:
Connect '3' and '2' in JP3 (MOSI) / JP4 (SCK).
Connect '1' and '2' in JP2 (AD0) / JP1 (AD1).
Connect 'GND' and 'MODE' in P2 and P1.
- 8) Turn on the power supply and pay attention to the supply current. If the current exceeds 1A, please check for circuit fault.
- 9) Enter the desired mode of display by toggling the MODE button (K1)

ORDERING INFORMATION

Part No.	Temperature Range	Package
IS31FL3748-QFLS4-EB	-40°C to +125°C (Industrial)	QFN-48, Lead-free

Table 1 Ordering Information

For pricing, delivery, and ordering information, please contacts Lumissil's analog marketing team at analog@lumissil.com or (408) 969-6600

EVALUATION BOARD OPERATION

The IS31FL3748 evaluation board has 5 display modes. Press MODE button (K1) to switch configurations.

- 1) (Default mode) Rainbow
- 2) Red
- 3) Green
- 4) Blue
- 5) White

Note: IS31FL3748 solely controls the FxLED function on the evaluation board.

SOFTWARE SUPPORT

JP5 default setting is 'IntCTRL' (Internal Control). If it is set to 'ExtCTRL' (External Control), the on-board MCU will configure all the IO pins to high impedance mode and enter sleep mode. The I2C pins and SDB pin are also set to High Impedance. External I2C and SDB signals can be connected to TP1 to control the IS31FL3748 LED driver.

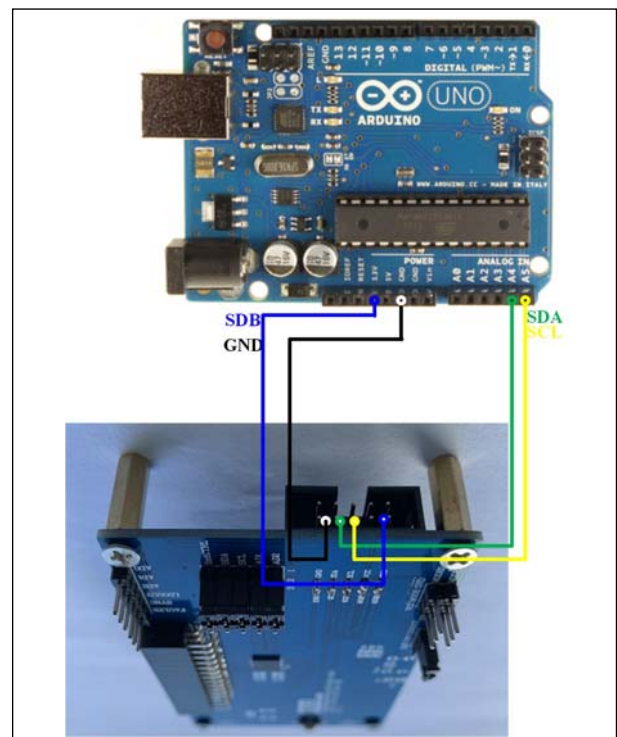

Figure 2 Arduino UNO connected to Evaluation Board

24x4 DOTS MATRIX LED DRIVER EVALUATION BOARD GUIDE

The steps listed below are an example using the Arduino for external control.

The Arduino hardware consists of an Atmel microcontroller with a bootloader allowing quick firmware updates. First download the latest Arduino Integrated Development Environment IDE (1.6.12 or greater) from www.arduino.cc/en/Main/Software. Also download the Wire.h library from www.arduino.cc/en/reference/wire and verify that pgmspace.h is in the directory ...program Files(x86)/Arduino/hardware/tools/avr/avr/include/avr/. Then download the latest IS31FL3748 test firmware (sketch) from the ISSI website <http://ams.issi.com/US/product-analog-fxled-driver.shtml>

- 1) Open '1' and '2' and short '2' and '3' of JP5 to set to 'ExtCTRL' (External Control).
- 2) Connect 5 pins from Arduino board to IS31FL3748 EVB:
 - a) Arduino GND to IS31FL3748 EVB GND.
 - b) Arduino SCL (A5) to IS31FL3748 EVB SCL.
 - c) Arduino SDA (A4) to IS31FL3748 EVB SDA.
 - d) If Arduino use 3.3V MCU VCC, connect 3.3V to IS31FL3748 EVB SDB, if Arduino use 5.0V MCU VCC, connect 5.0V to EVB SDB. (Arduino UNO's VCC (VOH) is 5.0V, so SDB=5.0V)
- 3) Run the Arduino code for desired mode setting by Arduino code.

Please refer to the datasheet to get more information about IS31FL3748.

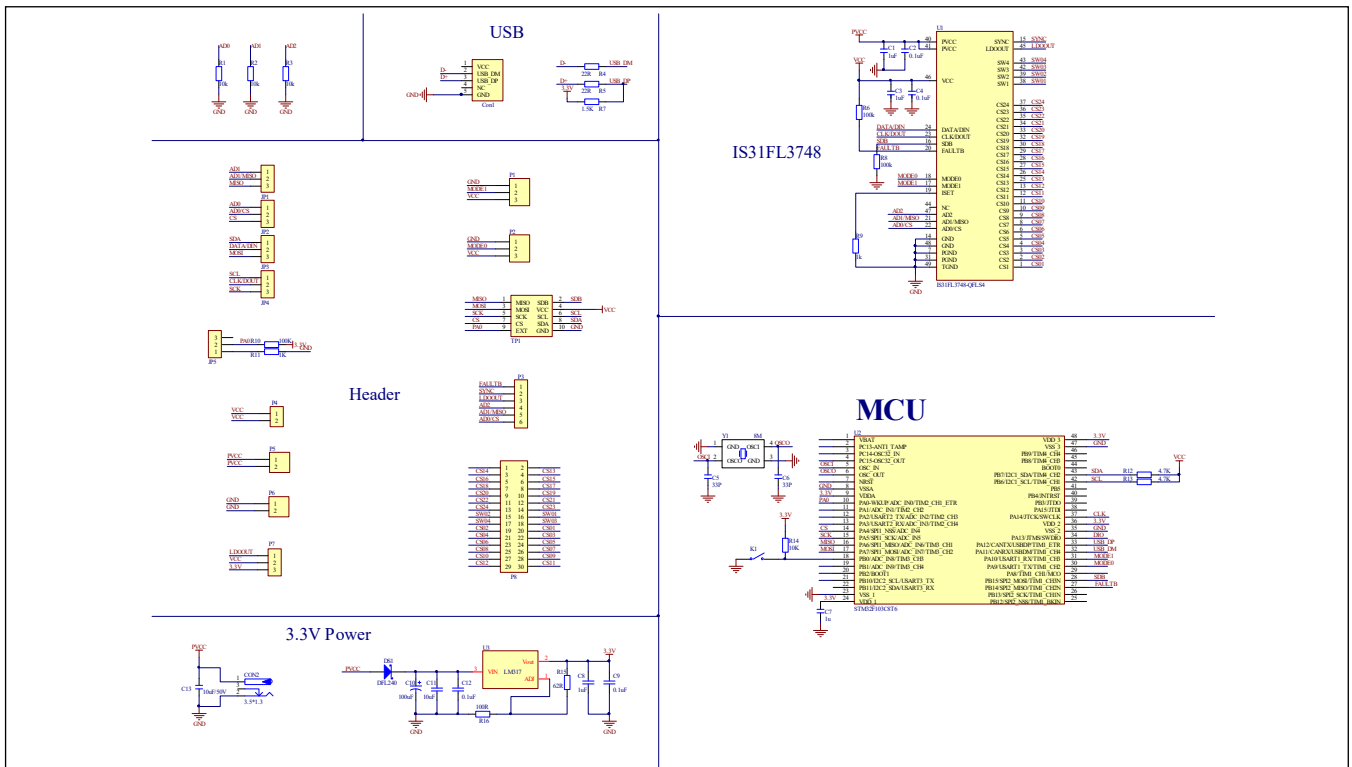
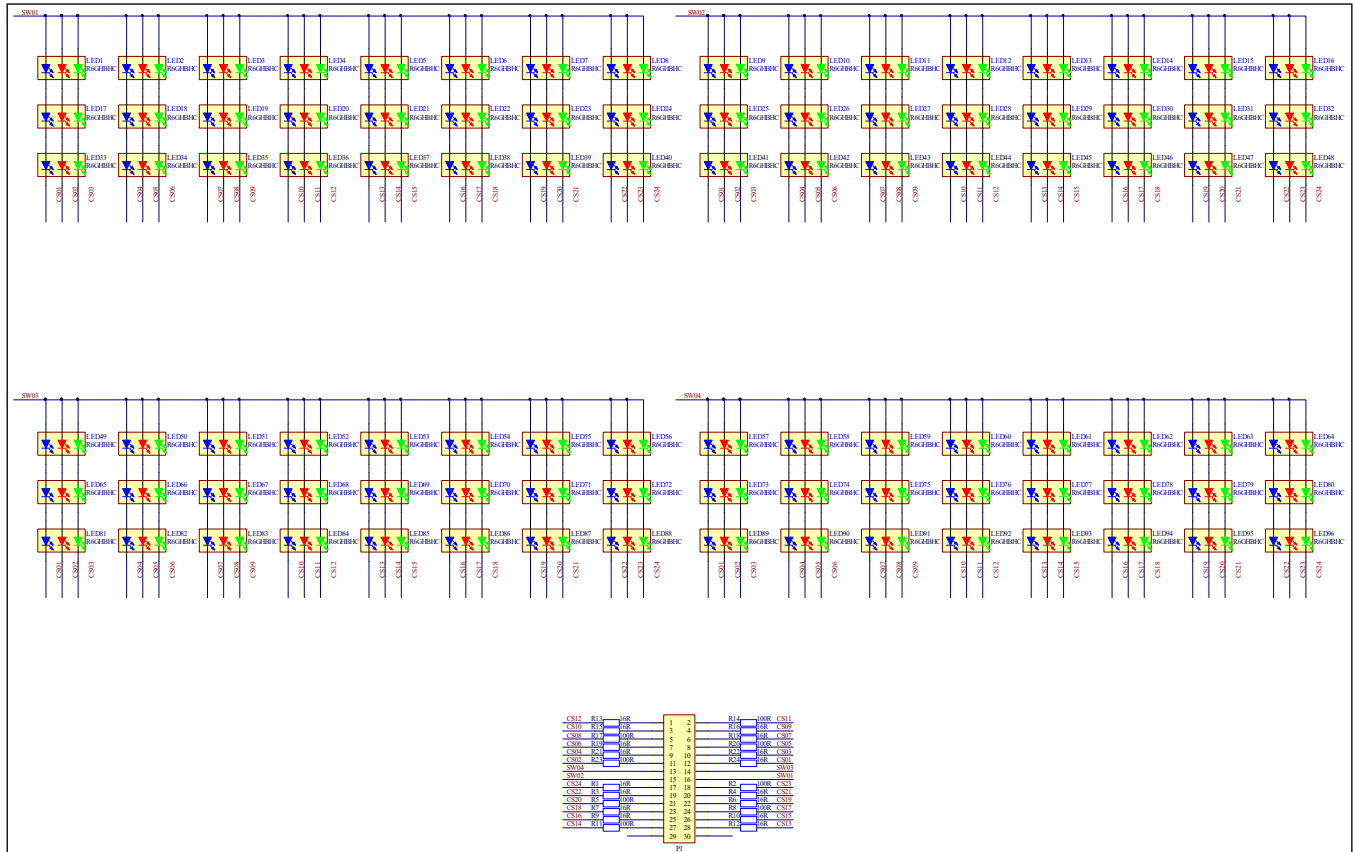

Figure 3 IS31FL3748 EVB Schematic

24x4 DOTS MATRIX LED DRIVER EVALUATION BOARD GUIDE



BILL OF MATERIALS

Name	Symbol	Description	Qty	Supplier	Part No.
LED Driver	U1	Matrix LED Driver	1	LUMISSIL	IS31FL3748
MCU	U2	Microcontroller	1	STM	STM32F103C8T6
LDO	U3	Low-dropout Regulator	1	ONSEMI	LM317
Crystal	Y1	Crystal, 8MHz	1	JB	HC-49S
Diode	DS1	Diode, SMD	1	DIODES	DFLS240
Resistor	R1,R2,R3,R14	RES,10k,1/10W,±5%,SMD	4	Yageo	RC0603JR-0710KL
Resistor	R15	RES,62R,1/10W,±5%,SMD	1	Yageo	RC0603JR-07130RL
Resistor	R7	RES,1.5k,1/10W,±5%,SMD	2	Yageo	RC0603JR-072KL
Resistor	R16	RES,100R,1/10W,±5%,SMD	1	Yageo	RC0603JR-07390RL
Resistor	R6,R8,R10	RES,100k,1/10W,±5%,SMD	3	Yageo	RC0603JR-07100KL
Resistor	R12,R13	RES,4.7k,1/10W,±5%,SMD	2	Yageo	RC0603JR-074K7L
Resistor	R9,R11	RES,1k,1/10W,±5%,SMD	2	Yageo	RC0603JR-071KL
Resistor	R4,R5	RES,22R,1/10W,±5%,SMD	2	Yageo	RC0603JR-0722RL
Capacitor	C5,C6	CAP,33pF,50V,±5%,SMD	2	Yageo	CQ0603JRNPO9BN330
Capacitor	C13	CAP,10µF,16V,±20%,SMD	1	Yageo	CC0603MRX5R7BB106
Capacitor	C2,C4,C9	CAP,100nF,16V,±20%,SMD	3	Yageo	CC0603MRX7R7BB104
Capacitor	C10	CAP,100µF,35V,±20%,SMD	1	Lelon	VEU101M1VTR-0810
Capacitor	C11,C13	CAP,10µF, 50V,±10%,SMD	2	Yageo	CC1206KKX5R9BB106
Capacitor	C12	CAP,100nF,25V,±10%,SMD	1	Yageo	AC1206KRX7R8BB104
Capacitor	C8	CAP,1µF,16V,±10%,SMD	1	Yageo	AC0805KFX7R7BB105
Capacitor	C1,C3,C7	CAP,1µF,16V,±10%,SMD	2	Yageo	CC0603KRX7R7BB105
Button	K1	Button, SMD	1		

Bill of Materials, refer to Figure 3 above.

BILL OF MATERIALS

Name	Symbol	Description	Qty	Supplier	Part No.
LED	LED1~LED96	RGB LED	96	EVERLIGHT	19-337/R6GHBHC-A01/2T
Resistor	R1,R3,R4...	RES,16R,1/4W,±5%,SMD	16	Yageo	RC1206JR-0716RL
Resistor	R2,R5,R8...	RES,100R,1/4W,±5%,SMD	8	Yageo	RC1206JR-07100RL

Bill of Materials, refer to Figure 4 above.

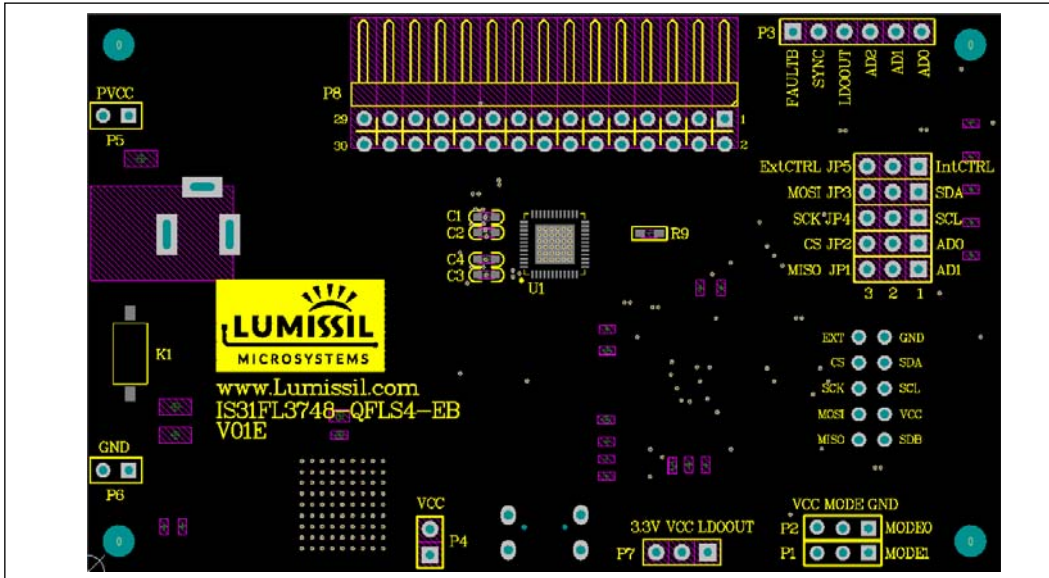

Figure 5 Board Component Placement Guide - Top Layer

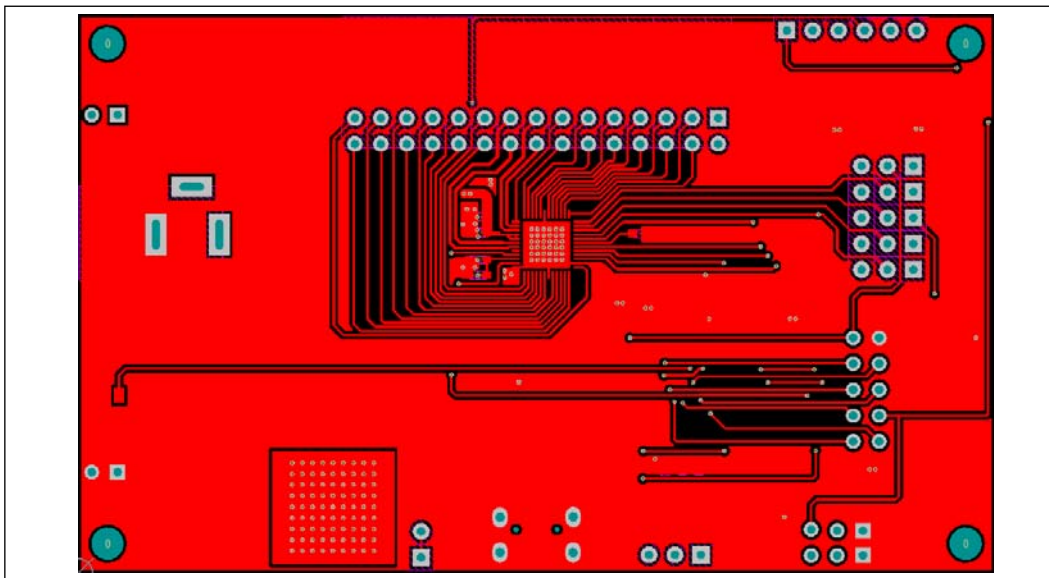

Figure 6 Board PCB Layout - Top Layer

24x4 DOTS MATRIX LED DRIVER EVALUATION BOARD GUIDE

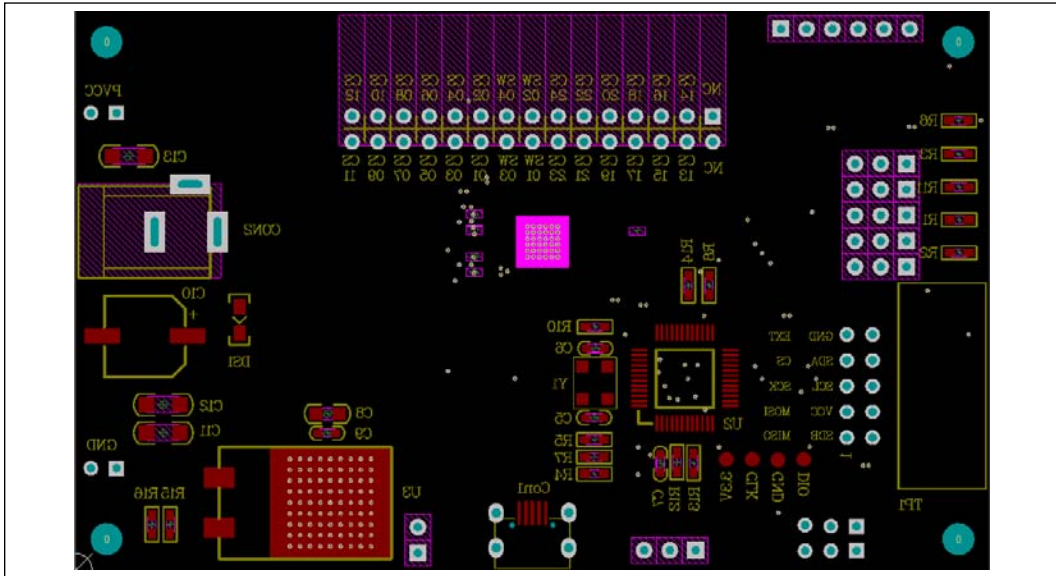

Figure 7 Board Component Placement Guide - Bottom Layer

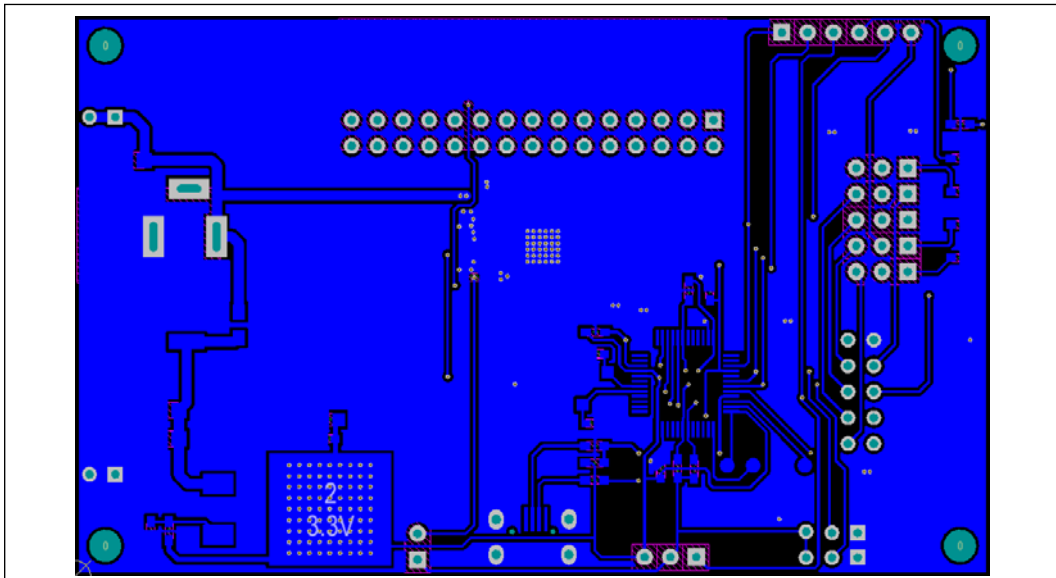

Figure 8 Board PCB Layout - Bottom Layer

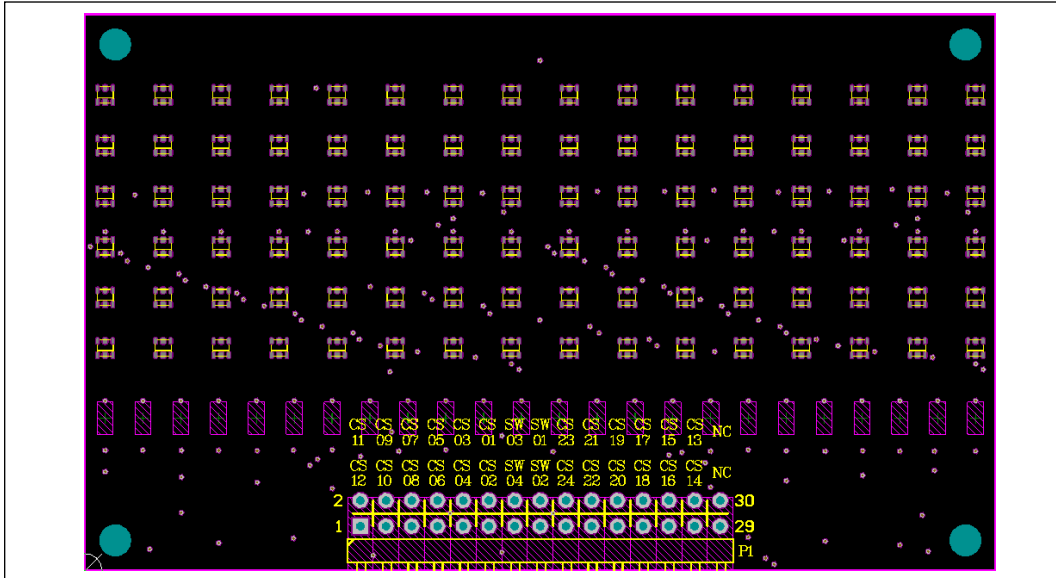

Figure 9 Board Component Placement Guide - Bottom Layer

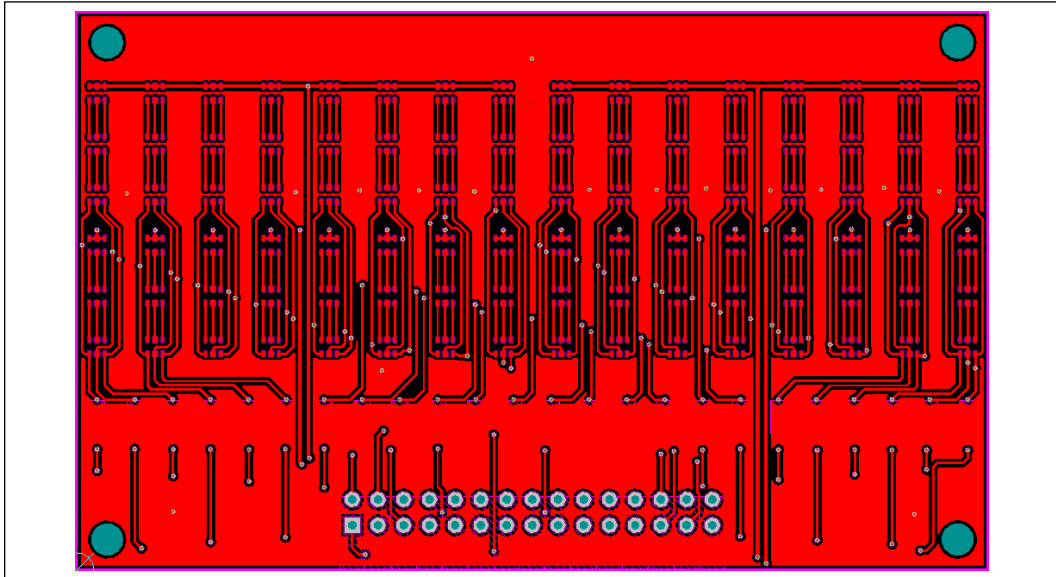

Figure 10 Board PCB Layout - Bottom Layer

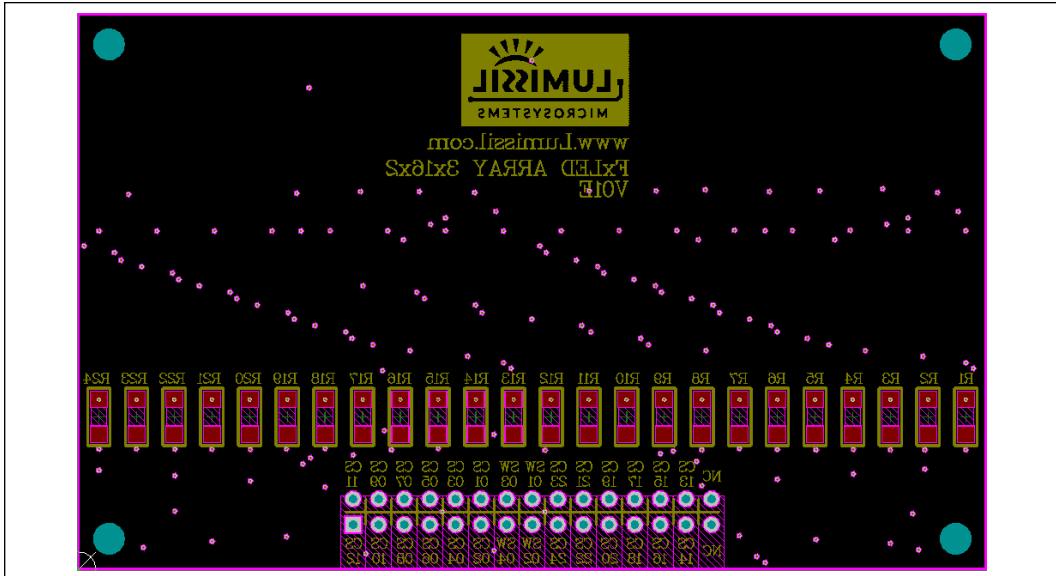

Figure 11 Board Component Placement Guide - Bottom Layer

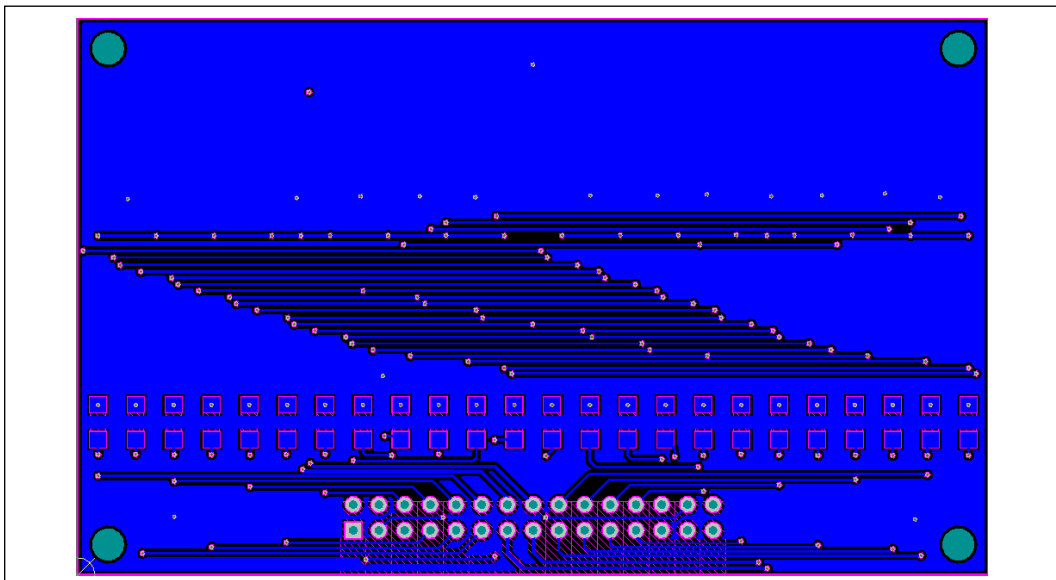

Figure 12 Board PCB Layout - Bottom Layer

Copyright © 2024 Lumissil Microsystems. All rights reserved. Lumissil Microsystems reserves the right to make changes to this specification and its products at any time without notice. Lumissil Microsystems assumes no liability arising out of the application or use of any information, products or services described herein. Customers are advised to obtain the latest version of this device specification before relying on any published information and before placing orders for products.

Lumissil Microsystems does not recommend the use of any of its products in life support applications where the failure or malfunction of the product can reasonably be expected to cause failure of the life support system or to significantly affect its safety or effectiveness. Products are not authorized for use in such applications unless Lumissil Microsystems receives written assurance to its satisfaction, that:

- a.) the risk of injury or damage has been minimized;
- b.) the user assume all such risks; and
- c.) potential liability of Lumissil Microsystems is adequately protected under the circumstances

REVISION HISTORY

Revision	Detail Information	Data
A	Initial Release	2019.10.14
B	Modify FxLED ARRAY 3x16x2 and Update Figures	2021.11.04
C	Update to new Lumissil logo and add RoHS	2024.12.10

APPENDIX I : IS31FL3748 Arduino Test Code V01A

```

#include<Wire.h>
#include<avr/pgmspace.h>
#define Addr_GND 0x80

byte PWM_Gamma64[64]=
{
  0x00,0x01,0x02,0x03,0x04,0x05,0x06,0x07,
  0x08,0x09,0x0b,0x0d,0x0f,0x11,0x13,0x16,
  0x1a,0x1c,0x1d,0x1f,0x22,0x25,0x28,0x2e,
  0x34,0x38,0x3c,0x40,0x44,0x48,0x4b,0x4f,
  0x55,0x5a,0x5f,0x64,0x69,0x6d,0x72,0x77,
  0x7d,0x80,0x88,0x8d,0x94,0x9a,0xa0,0xa7,
  0xac,0xb0,0xb9,0xbf,0xc6,0xcb,0xcf,0xd6,
  0xe1,0xe9,0xed,0xf1,0xf6,0xfa,0xfe,0xff
};

void setup()
{
  Wire.begin();
  Wire.setClock(400000);//I2C 400kHz
  pinMode(4,OUTPUT);//SDB
  digitalWrite(4,HIGH);//SDB_HIGH
  Init3748();
}

void loop() {
  // put your main code here, to run repeatedly:
  mainloop();
}

void IS_IIC_WriteByte(uint8_t Dev_Add,uint8_t Reg_Add,uint8_t Reg_Dat)
{
  Wire.beginTransmission(Dev_Add/2);
  Wire.write(Reg_Add); // sends regaddress
  Wire.write(Reg_Dat); // sends regaddress
  Wire.endTransmission(); // stop transmitting
}

void Init3748(void)
{
  int i;
  IS_IIC_WriteByte(Addr_GND,0x7E,0xC6);//unlock
  IS_IIC_WriteByte(Addr_GND,0x7A,0x6E);//choose page
  IS_IIC_WriteByte(Addr_GND,0x02,0x02);//normal operation
  IS_IIC_WriteByte(Addr_GND,0x04,0xFF);//GCC
  IS_IIC_WriteByte(Addr_GND,0x06,0xFF);//GCC
  IS_IIC_WriteByte(Addr_GND,0x08,0xFF);//GCC

  for(i=0x56; i<=0x5C; i=i+2)
  {
    IS_IIC_WriteByte(Addr_GND,0x7E,0xC6);//unlock
    IS_IIC_WriteByte(Addr_GND,0x7A,i);//choose page
    IS_IIC_WriteByte(Addr_GND,0x40,0x00);//PWM all channel selected
  }
  IS_IIC_WriteByte(Addr_GND,0x81,0x00);//update

  for(i=0x66; i<=0x6C; i=i+2)
  {
    IS_IIC_WriteByte(Addr_GND,0x7E,0xC6);//unlock
    IS_IIC_WriteByte(Addr_GND,0x7A,i);//choose page
    IS_IIC_WriteByte(Addr_GND,0x40,0xFF);//SL all channel selected
  }
}

void mainloop(void)//
{
  int i,j,k;

```

```

for(j=0;j<63;j++)
{
  for(k=0x56;k<=0x5C;k=k+2)
  {
    IS_IIC_WriteByte(Addr_GND,0x7E,0xC6);//unlock
    IS_IIC_WriteByte(Addr_GND,0x7A,k);//choose page
    for(i=0x02;i<0x31;i=i+6)
    {
      IS_IIC_WriteByte(Addr_GND,i,PWM_Gamma64[j]);//pwm
    }
    for(i=0x04;i<0x31;i=i+6)
    {
      IS_IIC_WriteByte(Addr_GND,i,PWM_Gamma64[63-j]);//pwm
    }
    for(i=0x06;i<0x31;i=i+6)
    {
      IS_IIC_WriteByte(Addr_GND,i,0);//pwm
    }
  }
  IS_IIC_WriteByte(Addr_GND,0x81,0x00);//pwm update
  delay(60);
}

for(j=0;j<63;j++)
{
  for(k=0x56;k<=0x5C;k=k+2)
  {
    IS_IIC_WriteByte(Addr_GND,0x7E,0xC6);//unlock
    IS_IIC_WriteByte(Addr_GND,0x7A,k);//choose page
    for(i=0x02;i<0x31;i=i+6)
    {
      IS_IIC_WriteByte(Addr_GND,i,PWM_Gamma64[63-j]);//pwm
    }
    for(i=0x04;i<0x31;i=i+6)
    {
      IS_IIC_WriteByte(Addr_GND,i,0);//pwm
    }
    for(i=0x06;i<0x31;i=i+6)
    {
      IS_IIC_WriteByte(Addr_GND,i,PWM_Gamma64[j]);//pwm
    }
  }
  IS_IIC_WriteByte(Addr_GND,0x81,0x00);//pwm update
  delay(60);
}

for(j=0;j<63;j++)
{
  for(k=0x56;k<=0x5C;k=k+2)
  {
    IS_IIC_WriteByte(Addr_GND,0x7E,0xC6);//unlock
    IS_IIC_WriteByte(Addr_GND,0x7A,k);//choose page
    for(i=0x02;i<0x31;i=i+6)
    {
      IS_IIC_WriteByte(Addr_GND,i,0);//pwm
    }
    for(i=0x04;i<0x31;i=i+6)
    {
      IS_IIC_WriteByte(Addr_GND,i,PWM_Gamma64[j]);//pwm
    }
    for(i=0x06;i<0x31;i=i+6)
    {
      IS_IIC_WriteByte(Addr_GND,i,PWM_Gamma64[63-j]);//pwm
    }
  }
  IS_IIC_WriteByte(Addr_GND,0x81,0x00);//pwm update
  delay(60);
}
}

```