

Cable release for reset 0.6 m for 3RU2 Size S00...S3





product brand name	SIRIUS
product category	Reset modules
product designation	Cable release
design of the product	600 mm long
product type designation	3RU29





General technical data	
size of overload relay	S00, S0
Substance Prohibitance (Date)	07/01/2006
Net Weight	0.07 kg

Ambient conditions	
ambient temperature	
<ul style="list-style-type: none"> <li>during operation</li> </ul>	-20 ... +70 °C
<ul style="list-style-type: none"> <li>during storage</li> </ul>	-50 ... +80 °C

Installation/ mounting/ dimensions	
length	600 mm
mounting diameter	6.5 mm

### Approvals Certificates

Environment	General Product Approval	Maritime application
<a href="#">Environmental Conformations</a>	  	 

Maritime application	other
  	 <a href="#">Confirmation</a>

### Further information

Information on the packaging  
<https://support.industry.siemens.com/cs/ww/en/view/109813875>

Information for data generation and storage  
<https://support.industry.siemens.com/cs/ww/en/view/109995012>

Information- and Downloadcenter (Catalogs, Brochures,...)  
<https://www.siemens.com/ic10>

Industry Mall (Online ordering system)  
<https://mall.industry.siemens.com/mall/en/en/Catalog/product?mlfb=3RU2900-1C>

Cax online generator  
<https://support.automation.siemens.com/WW/CAXorder/default.aspx?lang=en&mlfb=3RU2900-1C>

Service&Support (Manuals, Certificates, Characteristics, FAQs,...)  
<https://support.industry.siemens.com/cs/ww/en/ps/3RU2900-1C>

Image database (product images, 2D dimension drawings, 3D models, device circuit diagrams, EPLAN macros, ...)  
[https://www.automation.siemens.com/bilddb/cax\\_de.aspx?mlfb=3RU2900-1C&lang=en](https://www.automation.siemens.com/bilddb/cax_de.aspx?mlfb=3RU2900-1C&lang=en)

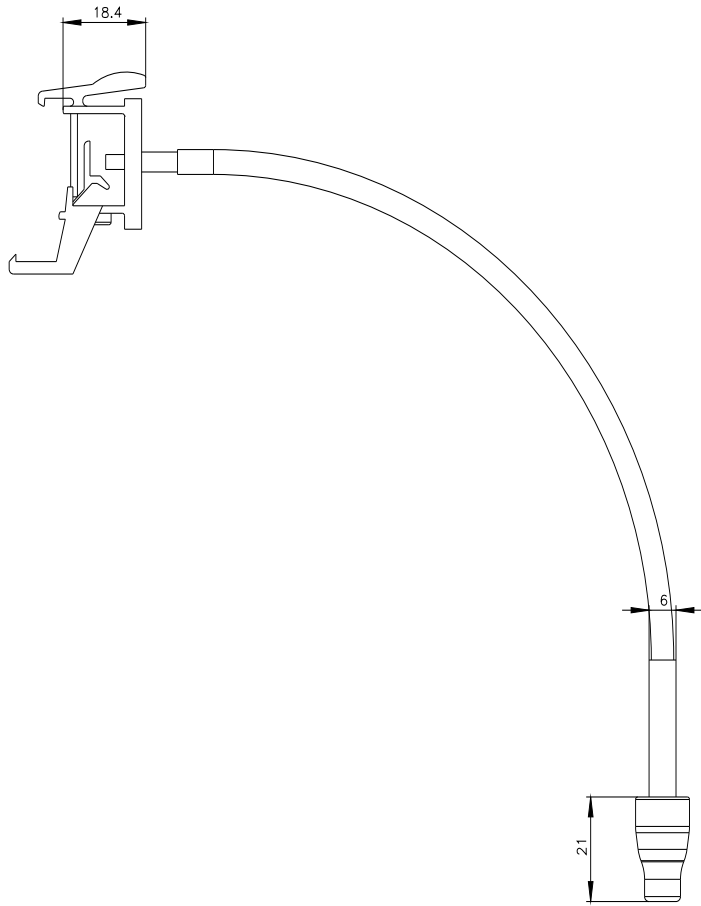
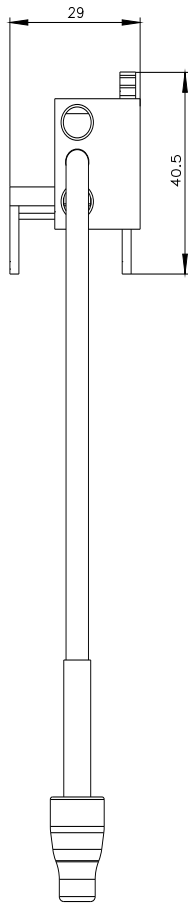

---

last modified:

4/2/2025 