

SF2085A

96.00 MHz
SAW Filter

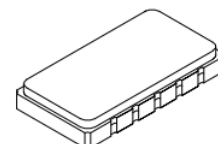

SMP-53-S

- **Low Insertion Loss**
- **13.3 X 6.5 mm Surface-Mount Case**
- **Complies with Directive 2002/95/EC (RoHS)**
- **Moisture Sensitivity Level: 1**

Absolute Maximum Ratings

Rating	Value	Units
Maximum Incident Power in Passband	+13	dBm
Max. DC voltage between any 2 terminals	30	VDC
Storage Temperature Range	-40 to +85	°C
Suitable for lead-free soldering - Max Soldering Temperature	260°C for 30 s	

Electrical Characteristics

Characteristic	Sym	Notes	Min	Typ	Max	Units
Nominal Center Frequency	f_c			96.000		MHz
Insertion Loss				17	19	dB
Passband Ripple		CF \pm 15 MHz			2	dB p-p
Passband		1dB	35			MHz
Passband		3dB		36		MHz
Group Delay	$F_c \pm 15$ MHz	within adjacent 5 MHz windows			50	nsec
Amplitude Ripple	$F_c \pm 15$ MHz	within adjacent 5 MHz windows			1.5	dB
VSWR at F_c					1.8	
Group Delay		Absolute Group Delay Variation; CF \pm 15 MHz		180		nsec
Rejection		40 dB			50	MHz
Temperature		Operating	-40		85	°C
		Storage	-40		85	
Matching to 50 Ω Balanced or Single Ended Impedance			External L-C			
Case Style			SMP-53-S 13.3 x 6.5 mm Nominal Footprint			
Lid Symbolization (YY=year, WW=week, S=shift, ## = Sequence Code)			RFM, SF2085A, YYWWS##			

 **CAUTION: Electrostatic Sensitive Device. Observe precautions for handling.**

NOTES:

1. The design, manufacturing process, and specifications of this device are subject to change.
2. US or International patents may apply.
3. RoHS compliant from the first date of manufacture.

9 Aug 2005 13:06:30

CH1 DEL 100 ns/ REF 800 ns
S21 3: -20 .075 ns -5 .000 000 MHz

CH3 LOG 1 dB/ REF -17.8 dB
S21 3: -.34120 dB -5 .000 000 MHz

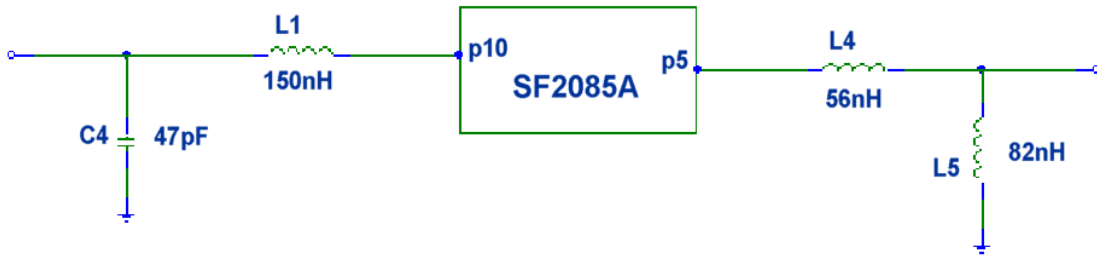
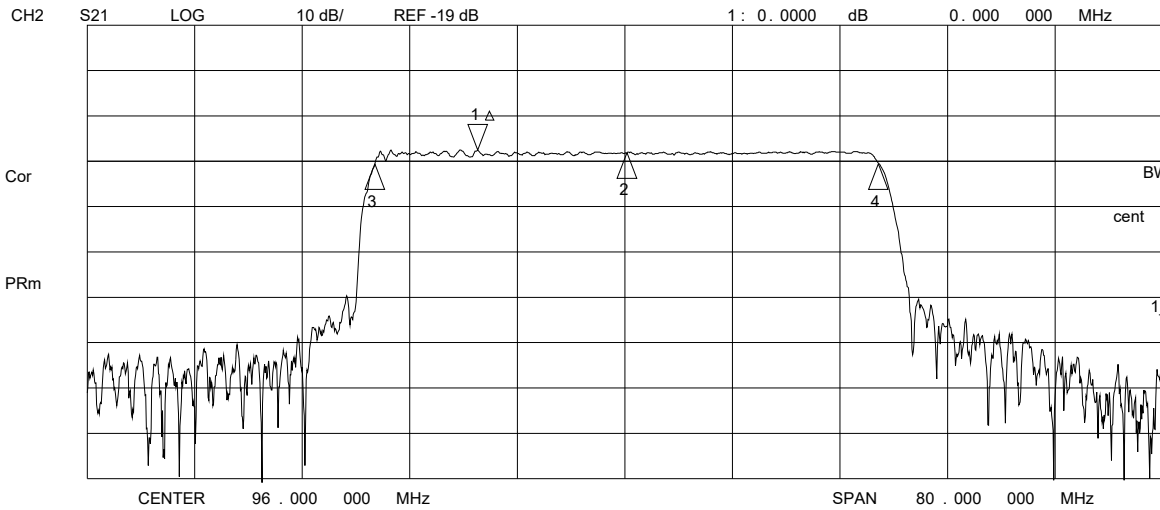
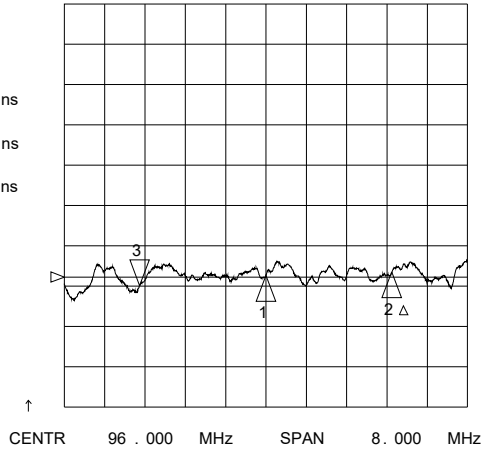
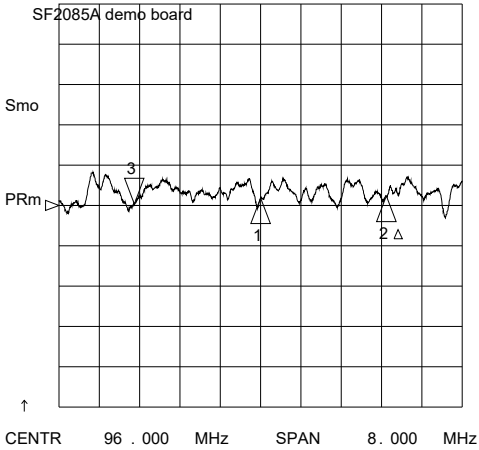

SMP-53-S Case

10-Terminal Ceramic Surface-Mount Case

13.3 x 6.5 mm Nominal Footprint

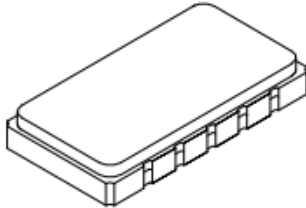

Case Dimensions

Dimension	mm			Inches		
	Min	Nom	Max	Min	Nom	Max
A		13.3			.524	
B		6.5			.256	
C			2.00			.078
D		2.3			.091	
E		1.91			.075	
F		1.02			.040	
G		1.0			0.039	

Electrical Connections

Connection	Terminals
Input	10
Input Return	1
Output	5
Output Return	6
Ground	All others

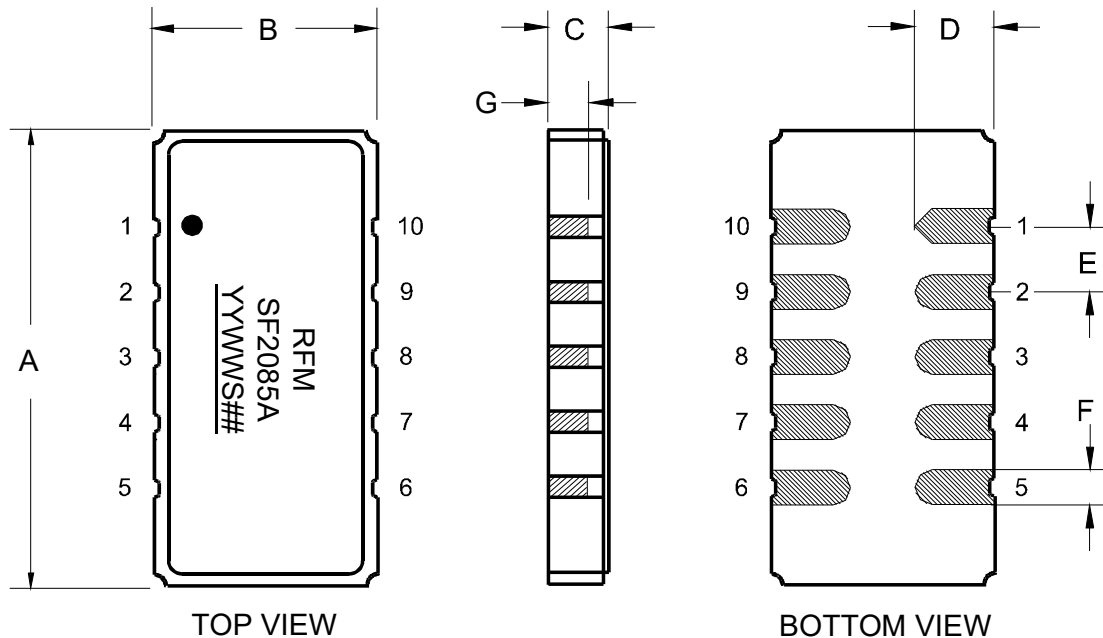

Tape and Reel Specifications

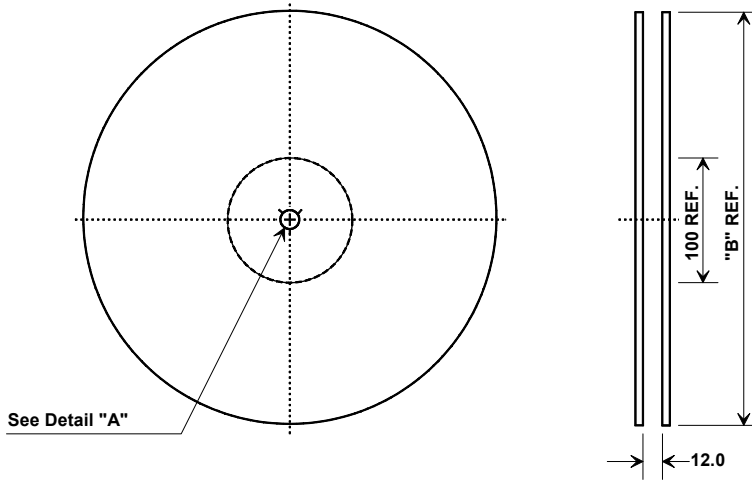

Tape and Reel Standard per ANSI/EIA-481

"B"		Quantity Per Reel
Nominal Size		
Inches	millimeters	
7	178	500
13	330	1000

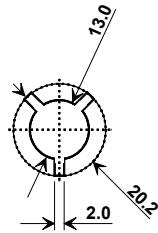

COMPONENT ORIENTATION and DIMENSIONS

Carrier Tape Dimensions	
Cover Tape	21.3 mm
Ao	.274 ± .004 (7.0)
Bo	.542 ± .004 (13.76)
Ko	.088 ± .004 (2.2)
Pitch	12 mm
W	24 mm
Tape Length	86 M
Pockets/M	83/M

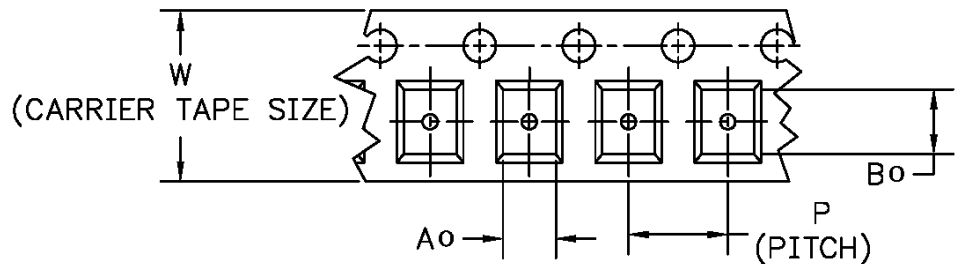
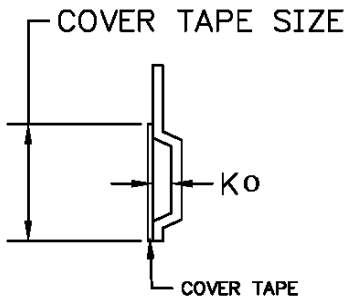

Recommended Reflow Profile

1. Preheating shall be fixed at 150~180°C for 60~90 seconds.
2. Ascending time to preheating temperature 150°C shall be 30 seconds min.
3. Heating shall be fixed at 220°C for 50~80 seconds and at 260°C +0/-5°C peak (10 seconds).
4. Time: 5 times maximum.

