

# 100 Watt EBM Series Encased DC/DC Converter



Typical Unit

Output Voltage (V)	Output Current (A)	Input Voltage Range (V)
5	20	57.6-160
12	8.3	57.6-160
24	4.2	57.6-160

Optimized for harsh environments in industrial/railway applications, the EBM DC-DC converter series offer regulated outputs in an industry-standard eighth brick fully encased package.

## FEATURES

- DC input range: 57.6-160V  
(Covers both 96V and 110V input range)
- Encapsulated circuitry for optimal thermal/vibration performance
- Regulation:  $\pm 0.3\%$  from no load to full load
- High Efficiency
- Maximum baseplate operating temperature: 100°C, full load
- Over-current & Over-temperature protection
- Diode rectifier topology
- Stable no-load operation
- Support Pre-Bias startup

## SAFETY FEATURES

- Reinforced insulation
- 3000Vrms input to output isolation
- EN 50155
- UL 60950-1
- CAN/CSA-C22.2 No. 60950-1
- EN 60950-1
- RoHS compliant

## PRODUCT OVERVIEW

The EBM series regulated converter module deliver a 5V, 12V or 24V output @  $V_{in} = 57.6 - 160$  Vdc in an industry standard eighth brick fully encased package at astonishing efficiency. The fully isolated (3000Vrms) EBM series accept a 57.6 to 160 Volt DC input voltage range with a reinforced insulation system. Typical applications include industrial, railway and transportation applications.

The EBM's diode-rectifier topology and fixed frequency operations means excellent efficiencies. A wealth of electronic protection features include input under voltage lockout, output over voltage lockout protection, output current limit, current sharing, short circuit hiccup,  $V_{out}$  overshoot, and over temperature shutdown.

Available options include various pin lengths and flanged baseplate. The EBM series is designed to meet all UL and IEC emissions, safety, and flammability certifications.

Slotted - Flanged Baseplate  
DOSA Pinout  
Pin Dia : 0.040 / 0.060

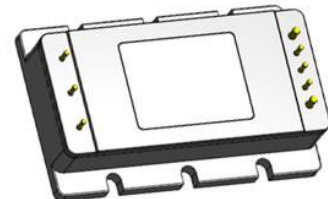

Baseplate Without Flange  
DOSA Pinout  
Pin Dia : 0.040 / 0.060

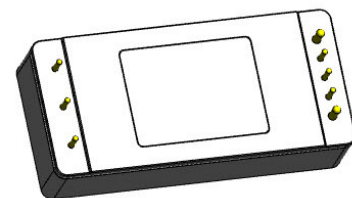

# 100 Watt EBM Series Encased DC/DC Converter



## PERFORMANCE SPECIFICATIONS SUMMARY AND ORDERING GUIDE ① ②

Root Model ①	Output						Input				Efficiency		
	V <sub>OUT</sub> (V)	I <sub>OUT</sub> (A, max)	Total Power (W)	Ripple & Noise (mVp-p)		Regulation (max.)		V <sub>IN</sub> Nom. (V)	Range (V)	I <sub>IN</sub> , no load (mA)			I <sub>IN</sub> , full load (A)
				Typ.	Max.	Line	Load						
110TS5.100EBM	5	20	100	80	150	±0.2%	±0.3%	110	57.6-160	150	2.06	83.0%	85.5%
110TS12.100EBM	12	8.3	100	50	120	±0.6%	±0.5%	110	57.6-160	50	2.50	87.0%	87.4%
110TS24.100EBM	24	4.2	100	100	240	±0.3%	±0.3%	110	57.6-160	20	2.50	86.5%	88.2%

① Please refer to the part number structure for additional options and complete ordering part numbers.

② All specifications are at nominal line voltage and full load, +25 °C. Unless otherwise noted. See detailed specifications. Output capacitors are 1 µF ceramic in parallel with 10 µF electrolytic. I/O caps are necessary for our test equipment and may not be needed for your application.

## PART NUMBER STRUCTURE

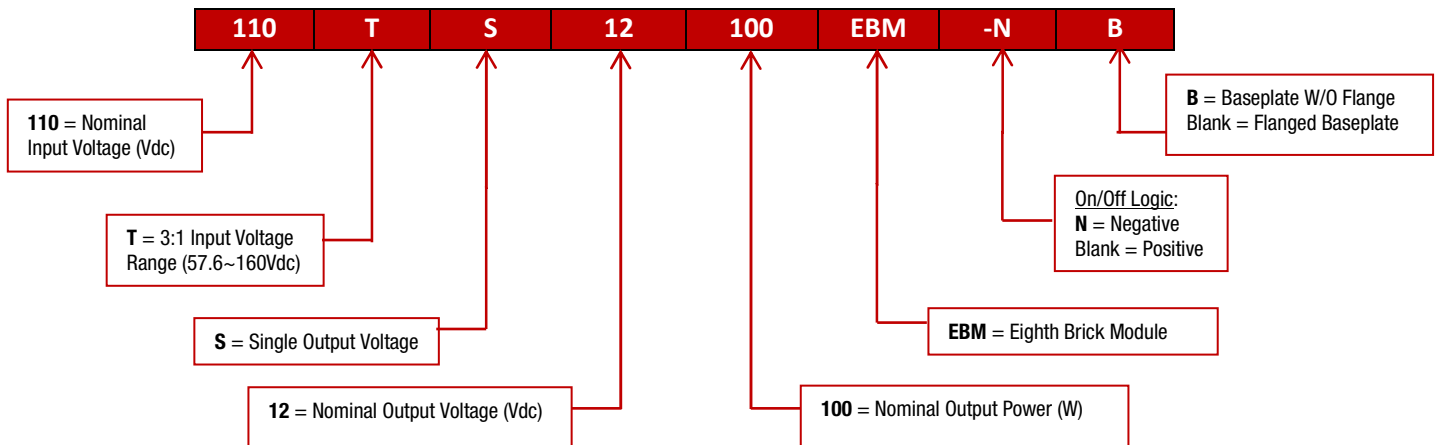

# 100 Watt EBM Series Encased DC/DC Converter



## FUNCTIONAL SPECIFICATIONS

ABSOLUTE MAXIMUM RATINGS	Conditions	Minimum	Typical/Nominal	Maximum	Units
Input Voltage, Continuous		0		160	Vdc
Input Voltage, Transient	100 mS max. duration			170	Vdc
Isolation Voltage	Input to output			3000	Vrms
	Input to Baseplate			1500	Vrms
	Output to Baseplate			1500	Vrms
On/Off Remote Control	Referred to -Vin	0		15	Vdc
Operating Temperature Range	Ambient Temperature	-40		85	°C
Storage Temperature Range	Baseplate Temperature	-55		125	°C
Absolute Baseplate Temperature				100	°C

Absolute maximums are stress ratings. Exposure of devices to greater than any of these conditions may adversely affect long-term reliability. Proper operation under conditions other than those listed in the Performance/Functional Specifications Table is not implied nor recommended.

## INPUT

Operating Input Voltage Range		57.6		160	Vdc
Turn-on Voltage Threshold		52	54.5	57	Vdc
Turn-off Voltage Threshold		50	52	56	Vdc

## FEATURES and OPTIONS

Conditions ①	Minimum	Typical/Nominal	Maximum	Units	
<b>Primary On/Off control (designed to be driving with an open collector logic, Voltages referenced to -Vin)</b>					
<b>“Blank” suffix:</b>					
Positive Logic, ON state	ON = pin open or external voltage	3.5		15	V
Positive Logic, OFF state	OFF = ground pin or external voltage	0		1	V
Control Current	open collector/drain		1	2	mA
<b>“N” suffix:</b>					
Negative Logic, ON state	ON = ground pin or external voltage	-0.1		0.8	V
Negative Logic, OFF state	OFF = pin open or external voltage	2.5		15	V
Control Current	open collector/drain		1	2	mA
Remote Sense Compliance	Sense pins connected externally to respective Vout pins		5		%

## ENVIRONMENTAL

Operating Ambient Temperature	Ambient Temperature	-40		85	°C
	Baseplate Temperature	-40		110	°C
Storage Temperature		-55		125	°C
Semiconductor Junction Temperature				125	°C
Thermal Protection	Average PCB Temperature		125		°C
Thermal Protection Restart Hysteresis					°C
Electromagnetic Interference	External filter required		B		Class
Conducted, EN55022/CISPR22					

# 100 Watt EBM Series Encased DC/DC Converter



## FUNCTIONAL SPECIFICATIONS

GENERAL and SAFETY					
Insulation Safety Rating			Reinforced		
Isolation Resistance		10			MΩ
Isolation Capacitance				500	pF
Safety	Certified to UL-60950-1, CSA-C22.2 No.60950-1, IEC/EN60950-1, 2nd edition		Yes		
MECHANICAL	Conditions	Minimum	Typical/Nominal	Maximum	Units
Through Hole Pin Diameter			0.06 & 0.04		Inches
			1.524 & 1.016		mm
Through Hole Pin Material			Copper alloy		
TH Pin Plating Metal and Thickness	Nickel subplate		98.4-299		μ-inches
	Gold overplate		4.7-19.6		μ-inches

# 100 Watt EBM Series Encased DC/DC Converter



## FUNCTIONAL SPECIFICATIONS (110TS5.100EBM)

INPUT	Conditions	Minimum	Typical/Nominal	Maximum	Units
<b>Input current</b>					
Full Load Conditions	Vin = nominal		1.06	1.11	A
Low Line input current	Vin = minimum		2.01	2.06	A
Inrush Transient	Vin = 110v		0.1	0.2	A <sup>2</sup> -Sec.
Short Circuit input current			0.1	0.2	A
No Load input current	Iout = minimum, unit=ON		50	150	mA
Shut-Down input current (Off, UV, OT)			15	30	mA
Back Ripple Current	Measured at the input of module with a simulated source impedance of 12 $\mu$ H, 220 $\mu$ F, 450V, across source, 33 $\mu$ F, 250V external capacitors across input pins.			2000	mAp-p
Internal Filter Type/Value			Pi		
Recommended Input fuse				5	A
<b>OUTPUT</b>					
Total Output Power		0	100	101	W
<b>Voltage</b>					
Setting Accuracy	At 100% load, no trim, all conditions	4.95	5	5.05	Vdc
Output Adjust Range		4.950		5.050	Vdc
Overvoltage Protection		6	6.3	6.5	Vdc
<b>Current</b>					
Output Current Range		0	20	20	A
Minimum Load			0		
Current Limit Inception	cold condition	22	25	30	A
<b>Short Circuit</b>					
Short Circuit Current	Hiccup technique - Auto recovery within 1.25% of Vout		2.0	4.0	A
Short Circuit Duration (remove short for recovery)	Output shorted to ground, no damage		Continuous		
Short circuit protection method	Hiccup current limiting		Non-latching		
<b>Regulation</b>					
Line Regulation	Vin = 57.6-160, Vout = nom., full load			$\pm 0.2$	%
Load Regulation	Iout = min. to max., Vin = nom.			$\pm 0.3$	%
Ripple and Noise	20 MHz BW, Cout = 1 $\mu$ F		80	150	mV pk-pk
	paralleled with 10 $\mu$ F				
Temperature Coefficient	At all outputs		0.02		% of Vnom./ $^{\circ}$ C
Maximum Output Capacitance	(Loads : CR mode)			3300	$\mu$ F
	(Loads : CC mode)			3300	$\mu$ F
<b>GENERAL and SAFETY</b>					
Efficiency	Vin=110V, full load	83	85.5		%

# 100 Watt EBM Series Encased DC/DC Converter



## FUNCTIONAL SPECIFICATIONS (110TS5.100EBM)

Isolation Resistance		10			MΩ
Isolation Capacitance				500	μF
Calculated MTBF	Per Telcordia SR-332, Issue 2, Method 1, Class 1, Ground Fixed, Tcase=+25°C		1800		Hours x 10 <sup>3</sup>
<b>DYNAMIC CHARACTERISTICS</b>					
Switching Frequency			200		kHz
<b>Turn On Time</b>					
Rise Time	10% Vout to 90% Vout		15	30	mS
Delay Time	Vin on to 10% Vout		20	30	mS
Dynamic Load Response	50-75-50%, 1A/us, within 1% of Vout			50	μSec
Dynamic Load Peak Deviation	same as above		±100	±300	mV
<b>MECHANICAL</b>	<b>Conditions</b>	<b>Minimum</b>	<b>Typical/Nominal</b>	<b>Maximum</b>	<b>Units</b>
Outline Dimensions (with flange)			2.28 x 1.45 x 0.5		Inches
			57.91 x 36.83 x 12.7		mm
Outline Dimensions (without flange)			2.29 x 1.06 x 0.5		Inches
			58.16 x 26.92 x 12.7		mm
Weight (with flange)			2.23		Ounces
			63.6		Grams

# 100 Watt EBM Series Encased DC/DC Converter



## PERFORMANCE DATA (110TS5.100EBM)

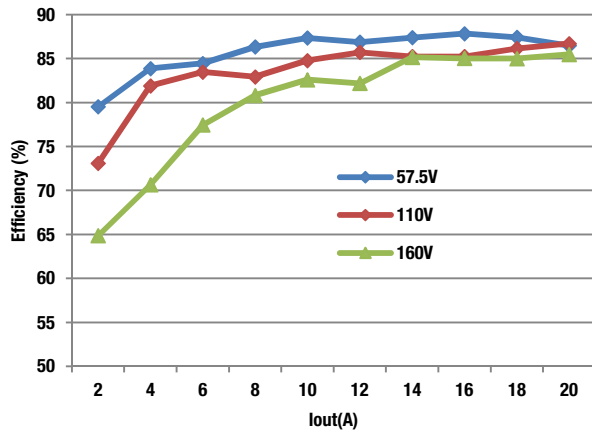

Figure 1 Efficiency vs. Load Current

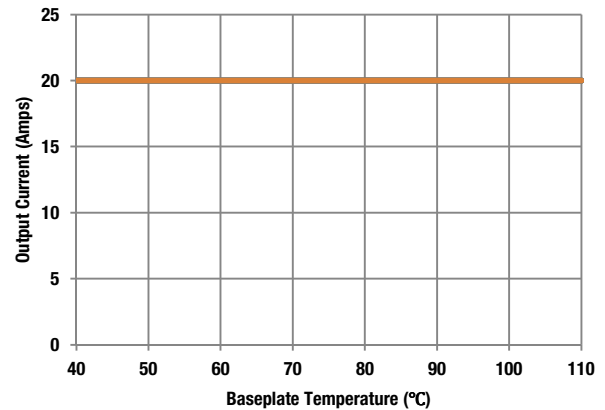

Figure 2 Thermal Derating vs. Baseplate temperature

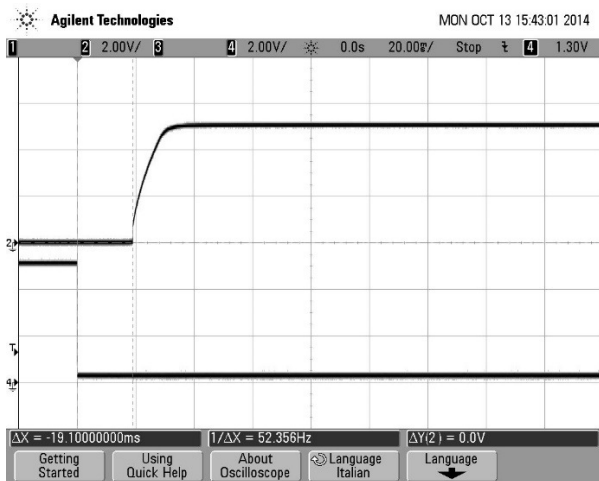

Figure 3: Turn-on transient at zero load current  
(20 mS/div, Top Trace: Vout, 2V/div; Bottom Trace: ON/OFF, 2V/div)

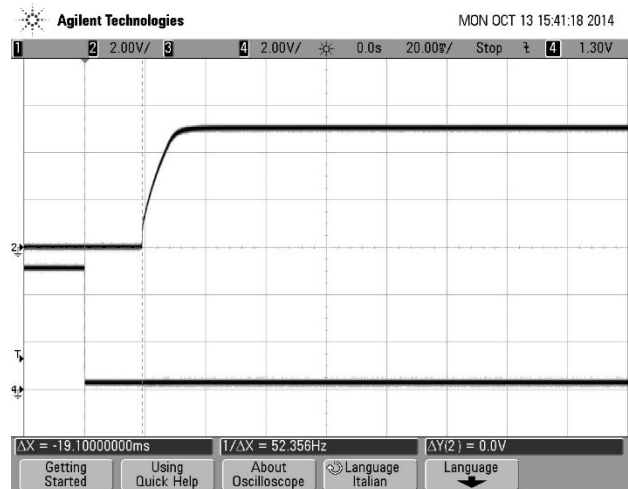

Figure 4: Turn-on transient at full load current  
(20 mS/div, Top Trace: Vout, 2V/div; Bottom Trace: ON/OFF, 2V/div)

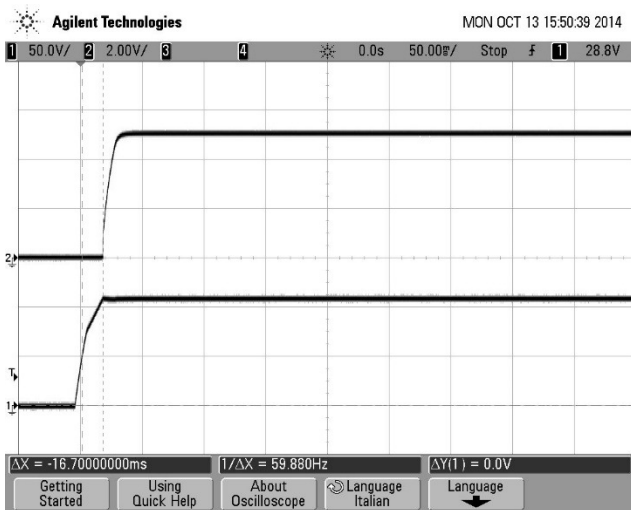

Figure 5: Turn-on transient at zero load current  
(50 mS/div, Top Trace: Vout, 2V/div; Bottom Trace: Vin, 50V/div)

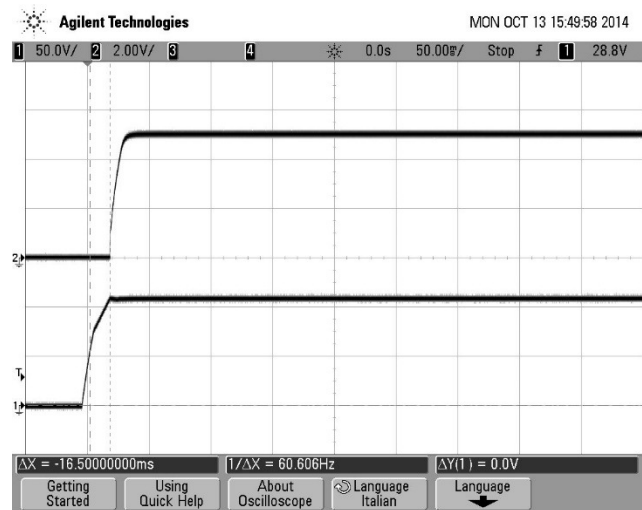

Figure 6: Turn-on transient at full load current  
(50 mS/div, Top Trace: Vout, 2V/div; Bottom Trace: Vin, 50V/div)

# 100 Watt EBM Series Encased DC/DC Converter



## Thermal Derating (110TS5.100EBM, Unit mounted on a 10 X 10 inch PCB)

**TRANSVERSE (Airflow from Vin- to Vin+)**

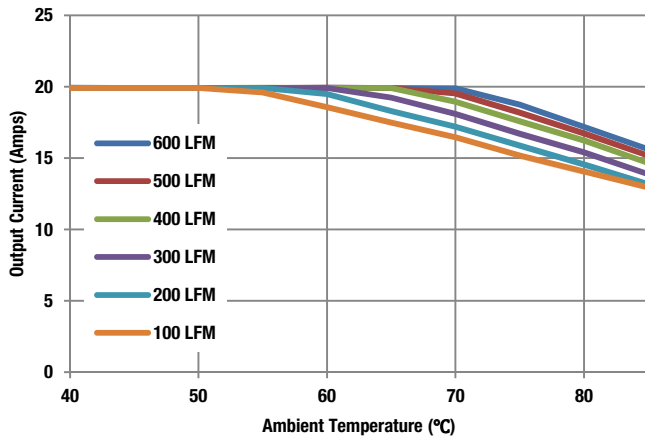

Figure 7 Maximum Current Temperature Derating (Vin = 57.6V)

**LONGITUDINAL (Airflow from Vin to Vout)**

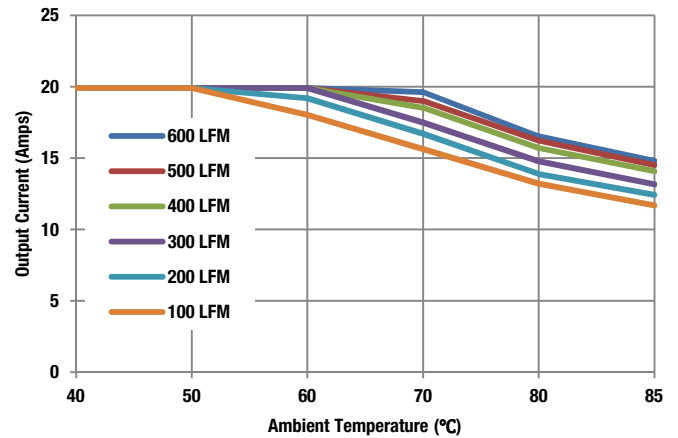

Figure 8 Maximum Current Temperature Derating (Vin = 57.6V)

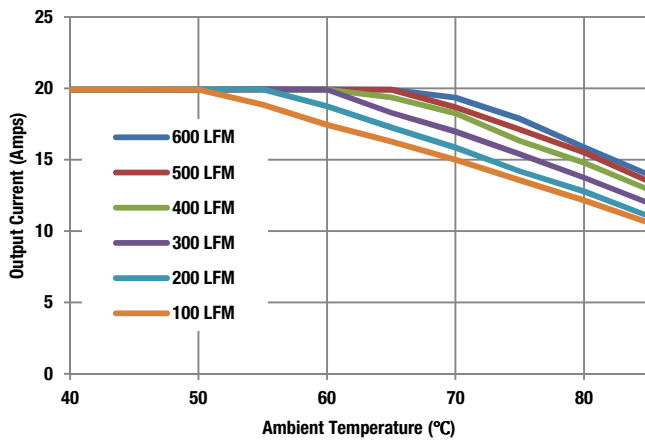

Figure 9 Maximum Current Temperature Derating (Vin = 110V)

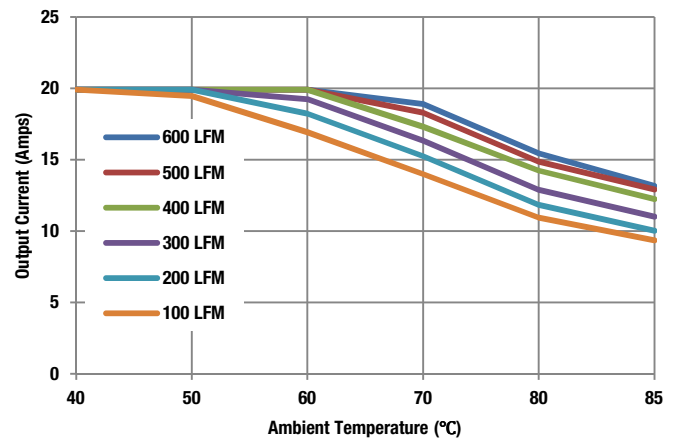

Figure 10 Maximum Current Temperature Derating (Vin = 110V)

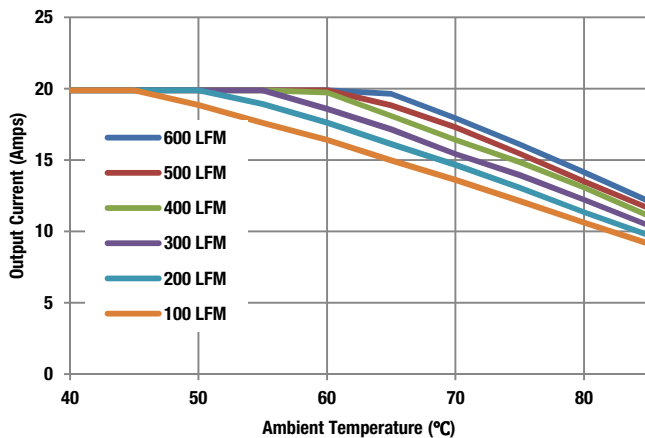

Figure 11 Maximum Current Derating (Vin = 160V)

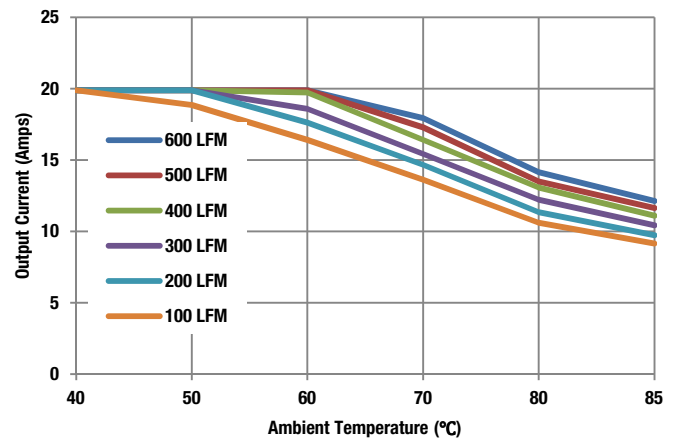

Figure 12 Maximum Current Derating (Vin = 160V)



# 100 Watt EBM Series Encased DC/DC Converter



## FUNCTIONAL SPECIFICATIONS (110TS12.100EBM)

INPUT	Conditions	Minimum	Typical/Nominal	Maximum	Units
<b>Input current</b>					
Full Load Conditions	Vin = nominal		1.00	1.50	A
Low Line input current	Vin = minimum		1.98	2.50	A
Inrush Transient	Vin = 110V		0.1	0.2	A <sup>2</sup> -Sec.
Short Circuit input current			0.02	0.05	A
No Load input current	Iout = minimum, unit=ON		7	50	mA
Shut-Down input current (Off, UV, OT)			5	50	mA
Back Ripple Current	Measured at the input of module with a simulated source impedance of 12 $\mu$ H, 220 $\mu$ F, 450V, across source, 33 $\mu$ F, 250V external capacitors across input pins.			600	mAp-p
Internal Filter Type/Value			Pi		
Recommended Input fuse				5	A
<b>OUTPUT</b>					
Total Output Power		0	99.60	100.60	W
<b>Voltage</b>					
Setting Accuracy	At 100% load, no trim, all conditions	11.88	12	12.12	Vdc
Output Adjust Range		10.8		13.2	Vdc
Overvoltage Protection		14	16	18	Vdc
<b>Current</b>					
Output Current Range		0	8.30	8.30	A
Minimum Load			0		
Current Limit Inception	cold condition	9.13	10.50	12.45	A
<b>Short Circuit</b>					
Short Circuit Current	Hiccup technique - Auto recovery within 1.25% of Vout		1.4	3	A
Short Circuit Duration (remove short for recovery)	Output shorted to ground, no damage		Continuous		
Short circuit protection method	Hiccup current limiting		Non-latching		
<b>Regulation</b>					
Line Regulation	Vin = 57.6-160, Vout = nom., full load			$\pm 0.6$	%
Load Regulation	Iout = min. to max., Vin = nom.			$\pm 0.5$	%
Ripple and Noise	20 MHz BW, Cout = 1 $\mu$ F		50	120	mV pk-pk
	paralleled with 10 $\mu$ F				
Temperature Coefficient	At all outputs			0.02	% of Vnom./ $^{\circ}$ C
Maximum Output Capacitance	(Loads : CR mode)			1000	$\mu$ F
	(Loads : CC mode)			1000	$\mu$ F
<b>GENERAL and SAFETY</b>					
Efficiency	Vin=110V, full load	87	87.4		%

# 100 Watt EBM Series Encased DC/DC Converter



## FUNCTIONAL SPECIFICATIONS (110TS12.100EBM)

Isolation Resistance			10		MΩ
Isolation Capacitance			500		pF
Calculated MTBF	Per Telcordia SR-332, Issue 2, Method 1, Class 1, Ground Fixed, Tcase=+25°C		1800		Hours x 10 <sup>3</sup>
<b>DYNAMIC CHARACTERISTICS</b>					
Switching Frequency			200		kHz
<b>Turn On Time</b>					
Rise Time	10% Vout to 90% Vout		10	25	mS
Delay Time	Vin on to 10% Vout		18	30	mS
Dynamic Load Response	50-75-50%, 1A/us, within 1% of Vout		400	600	μSec
Dynamic Load Peak Deviation	same as above		±200	±300	mV
<b>MECHANICAL</b>	<b>Conditions</b>	<b>Minimum</b>	<b>Typical/Nominal</b>	<b>Maximum</b>	<b>Units</b>
Outline Dimensions (with flange)			2.28 x 1.45 x 0.50		Inches
			57.91 x 36.83 x 12.7		mm
Outline Dimensions (without flange)			2.29 x 1.06 x 0.5		Inches
			58.16 x 26.92 x 12.7		mm
Weight (with flange)			2.23		Ounces
			63.6		Grams

# 100 Watt EBM Series Encased DC/DC Converter



## PERFORMANCE DATA (110TS12.100EBM)

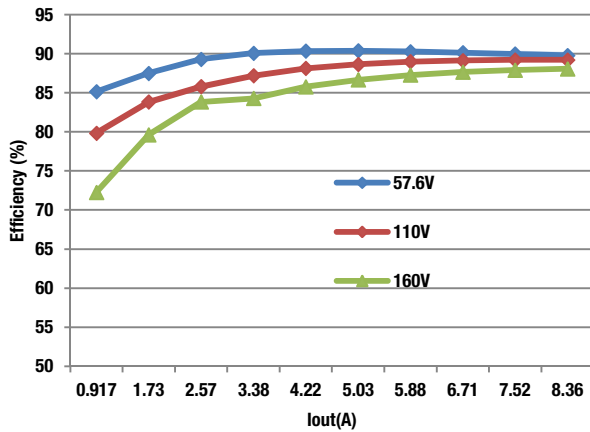

Figure 13 Efficiency vs. Load Current

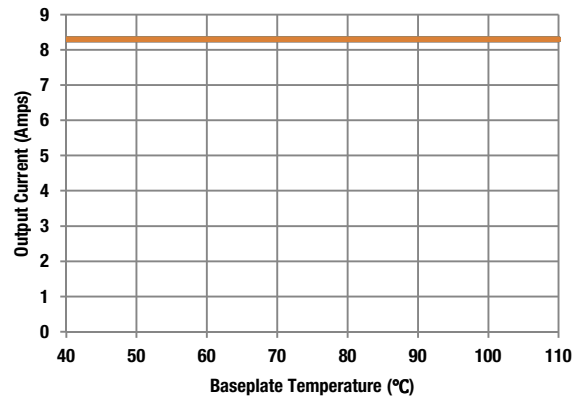

Figure 14 Thermal Derating vs. Baseplate temperature



Figure 15: Turn-on transient at zero load current  
(10 mS/div, Top Trace: Vout, 5V/div; Bottom Trace: ON/OFF, 2V/div)



Figure 16: Turn-on transient at full load current  
(10 mS/div, Top Trace: Vout, 5V/div; Bottom Trace: ON/OFF, 2V/div)



Figure 17: Turn-on transient at zero load current  
(10 mS/div, Top Trace: Vout, 5V/div; Bottom Trace: Vin, 50V/div)

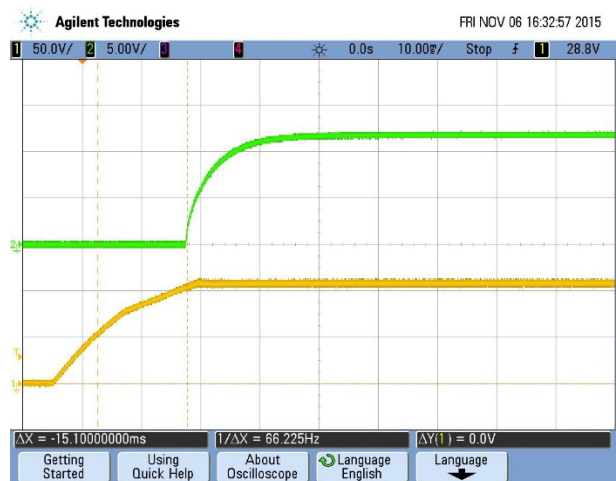

Figure 18: Turn-on transient at full load current  
(10 mS/div, Top Trace: Vout, 5V/div; Bottom Trace: Vin, 50V/div)

# 100 Watt EBM Series Encased DC/DC Converter



## Thermal Derating (110TS12.100EBM, Unit mounted on a 10 X 10 inch PCB)

TRANSVERSE (Airflow from Vin- to Vin+)

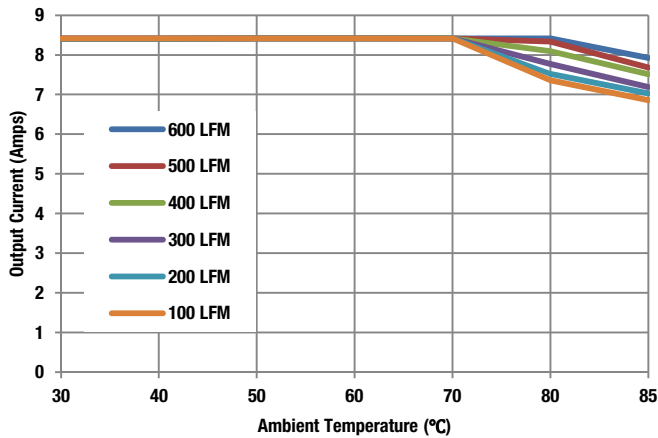

Figure 19 Maximum Current Temperature Derating (Vin = 57.6V)

LONGITUDINAL (Airflow from Vin to Vout)

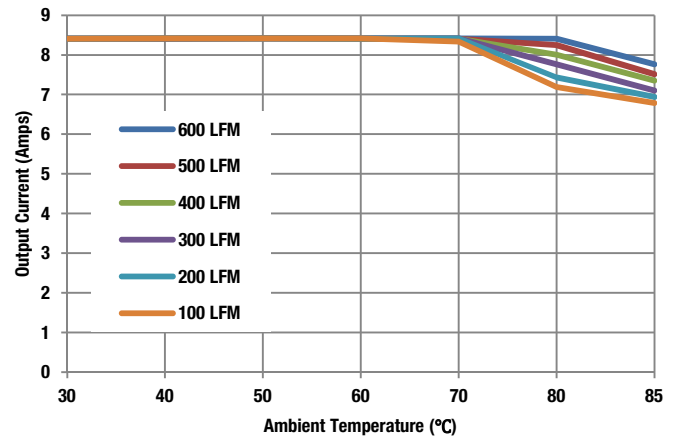

Figure 20 Maximum Current Temperature Derating (Vin = 57.6V)

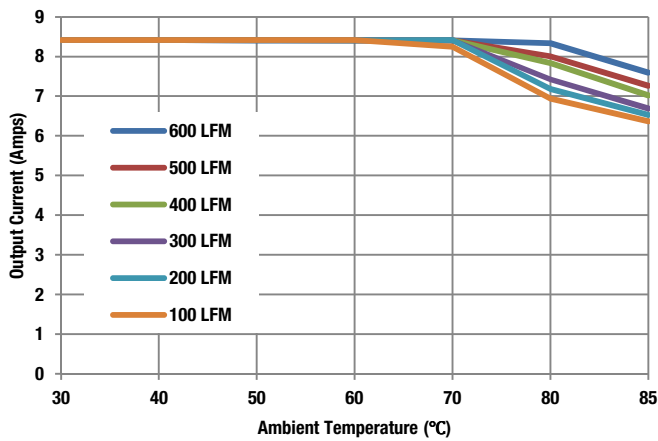

Figure 21 Maximum Current Temperature Derating (Vin = 110V)

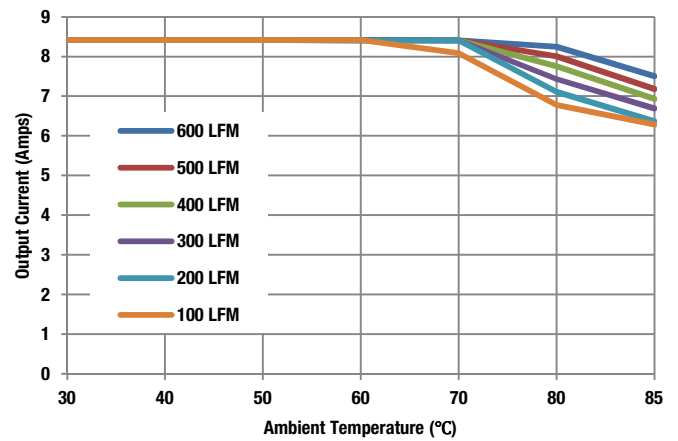

Figure 22 Maximum Current Temperature Derating (Vin = 110V)

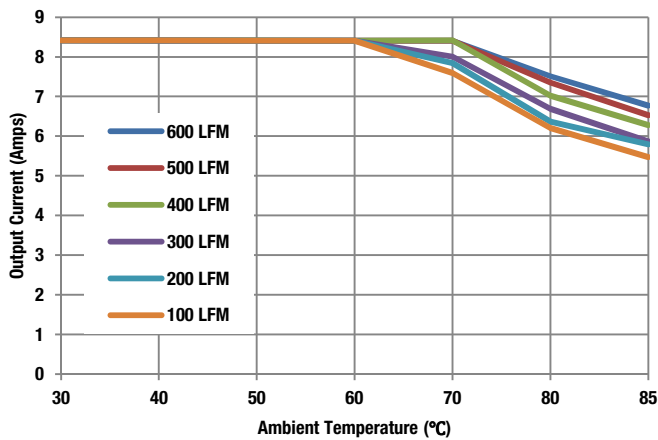

Figure 23 Maximum Current Derating (Vin = 160V)

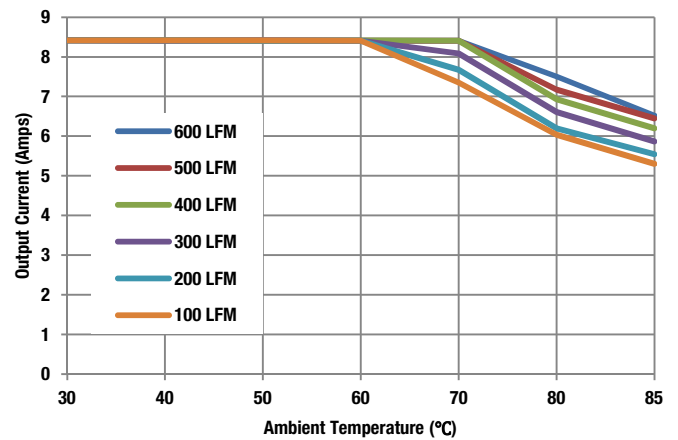

Figure 24 Maximum Current Derating (Vin = 160V)

# 100 Watt EBM Series Encased DC/DC Converter



## FUNCTIONAL SPECIFICATIONS (110TS24.100EBM)

INPUT	Conditions	Minimum	Typical/Nominal	Maximum	Units
<b>Input Current</b>					
<b>Full Load Conditions</b>	Vin = nominal		1.00	1.50	A
<b>Low Line input current</b>	Vin = minimum		2.02	2.50	A
<b>Inrush Transient</b>	Vin = 110v		0.1	0.2	A <sup>2</sup> -Sec.
<b>Short Circuit input current</b>			0.03	0.05	A
<b>No Load input current</b>	Iout = minimum, unit=ON		7	20	mA
<b>Shut-Down input current (Off, UV, OT)</b>			5	20	mA
<b>Back Ripple Current</b>	Measured at the input of module with a simulated source impedance of 12μH, 220μF, 450V, across source, 33μF, 250V external capacitors across input pins.			500	mAp-p
<b>Internal Filter Type/Value</b>			Pi		
<b>Recommended Input fuse</b>				5	A
<b>OUTPUT</b>					
<b>Total Output Power</b>		0	100.80	101.81	W
<b>Voltage</b>					
<b>Setting Accuracy</b>	At 100% load, no trim, all conditions	23.76	24	24.24	Vdc
<b>Output Adjust Range</b>		21.6		26.4	Vdc
<b>Oversoltage Protection</b>		28.8	32	36	Vdc
<b>Current</b>					
<b>Output Current Range</b>		0	4.20	4.20	A
<b>Minimum Load</b>			0		
<b>Current Limit Inception</b>	cold condition	4.62	5.67	6.30	A
<b>Short Circuit</b>					
<b>Short Circuit Current</b>	Hiccup technique - Auto recovery within 1.25% of Vout		1.4	3	A
<b>Short Circuit Duration</b>	Output shorted to ground, no damage		Continuous		
<b>(remove short for recovery)</b>					
<b>Short circuit protection method</b>	Hiccup current limiting		Non-latching		
<b>Regulation</b>					
<b>Line Regulation</b>	Vin = 57.6-160, Vout = nom., full load			±0.2	%
<b>Load Regulation</b>	Iout = min. to max., Vin = nom.			±0.3	%
<b>Ripple and Noise</b>	20 MHz BW, Cout = 1μF		100	240	mV pk-pk
	paralleled with 10μF				
<b>Temperature Coefficient</b>	At all outputs			0.02	% of Vnom./°C
<b>Maximum Output Capacitance</b>	(Loads : CR mode)			560	μF
	(Loads : CC mode)			560	μF
<b>GENERAL and SAFETY</b>					
<b>Efficiency</b>	Vin=110V, full load	86.5	88.2		%

# 100 Watt EBM Series Encased DC/DC Converter



## FUNCTIONAL SPECIFICATIONS (110TS24.100EBM)

Isolation Resistance			10		MΩ
Isolation Capacitance			500		pF
Calculated MTBF	Per Telcordia SR-332, Issue 2, Method 1, Class 1, Ground Fixed, Tcase=+25°C		1800		Hours x 10 <sup>3</sup>
<b>DYNAMIC CHARACTERISTICS</b>					
Switching Frequency			200		KHz
<b>Turn On Time</b>					
Rise Time	10% Vout to 90% Vout		10	25	mS
Delay Time	Vin on to 10% Vout		18	30	mS
Dynamic Load Response	50-75-50%, 1A/us, within 1% of Vout		300	500	μSec
Dynamic Load Peak Deviation	same as above		±400	±600	mV
<b>MECHANICAL</b>	<b>Conditions</b>	<b>Minimum</b>	<b>Typical/Nominal</b>	<b>Maximum</b>	<b>Units</b>
Outline Dimensions (with flange)			2.28 x 1.45 x 0.5		Inches
			57.91 x 36.83 x 12.7		mm
Outline Dimensions (without flange)			2.29 x 1.06 x 0.5		Inches
			58.16 x 26.92 x 12.7		mm
Weight (with flange)			2.23		Ounces
			63.6		Grams

# 100 Watt EBM Series Encased DC/DC Converter



## PERFORMANCE DATA (110TS24.100EBM)

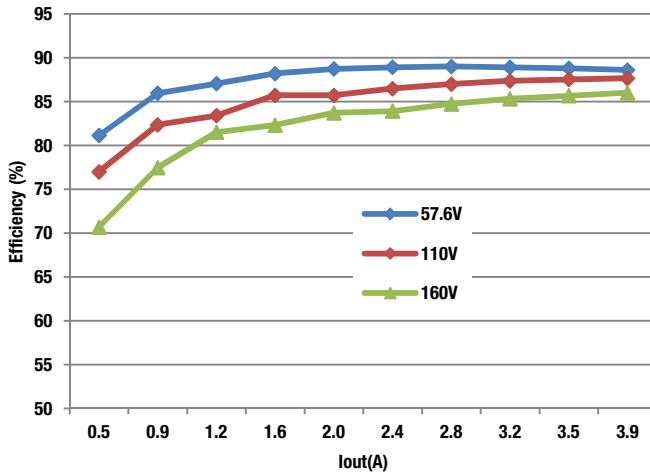

Figure 25 Efficiency vs. Load Current

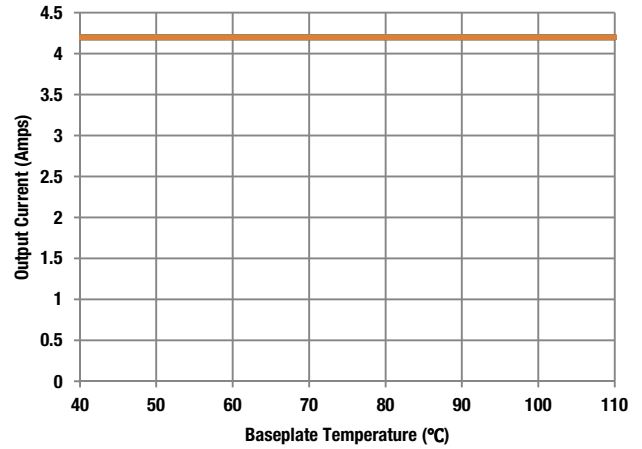

Figure 26 Thermal Derating vs. Baseplate temperature



Figure 27: Turn-on transient at zero load current  
(10 mS/div, Top Trace: Vout, 10V/div; Bottom Trace: ON/OFF, 2V/div)



Figure 28: Turn-on transient at full load current  
(10 mS/div, Top Trace: Vout, 10V/div; Bottom Trace: ON/OFF, 2V/div)

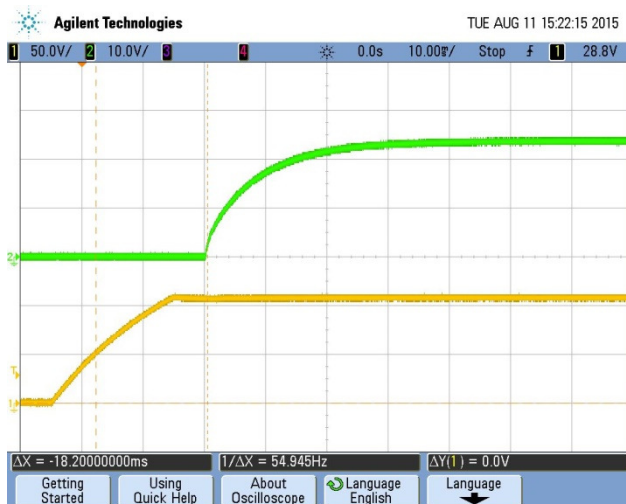

Figure 29: Turn-on transient at zero load current  
(10 mS/div, Top Trace: Vout, 10V/div; Bottom Trace: Vin, 50V/div)



Figure 30: Turn-on transient at full load current  
(10 mS/div, Top Trace: Vout, 10V/div; Bottom Trace: Vin, 50V/div)

# 100 Watt EBM Series Encased DC/DC Converter



## Thermal Derating (110TS24.100EBM, Unit mounted on a 10 X 10 inch PCB)

**TRANSVERSE (Airflow from Vin- to Vin+)**

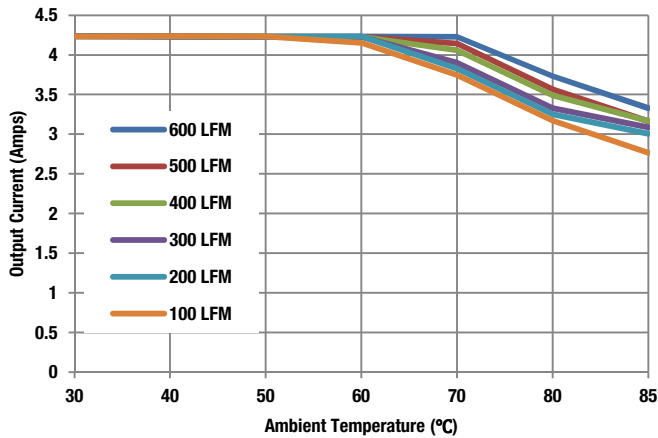

Figure 31 Maximum Current Temperature Derating (Vin = 57.6V)

**LONGITUDINAL (Airflow from Vin to Vout)**

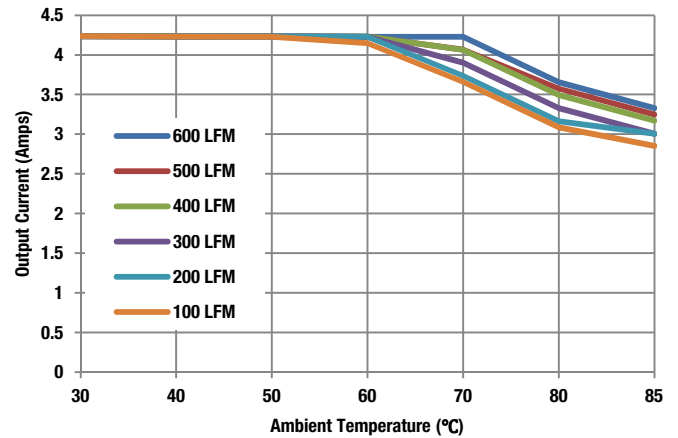

Figure 32 Maximum Current Temperature Derating (Vin = 57.6V)

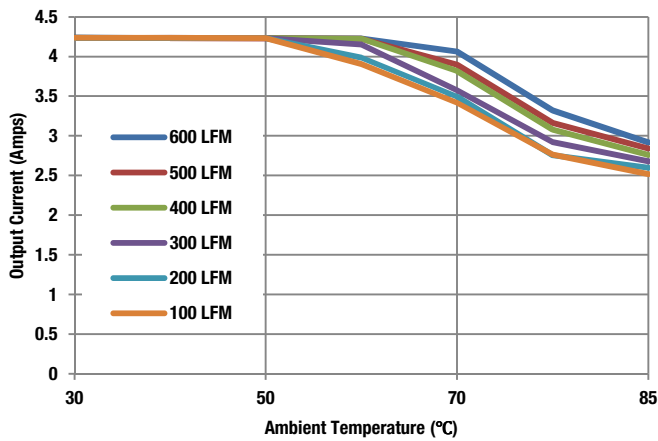

Figure 33 Maximum Current Temperature Derating (Vin = 110V)

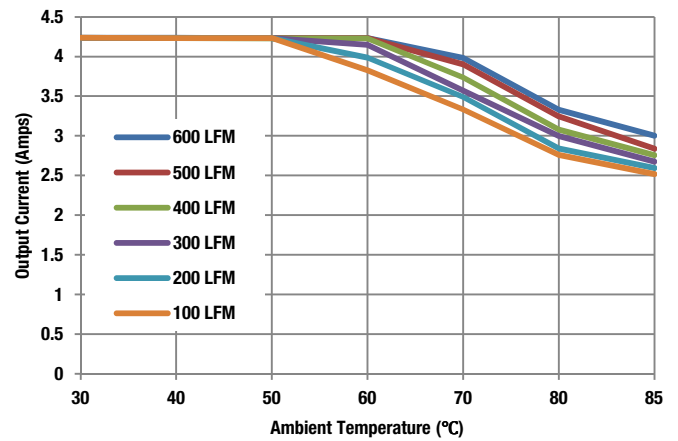

Figure 34 Maximum Current Temperature Derating (Vin = 110V)

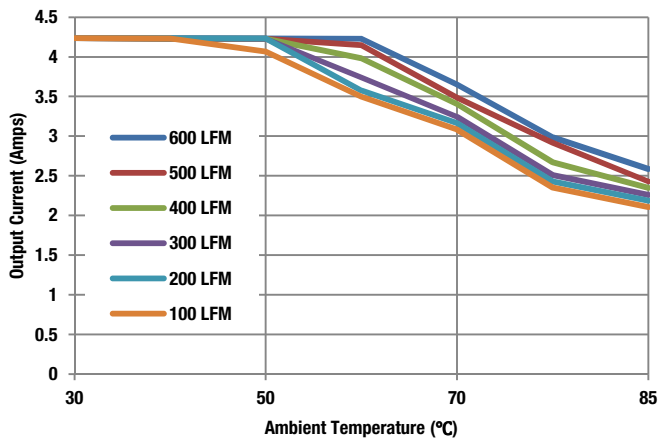

Figure 35 Maximum Current Derating (Vin = 160V)

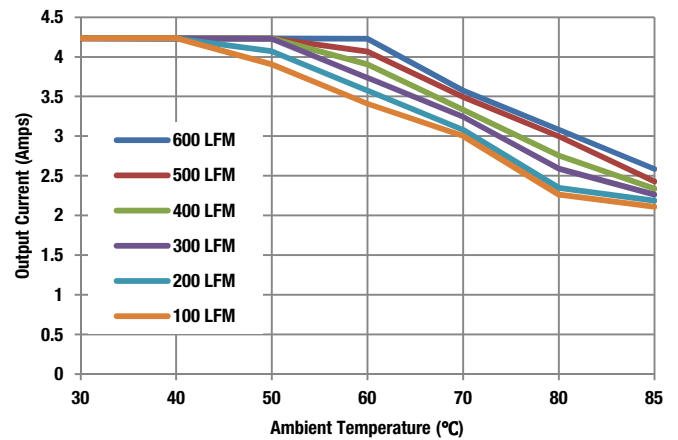

Figure 36 Maximum Current Derating (Vin = 160V)



# 100 Watt EBM Series Encased DC/DC Converter



## MECHANICAL SPECIFICATIONS: SLOTTED-FLANGED BASEPLATE

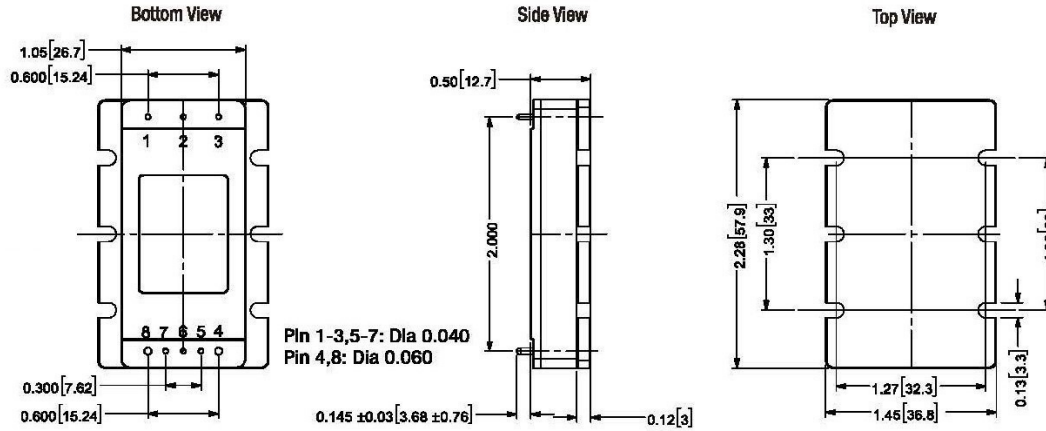

### Top View

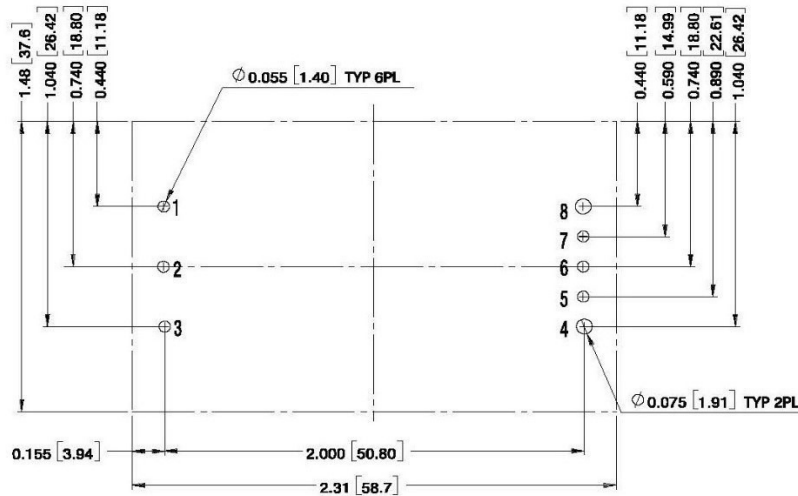

### Recommended Footprint for Slotted / Flanged Baseplate

Dimensions are in inches (mm) shown for ref. only.

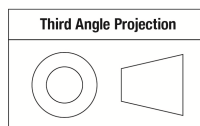

Tolerances (unless otherwise specified):  
.XX ± 0.02 (0.5)  
.XXX ± 0.010 (0.25)  
Angles ± 1°

Components are shown for reference only  
and may vary between units.

INPUT/OUTPUT CONNECTIONS	
Pin	Function
1	Vin(+)
2	On/Off Control
3	Vin(-)
4	Vout(-)
5	Sense(-)
6	Trim
7	Sense(+)
8	Vout(+)

# 100 Watt EBM Series Encased DC/DC Converter



## MECHANICAL SPECIFICATIONS: BASEPLATE WITHOUT FLANGE

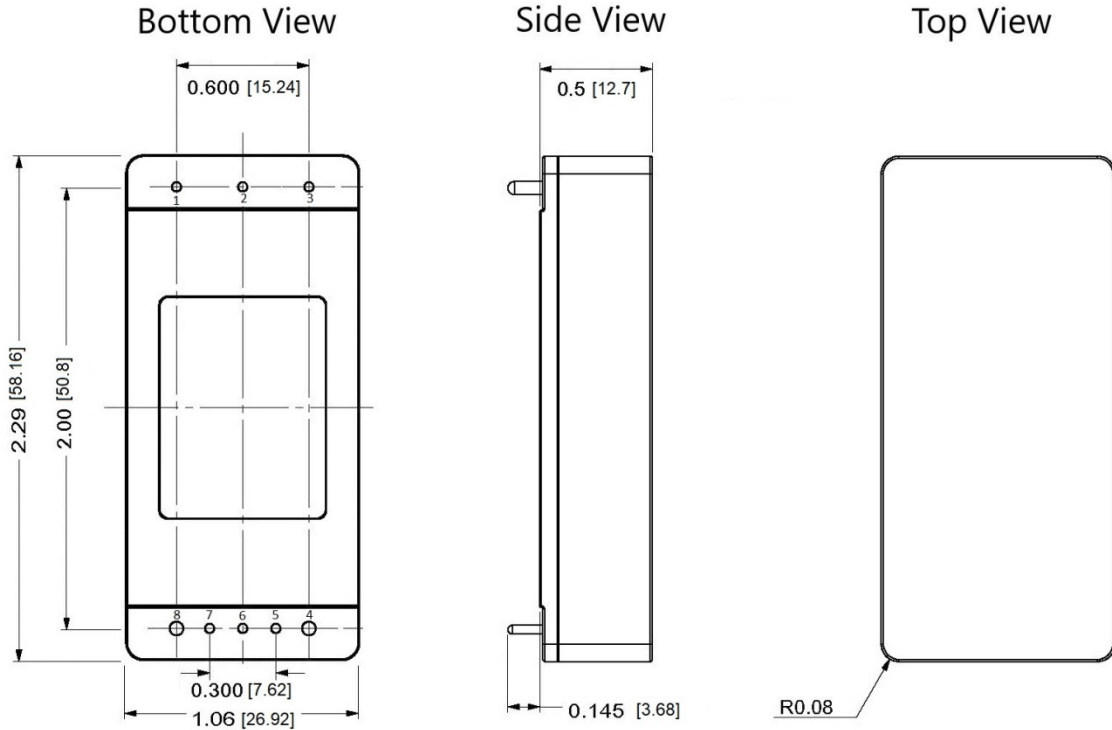

Dimensions are in inches (mm) shown for ref. only.

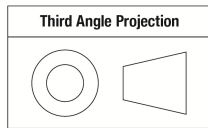

Tolerances (unless otherwise specified):  
 .XX ± 0.02 (0.5)  
 .XXX ± 0.010 (0.25)  
 Angles ± 1°

Components are shown for reference only  
 and may vary between units.

INPUT/OUTPUT CONNECTIONS	
Pin	Function
1	Vin(+)
2	On/Off Control
3	Vin(-)
4	Vout(-)
5	Sense(-)
6	Trim
7	Sense(+)
8	Vout(+)

# 100 Watt EBM Series Encased DC/DC Converter



## SHIPPING TRAYS AND BOX DIMENSIONS

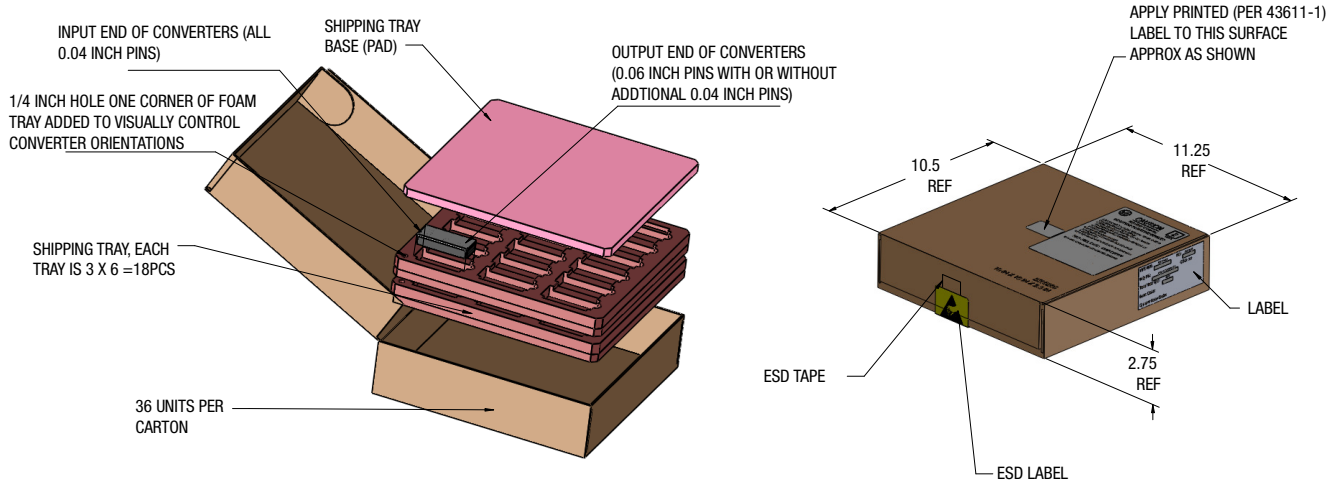

## SHIPPING TRAY DIMENSIONS

Material: Low density closed cell polyethylene static dissipative foam

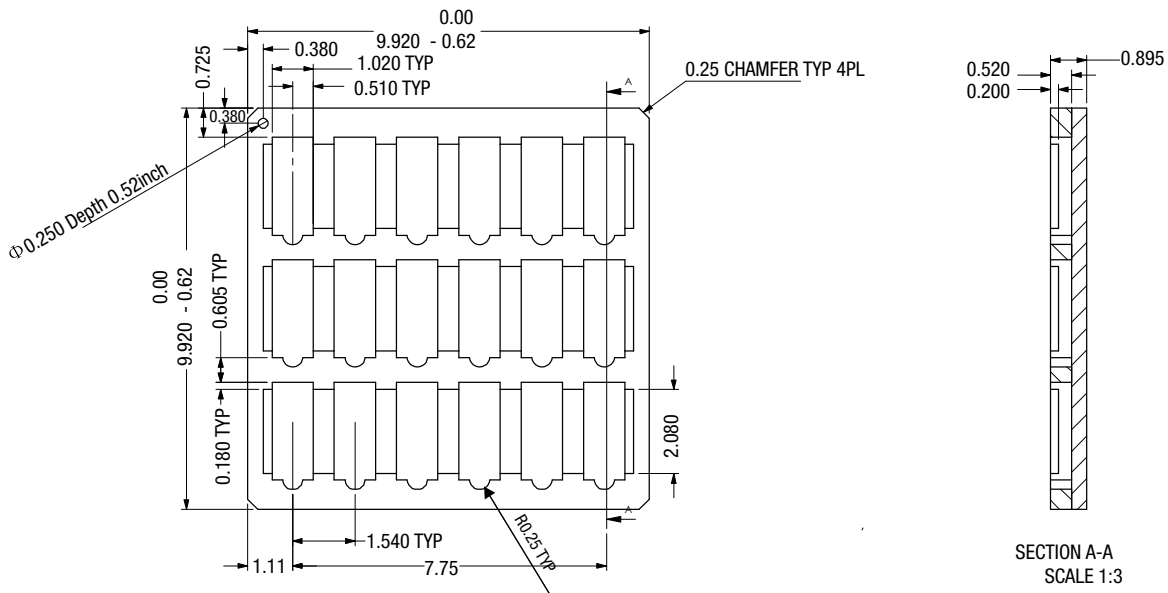

Dimensions are in millimeters  
Tolerance (unless otherwise specified)  
.xx ± 0.5  
.xxx ± 0.25  
Angles ± 2°

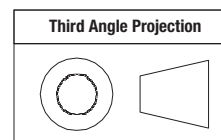

# 100 Watt EBM Series Encased DC/DC Converter



## STANDARDS COMPLIANCE

Parameter	Notes
EN 60950-1/A12:2011	Reinforced insulation
UL 60950-1/R:2011-12	
CAN/CSA-C22.2 No. 60950-1/A1:2011	
IEC 61000-4-2	ESD test, 8 kV - NP, 15 kV air - NP (Normal Performance)
Note: An external input fuse must always be used to meet these safety requirements.	

## ENVIRONMENTAL QUALIFICATION TESTING

Parameter	# Units	Test Conditions
Vibration	15	EN 61373:1999 Category I, Class B, Body mounted
Mechanical Shock	15	EN 61373:1999 Category I, Class B, Body mounted
DMTBF(Life Test)	60	Vin nom , units at derating point,101days
Temperature Cycling Test( TCT)	15	-40 °C to 125 °C, unit temp. ramp 15 °C/min.,500cycles
Power and Temperature Cycling Test (PTCT)	5	Temperature operating = min to max, Vin = min to max, Load=50% of rated maximum,100cycles
Temperature ,Humidity and Bias(THB)	15	85 °C85RH,Vin=max, Load=min load,1072Hour(72hours with a pre-conditioning soak, unpowered)
Damp heat test, cyclic	15	EN60068-2-30: Temperatures: + 55 °C and + 25 °C; Number of cycles: 2 (respiration effect);Time: 2 x 24 hours; Relative Humidity: 95%
Dry heat test	5	EN60068-2-2, Vin=nom line, Full load, 85°C for 6 hours.
High Temperature Operating Bias(HTOB)	15	Vin=min to max ,95% rated load, units at derating point,500hours
Low Temperature operating	5	Vin=nom line, Full load,-40°C for 2 hours.
Highly Accelerated Life Test(HALT)	5	High temperature limits, low temperature limits, Vibration limits, Combined Environmental Tests.
EMI	3	Class A in CISPR 22 or IEC62236-3-2(GB/T 24338.4)
ESD	3	IEC 6100-4-2: +/-8kv contact discharge / +/-15kv air discharge
Surge Protection	3	EN50121-3-2
Solderability	15Pins	MIL-STD-883, method 2003 (IPC/EIA/JEDEC J-SID-002B)

# 100 Watt EBM Series Encased DC/DC Converter



## Technical Notes

### On/Off Control

The input-side, remote On/Off Control function (pin 2) can be ordered to operate with either logic type:

Negative (“N” suffix): Negative-logic devices are off when pin 2 is left open (or pulled high, applying +3.5V to +13V), and on when pin 2 is pulled low (0 to 0.8V) with respect to –Input as shown in Figure 37.

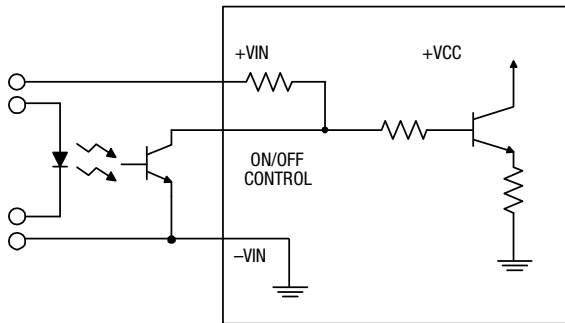

Figure 37. Driving the Negative Logic On/Off Control Pin

Dynamic control of the remote on/off function is best accomplished with a mechanical relay or an open-collector/open-drain drive circuit (optically isolated if appropriate). The drive circuit should be able to sink appropriate current (see Performance Specifications) when activated and withstand appropriate voltage when deactivated. Applying an external voltage to pin 2 when no input power is applied to the converter can cause permanent damage to the converter.

### Input Fusing

Certain applications and/or safety agencies may require fuses at the inputs of power conversion components. Fuses should also be used when there is the possibility of sustained input voltage reversal which is not current-limited. For greatest safety, we recommend a fast blow fuse installed in the ungrounded input supply line.

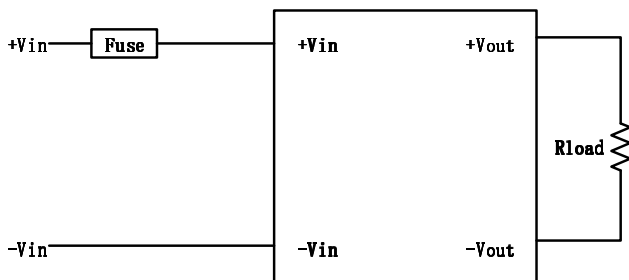

Figure 38. Input Fusing

### Input Under-Voltage Shutdown and Start-Up Threshold

Under normal start-up conditions, converters will not begin to regulate properly until the rising input voltage exceeds and remains at the Start-Up Threshold Voltage (see Specifications). Once operating, converters will not turn off until the input voltage drops below the Under-Voltage Shutdown Limit. Subsequent restart will not occur until the input voltage rises again above the Start-Up Threshold. This built-in hysteresis prevents any unstable on/off operation at a single input voltage.

### Start-Up Time

Assuming that the output current is set at the rated maximum, the Vin to Vout Start-Up Time (see Specifications) is the time interval between the point when the rising input voltage crosses the Start-Up Threshold and the fully loaded output voltage enters and remains within its specified

accuracy band. Actual measured times will vary with input source impedance, external input capacitance, input voltage slew rate and final value of the input voltage as it appears at the converter.

These converters include a soft start circuit to moderate the duty cycle of its PWM controller at power up, thereby limiting the input inrush current.

The On/Off Remote Control interval from On command to Vout (final  $\pm 5\%$ ) assumes that the converter already has its input voltage stabilized above the Start-Up Threshold before the On command. The interval is measured from the On command until the output enters and remains within its specified accuracy band. The specification assumes that the output is fully loaded at maximum rated current. Similar conditions apply to the On to Vout regulated specification such as external load capacitance and soft start circuitry.

### Recommended Input Filtering

The user must assure that the input source has low AC impedance to provide dynamic stability and that the input supply has little or no inductive content, including long distributed wiring to a remote power supply. The converter will operate with no additional external capacitance if these conditions are met.

For best performance, we recommend installing a low-ESR capacitor immediately adjacent to the converter’s input terminals. The capacitor should be a ceramic type such as the Murata GRM32 series or a polymer type. Make sure that the input terminals do not go below the undervoltage shutdown voltage at all times. More input bulk capacitance may be added in parallel (either electrolytic or tantalum) if needed.

### Recommended Output Filtering

The converter will achieve its rated output ripple and noise with no additional external capacitor. However, the user may install more external output capacitance to reduce the ripple even further or for improved dynamic response. Again, use low-ESR ceramic (Murata GRM32 series) or polymer capacitors. Mount these close to the converter. Measure the output ripple under your load conditions.

Use only as much capacitance as required to achieve your ripple and noise objectives. Excessive capacitance can make step load recovery sluggish or possibly introduce instability. Do not exceed the maximum rated output capacitance listed in the specifications.

### Input Ripple Current and Output Noise

All models in this converter series are tested and specified for input reflected ripple current and output noise using designated external input/output components, circuits and layout as shown in the figures below. The Cbus and Lbus components simulate a typical DC voltage bus.

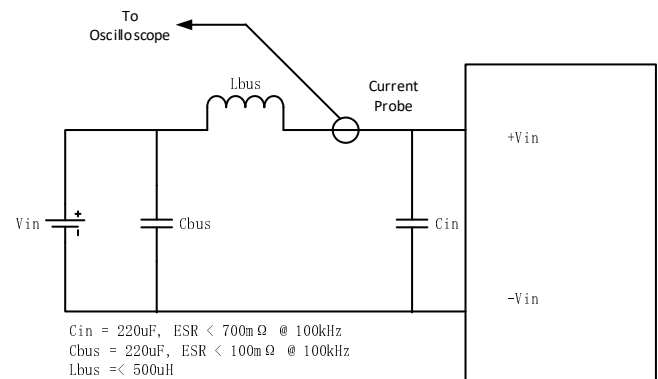
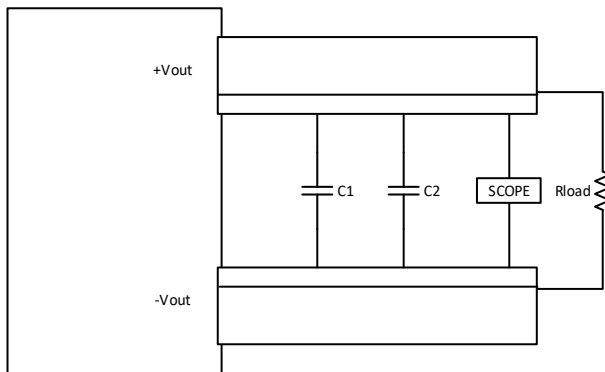

Figure 39. Measuring Input Ripple Current

# 100 Watt EBM Series Encased DC/DC Converter



C1 = 1 $\mu$ F; C2 = 10 $\mu$ F  
LOAD 2-3 INCHES(51-76mm) FROM MODULE

Figure 40 Measuring Output Ripple and Noise (PARD)

## Minimum Output Loading Requirements

All models regulate within specification and are stable under no load to full load conditions. Operation under no load might however slightly increase output ripple and noise.

## Thermal Shutdown

To prevent many over temperature problems and damage, these converters include thermal shutdown circuitry. If environmental conditions cause the temperature of the DC-DC's to rise above the Operating Temperature Range up to the shutdown temperature, an on-board electronic temperature sensor will power down the unit. When the temperature decreases below the turn-on threshold, the converter will automatically restart. There is a small amount of hysteresis to prevent rapid on/off cycling.

**CAUTION:** If you operate too close to the thermal limits, the converter may shut down suddenly without warning. Be sure to thoroughly test your application to avoid unplanned thermal shutdown.

## Temperature Derating Curves

The graphs in this data sheet illustrate typical operation under a variety of conditions. The Derating curves show the maximum continuous ambient air temperature and decreasing maximum output current which is acceptable under increasing forced airflow measured in Linear Feet per Minute ("LFM"). Note that these are AVERAGE measurements. The converter will accept brief increases in current or reduced airflow as long as the average is not exceeded.

Note that the temperatures are of the ambient airflow, not the converter itself which is obviously running at higher temperature than the outside air.

Calex makes Characterization measurements in a closed cycle wind tunnel with calibrated airflow. We use both thermocouples and an infrared camera system to observe thermal performance. As a practical matter, it is quite difficult to insert an anemometer to precisely measure airflow in most applications. Sometimes it is possible to estimate the effective airflow if you thoroughly understand the enclosure geometry, entry/exit orifice areas and the fan flow rate specifications.

**CAUTION:** If you exceed these Derating guidelines, the converter may have an unplanned Over Temperature shut down. Also, these graphs are all collected near Sea Level altitude. Be sure to reduce the derating for higher altitude.

## Output Fusing

The converter is extensively protected against current, voltage and temperature extremes. However your output application circuit may need additional protection. In the extremely unlikely event of output circuit failure, excessive voltage could be applied to your circuit. Consider using an appropriate fuse in series with the output.

## Output Current Limiting

Current limiting inception is defined as the point at which full power falls below the rated tolerance. See the Performance/Functional Specifications. Note particularly that the output current may briefly rise above its rated value in normal operation as long as the average output power is not exceeded. This enhances reliability and continued operation of your application. If the output current is too high, the converter will enter the short circuit condition.

## Output Short Circuit Condition

When a converter is in current-limit mode, the output voltage will drop as the output current demand increases. If the output voltage drops too low (approximately 97% of nominal output voltage for most models), the PWM controller will shut down. Following a time-out period, the PWM will restart, causing the output voltage to begin rising to its appropriate value. If the short-circuit condition persists, another shutdown cycle will initiate. This rapid on/off cycling is called "hiccup mode." The hiccup cycling reduces the average output current, thereby preventing excessive internal temperatures and/or component damage.

The "hiccup" system differs from older latching short circuit systems because you do not have to power down the converter to make it restart. The system will automatically restore operation as soon as the short circuit condition is removed.

## Output Capacitive Load

These converters do not require external capacitance added to achieve rated specifications. Users should only consider adding capacitance to reduce switching noise and/or to handle spike current load steps. Install only enough capacitance to achieve noise objectives. Excess external capacitance may cause degraded transient response and possible oscillation or instability.

**NOTICE:** Please use only this customer data sheet as product documentation when laying out your printed circuit boards and applying this product into your application. Do NOT use other materials as official documentation such as advertisements, product announcements, or website graphics.

We strive to have all technical data in this customer data sheet highly accurate and complete. This customer data sheet is revision-controlled and dated. The latest customer data sheet revision is normally on our website ([www.calex.com](http://www.calex.com)) for products which are fully released to Manufacturing. Please be especially careful using any data sheets labeled "Preliminary" since data may change without notice.