



SWITCH FUNCTION	
POS. 1	POS. 2
	
OFF	(ON)
OPEN	1-2

(ON) = MOMENTARY



PANEL CUTOUT  
MAX. PANEL THICKNESS 6.0mm

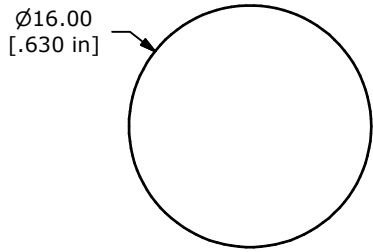
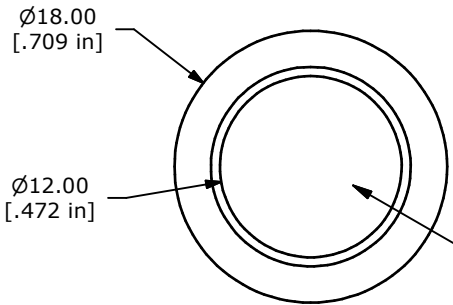

FLAT ACTUATOR  
BLACK ANODIZED FINISH

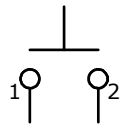
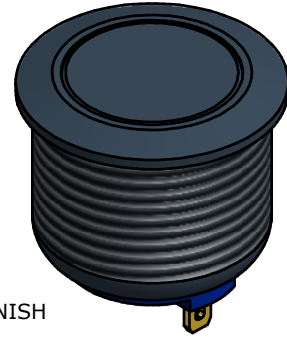

CIRCUIT: SPST

BODY  
BLACK ANODIZED FINISH

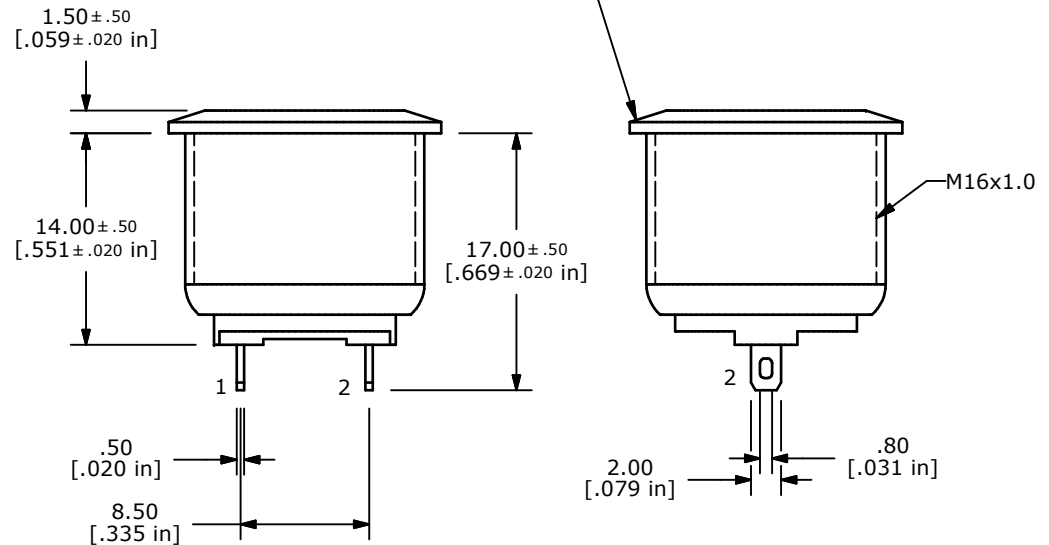

NOTE:

1. ALL DIMENSIONS IN MM [INCH]
2. GENERAL TOLERANCE: X.X±0.4  
X.XX±0.25
3. TERMINAL NUMBERS FOR REF ONLY
4. CONTACT MATERIAL: SILVER
5. RATING: 2A 48VDC
- ▲ 6: TRAVEL: 1.5 ± 0.2mm
7. ELECTRIC LIFE: 200,000 MAKE-AND-BREAK CYCLES
8. INSULATION RESISTANCE: 1,000 MΩ MIN.
9. DIELECTRIC STRENGTH: 2,000 VAC MIN. FOR 1 MINUTE
10. CONTACT RESISTANCE: 50mΩ MAX. @ 1A 12VDC
11. OPERATING TEMP.: -20°C to 55°C
12. ▲ DENOTES CRITICAL PARAMETER.
13. INGRESS PROTECTION: IP65
- ▲ 14. HARDWARE SUPPLIED: O-RING AND HEXNUT
15. 2002/95/EC (ROHS) COMPLIANT



TITLE PV2F24011

A	21607	INITIAL RELEASE	10/10/14	EBP
REV	PCR NO	DESCRIPTION	DATE	BY

THE INFORMATION CONTAINED IN THIS DOCUMENT IS PROPRIETARY TO E-SWITCH AND IS NOT TO BE COPIED OR TRANSFERRED

SCALE	DATE 10/10/2014	DR EBP	DWG 52-PV2F24011	REV A
-------	--------------------	-----------	---------------------	----------