

Preface

The MTCH2120 Evaluation Kit (EV64Z42A) is a hardware platform designed to assess the capabilities of the MTCH2120 I²C-based touch turnkey microcontroller. The MTCH2120 evaluation board incorporates 12 touch sensors of different shapes and sizes, support for driven shield (+) to evaluate the robust noise performance and moisture tolerance. The board also features an on-board host microcontroller, as well as the ability to connect to an external host. The MTCH2120 device on the board can be fully configured using the MPLAB[®] Data Visualizer touch plugin. Via the I²C interface, the MTCH2120 is very flexible and configurable to meet the application requirements.

Figure 1. MTCH2120 Evaluation Kit

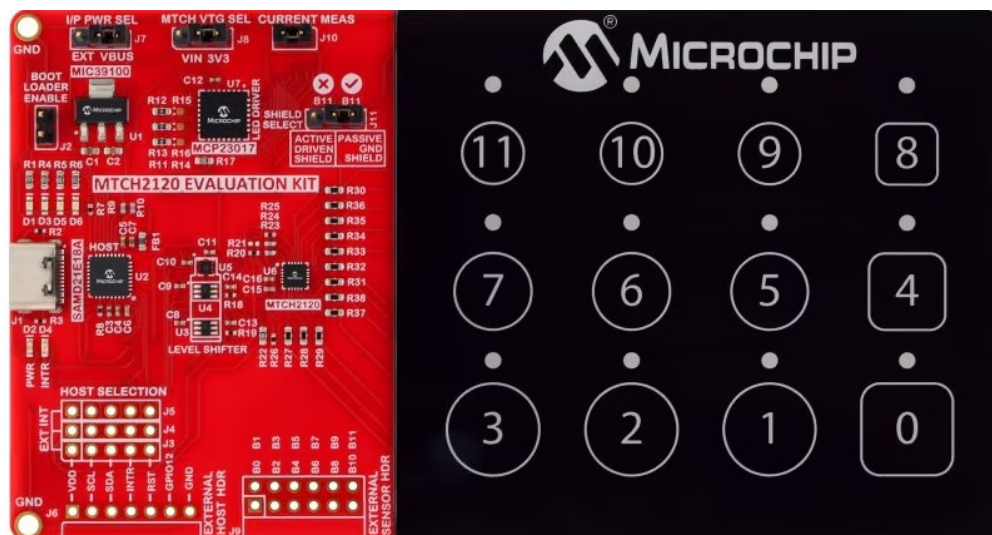

- [MTCH2120 Evaluation Kit website](#) – Kit information, latest user guide, and design documentation
- [MTCH2120 website](#) – Find documentation, data sheets, sample, and purchase microcontrollers
- [MTCH2120 Evaluation Kit on Microchip Direct](#) – Purchase this kit on Microchip Direct
- [MTCH2120 Evaluation Kit Schematics](#) – Board schematics
- [MTCH2120 Evaluation Kit PCB CAD Files \(Altium\)](#) – Altium PCB design project files
- [MTCH2120 Evaluation Kit Design Documentation](#) – Production files
- [MTCH2120 Example Project on MPLAB DISCOVER](#) – MTCH2120-related example project
- [MTCH2120 Evaluation Kit Host firmware upgrades](#) – Host firmware location

Table of Contents

Preface.....	1
1. MTCH2120 Key Features.....	3
1.1. Board Features.....	3
1.2. Board Overview.....	4
1.3. Block Diagram.....	4
2. Getting Started.....	5
2.1. MPLAB Data Visualizer for MTCH2120 Evaluation Kit.....	5
2.2. Electrode Design.....	6
2.3. Touch Sensor.....	7
3. Board Configuration.....	8
3.1. Shield Selection.....	8
3.2. External Host MCU Selection	8
3.3. External Touch Evaluation.....	9
4. Host MCU.....	10
4.1. External MTCH2120 Evaluation.....	10
4.2. Procedure to Update the On-board Host MCU.....	10
5. LED Status Information.....	11
6. Hardware Revision History and Known Issues.....	12
6.1. Identifying Product ID and Revision.....	12
7. Document Revision History.....	13
Microchip Information.....	14
Trademarks.....	14
Legal Notice.....	14
Microchip Devices Code Protection Feature.....	14
Product Page Links.....	15

1. MTCH2120 Key Features

The Microchip MTCH2120, Capacitive Touch turnkey controller, equipped with an I²C (Inter-Integrated Circuit) interface, enables the application to integrate robust, low-power, water-resistant touch detection and proximity sensing. This device includes up to 12 capacitive touch channels with configurable Driven Shield(+) functionality.

- Capacitive Touch Sensing
- High Signal Noise Ratio (SNR)
- Configurable Through I²C Bus
- Adjustable Sensitivity
- Device Configuration Support through MPLAB Data Visualizer Plugin
- Ability to Store Complete Configuration in Non-volatile Memory
- Host Controlled Device Configuration Check
- MPLAB[®] Code Configurator (MCC) plugin to configure Microchip MCUs/MPUs as hosts
- Multi-Stage Active Noise Suppression Filters
- Automatic Environmental Compensation
- Water Tolerant Touch
- Easy tune (the ability to use touch buttons w/o tuning)
- Low Power with Flexible Configuration
- Lump Option with Smart Drift
- Configurable GPIO
- Support a Wide Range of Sensor Shapes and Sizes
- Interrupt pin for Touch Status change
- Option to Disable or Suspend Sensor
- Enable or Disable Single-Button Mode
- Option to Save Configuration
- Brown-Out Protection
- Operating Voltage Range: 3-5V
- Operating Temperature: -40°C to +105°C
- Configurable I/O Expander via I²C

1.1. Board Features

- MTCH2120 with 12 touch buttons on-board
 - Shield Selection between Driven shield and Ground shield
 - Option to connect External Touch Sensor
- [SAMD21E18A](#) Host Microcontroller
 - Host programmable via USB Mass Storage Boot Loader
 - Enumerates as USB CDC for connecting with MPLAB[®] Data Visualizer touch plugin
- Option to use the external host MCU with the on-board MTCH2120
- Option to use on-board the SAMD21 Host MCU with External MTCH2120
- Power Options:
 - External or USB power supply

- MTCH2120 voltage selection 5V/3.3V
- Current measurement header
- LEDs:
 - One Green LED for power indication
 - One Red LED for interrupt status from MTCH2120
 - Four blue LEDs for host MCU status
 - Touch Status red LED for each touch button
- USB Type-C® Connector

1.2. Board Overview

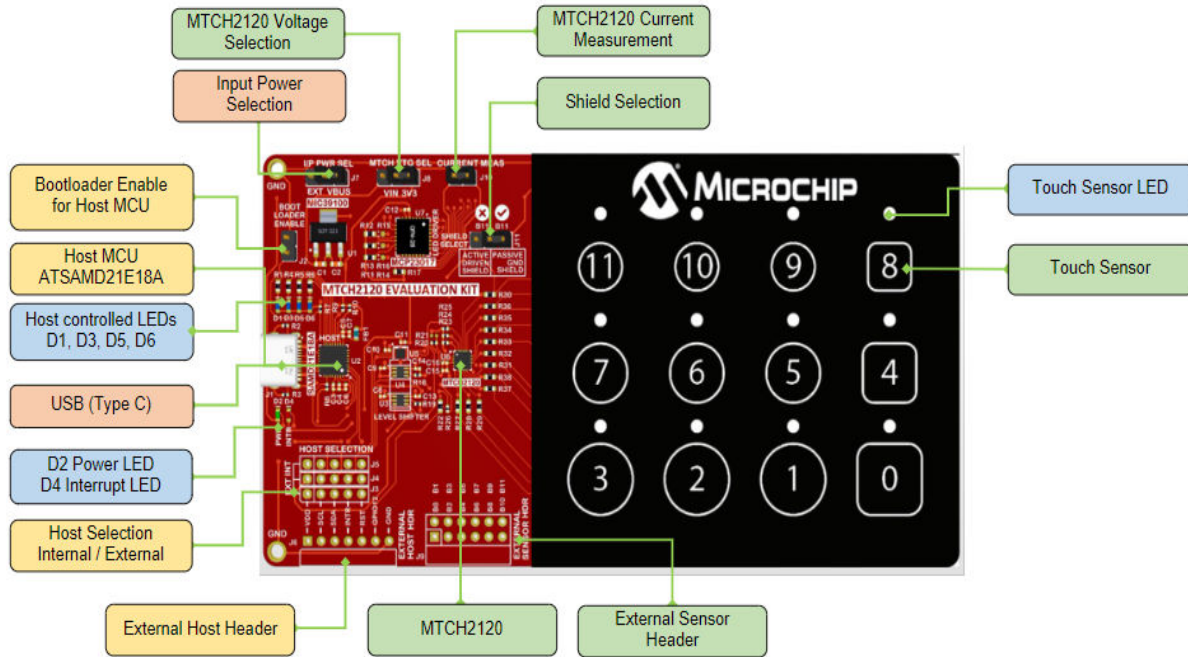

1.3. Block Diagram

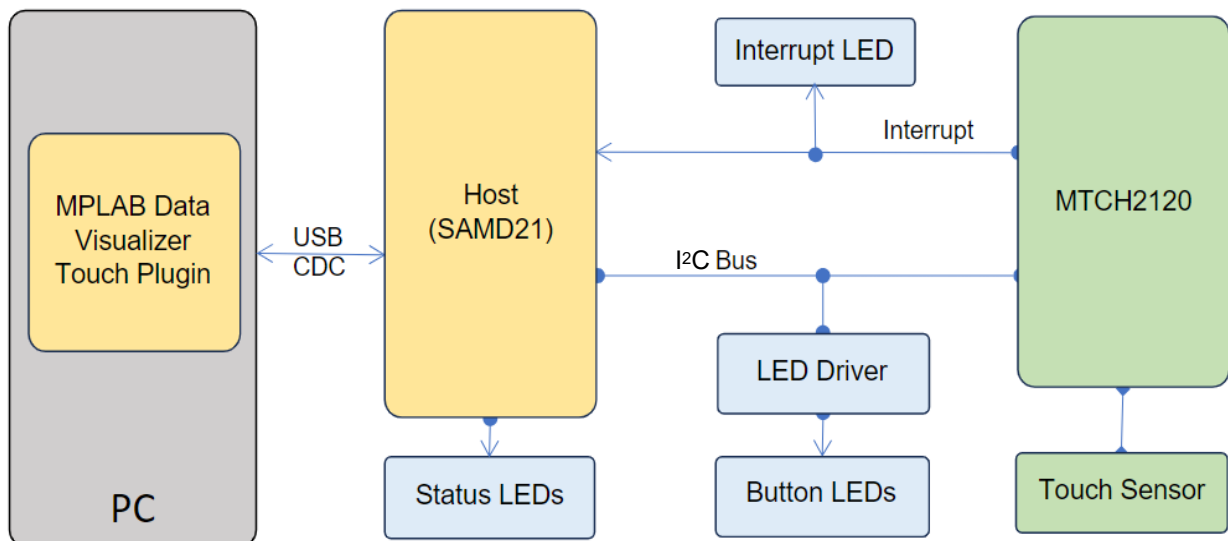

2. Getting Started

The MTCH2120 Evaluation Kit functions as a standalone unit featuring twelve buttons. The kit can be powered by connecting the USB cable to the USB TYPE-C Connector and a PC. The USB interface also acts as a COM port, which allows the host MCU to interact with MPLAB Data Visualizer Touch Plugin. The default configuration of the kit allows the user to start using the touch buttons out-of-the-box. Additionally, the user can modify various parameters of MTCH2120 using the MPLAB Data Visualizer Touch Plugin.

2.1. MPLAB Data Visualizer for MTCH2120 Evaluation Kit

The MPLAB Data Visualizer is a software application designed to process and visualize data from an active embedded target. It is available as a plugin for MPLAB® X IDE and as a standalone program.

Find the installation procedure for the MPLAB Data Visualizer in the [MPLAB®-Data-Visualizer-Installation](#).

The MPLAB Touch Plugin is required to view and edit touch-tuning data. The installation procedure for the MPLAB Touch Plugin is available in the [MPLAB®-Touch-Plugin-Installation](#).

The MPLAB Touch Plugin communicates with the host MCU via a USB CDC interface. Tuning data from the MTCH2120 device can be viewed and configured using the MPLAB Data Visualizer Touch Plugin.

To connect the MTCH2120 Evaluation Kit in the MPLAB Data Visualizer, follow these steps:

1. Connect the MTCH2120 Evaluation Kit to your PC using a Type C USB cable.
2. Open the MPLAB Data Visualizer.
3. Identify the COM port for the MTCH2120 and set the baud rate to 115200.

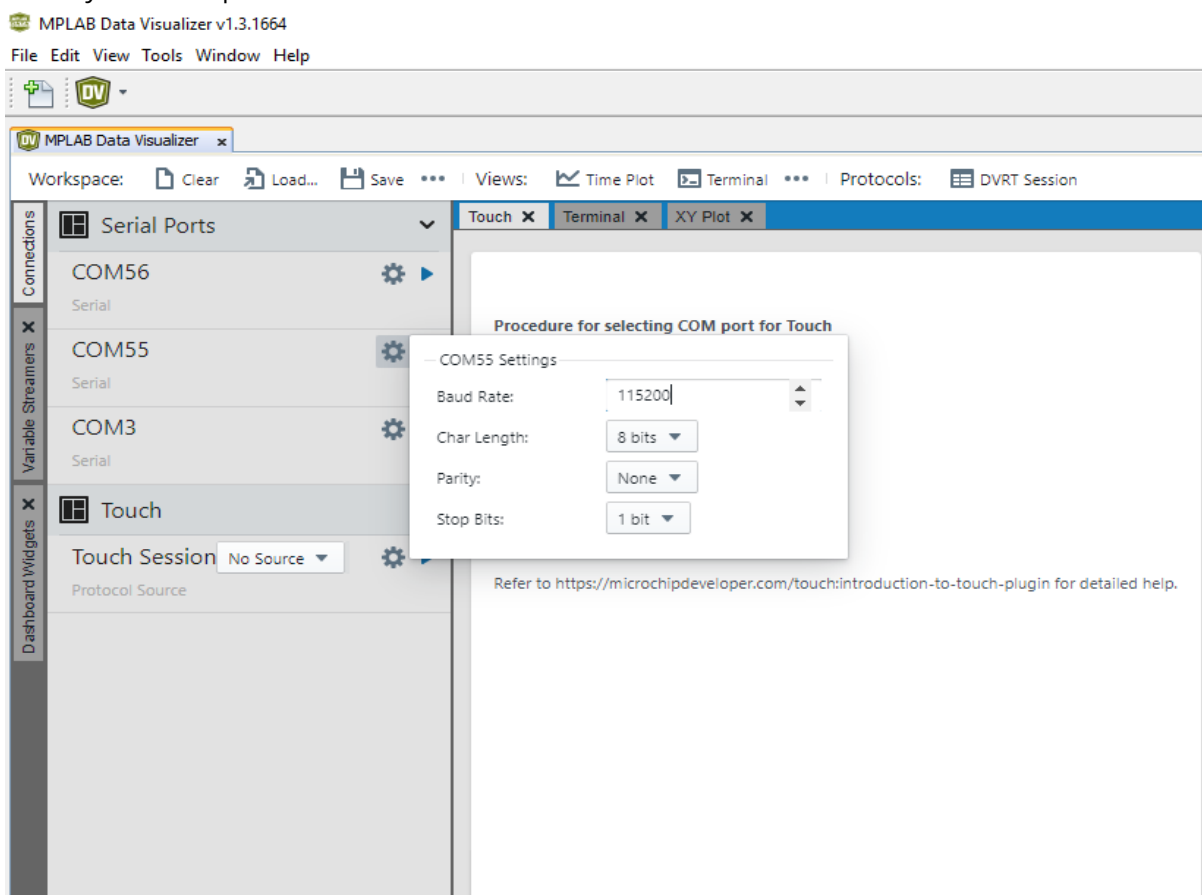

- Click the Play button for the COM port of the MTCH2120 under the Serial Port section.
- Select the MTCH2120 COM port in the Touch Session and click the Play button.

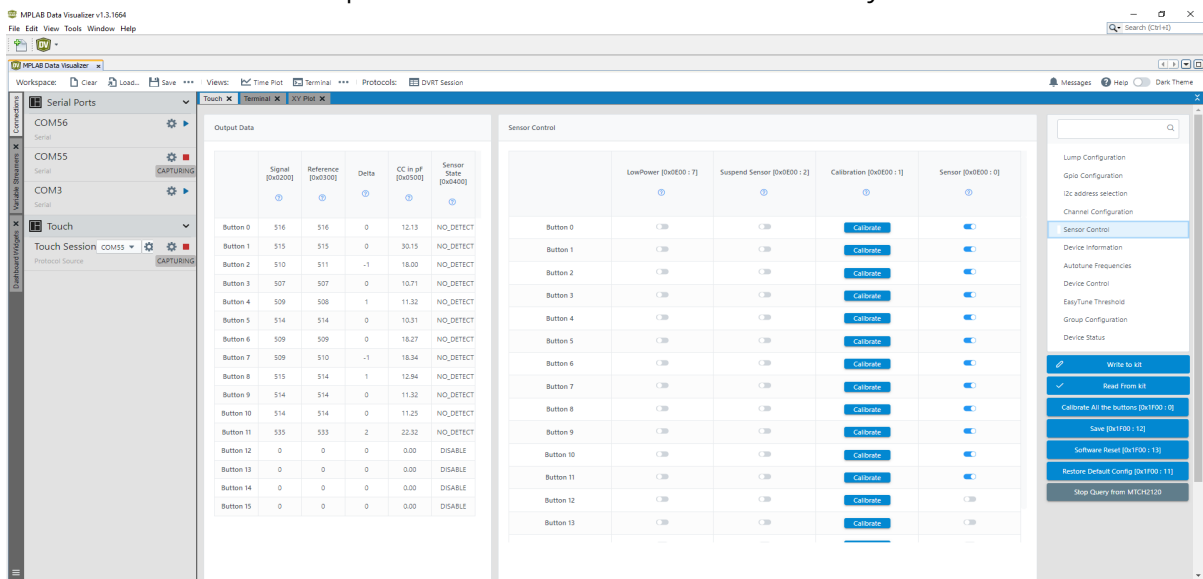

Note: Refer to the MTCH2120 Data sheet for device configuration and parameters information.

2.2. Electrode Design

The twelve on-board electrodes are designed as standard touch buttons with shield options. The Buttons are designed in different sizes to explore various real-world application scenarios. The electrode overlay is 1 mm the thickness of SABIC™ LEXAN™ 8010 polycarbonate film, secured with 3M™ Adhesive Transfer Tape 467.

Touch sensor generation using the Altium tool is available. For more details, check the [Touch Sensor Altium Designer® Plugin](#).

The schematic and layout for the sensors follow the design rules provided in the Microchip application note: [AN2934, "Capacitive Touch Sensor Design Guide"\(DS0002934\)](#).

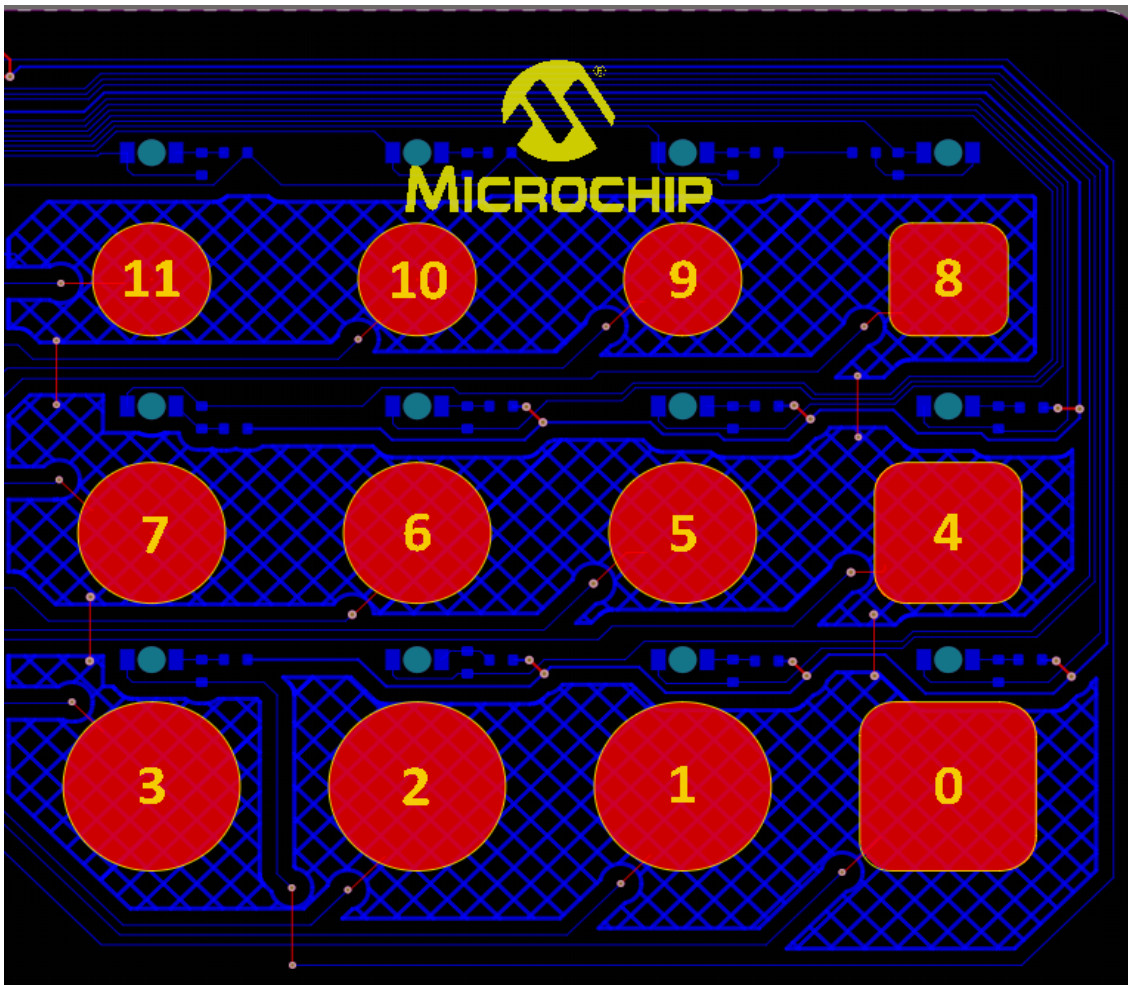

Note:

Complete CAD files for the MTCH2120 Evaluation Kit board are available at the Microchip web site: <https://www.microchip.com/en-us/development-tool/EV64Z42A>.

2.3. Touch Sensor

The sensor electrodes are connected to the BUTTOnx pins of the MTCH2120 touch controller via series resistors to reduce electromagnetic interference (EMI) and electromagnetic compatibility (EMC), following the guidelines of the [AN2924 "Capacitive Touch Sensor Design Guide" application note](#).

The series resistors used in this evaluation kit are 100 k Ω each, with a variance of 10-200 k Ω in a real-world application, depending on the sensor capacitance and desired level of EMC performance. For more details, refer to the "Capacitive Touch Sensor Design Guide" application note.

The MTCH2120 Evaluation Kit has been tested against conducted immunity according to IEC 61000-4-6 and passes the test at the highest level 3 (10 V_{rms} Conducted immunity noise). No False touch is observed, and touch detection works as expected. The default MTCH2120 parameters are used for the test. Refer to the MTCH2120 Data sheet for default parameters.

3. Board Configuration

The MTC2120 Evaluation Kit provides the following configuration options at the board level. Use a custom application or connect to the MPLAB Data Visualizer Touch Plugin to configure other parameters through the I2C host Interface. Refer to the [MCC Harmony Touch Host Configurator](#) for instructions on configuring the host application for Microchip MCUs/MPUs implementing the protocol.

3.1. Shield Selection

To get more information on using a shield in a touch application, refer to [Shielding](#).

MTCH2120 can select a shield as a passive GND Shield or an active Driven Shield. By default, the passive GND Shield is selected. To select the Active Driven Shield, follow the steps below:

- Disable Button 11 using the Data Visualizer in the sensor control section
- Enable the Driven Shield using the Data Visualizer in the device control section
- Save the updated configuration to the MTCH2120 device by clicking the Save button
- Reset the device by clicking the "Software Reset" button. Or reset the device by power cycling the kit
- Insert the jumper into pins 1 and 2 of J11

When the Active Driven Shield option is selected, Button 11 becomes non-operational. The LED for Button 11 will toggle to indicate this status.

3.2. External Host MCU Selection

The MTCH2120 Evaluation Kit has an on-board host MCU (SAM21E18A) to communicate with the MTCH2120 via I²C. The Kit can use the on-board host or an external host.

Follow the following steps to connect the on-board MTCH2120 with an external host MCU. By default the kit is connected to on-board host MCU. To connect the external host, follow the steps below:

1. Modify the PCB jumper, which is ordinarily closed between J5 and J4, by cutting it.

Figure 3-1. PCB Bottom Side

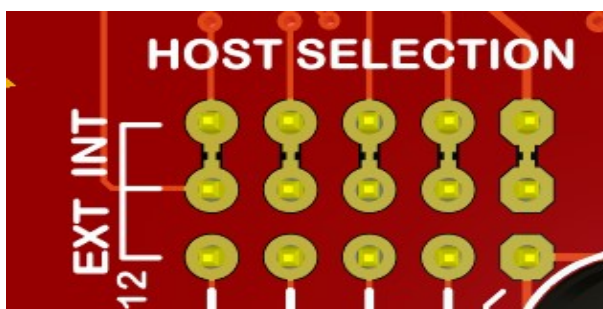

2. Solder the solder pad between J4 and J3. Alternatively header can also be used for flexibility.

Figure 3-2. PCB Top Side

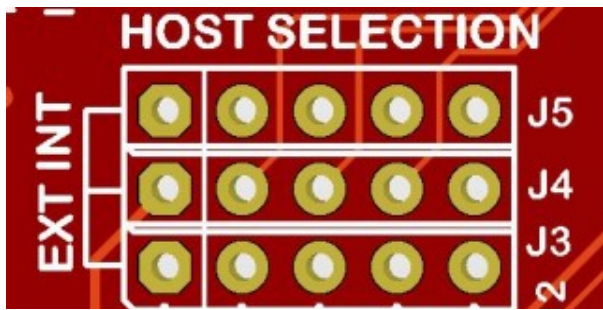

3. Mount Header J6 and connect to the external host board.

3.3. External Touch Evaluation

The following steps are required for connecting the on-board MTCH2120 with an external sensor board:

- Remove the touch sensor connected to Resistor R27 - R38
- Mount Header J9 and connect to the external touch sensor board

Note: On-board touch sensor operation. Resistors R27-R38 must be mounted.

4. Host MCU

The SAMD21E18A device is utilized as the host MCU for the MTCH2120 EVK. The host MCU is responsible for reading and writing tuning data from the MTCH2120. Additionally, the host MCU controls the LED driver to indicate button touch status.

The host MCU fetches data from the MTCH2120 device approximately every 35 milliseconds and sends the data to the Touch Plugin. Clicking the "Start Query from MTCH2120/Stop Query from MTCH2120" button in the MPLAB Data Visualizer can start or stop continuous fetching.

4.1. External MTCH2120 Evaluation

The following steps are required for connecting the on-board host MCU with an external MTCH2120:

- Ensure the voltage of the external MTCH2120 does not exceed 3.3V, as the on-board host operates at 3.3V
- Modify the PCB jumper by cutting the connection between J5 and J4, which is typically closed
- Install Header J5 and connect it to the external MTCH2120 board

4.2. Procedure to Update the On-board Host MCU

The host MCU can be updated by entering into the Boot loader Mode. The following steps are required for updating the host MCU:

- Insert the jumper into Header J2
- Power OFF and ON the board by removing and reconnecting the USB cable
- Remove the jumper from Header J2
- LEDs D1, D3, D5 and D6 will blink sequentially, indicating that host MCU in the Boot Loader mode
- The latest upgrades for the MTCH2120 Evaluation Kit on-board host firmware are available in [MPLAB DISCOVER](#)
- The kit enumerates the USB mass storage (like a Pen Drive) in the PC. Copy the latest host and paste it to the drive.

- LEDs D1, D3, D5 and D6 will indicate three times that the programming is successful
Note: If LEDs D1, D3, D5 and D6 are continuously ON, then the programming is unsuccessful, and the user needs to retry.

5. LED Status Information

LED	Status	Description
D2 (Green)	ON	The Evaluation Kit is powered on
D4 (Red)	Blinking	The button being touched or released
D1 (Blue)	ON	The default touch configuration is loaded onto the MTCH2120
D1 (Blue)	OFF	The user touch configuration is loaded onto the MTCH2120
D3 (Blue)	Blinking	The host MCU is communicating with the MTCH2120 device
D5 (Blue)	Blinking	The host MCU is communicating with the Touch Plugin
D6 (Blue)	ON	The saved configuration in the MTCH2120 is corrupted
D1, D3, D5, and D6 (Blue)	Blinking sequentially	The host MCU is in Bootloader mode
D1, D3, D5, and D6 (Blue)	Blinking three times	Host programming is successful
D1, D3, D5, and D6 (Blue)	ON	Host programming is unsuccessful

6. Hardware Revision History and Known Issues

The Schematic Revision History page provides information about the latest board revision. The differences between previous versions and the latest revision are also available on the Revision History page.

6.1. Identifying Product ID and Revision

The revision and product identifier of the MTCH2120 Evaluation Kit can be found on the label located under the PCB. Most boards will have the identifier, revision, serial number, and manufacturing date printed in plain text as 02-nnnn\rr SN: mmmsssss [Manufacturing date], where "nnnn" is the identifier, "rr" is the revision, "mmm" is the manufacturer, and "sssss" is the serial number.

The serial number string has the following format:

"nnnnrrssssssss"

n = product identifier

r = revision

m = manufacturer

s = serial number

The product identifier for the MTCH2120 Evaluation Kit is 02-01153.

7. Document Revision History

Doc. Rev.	Date	Comments
B	11/2025	The document has been updated to provide additional details on the procedure for updating the On-board Host MCU, as well as information about the hardware revision history.
A	11/2024	Initial document release

Microchip Information

Trademarks

The “Microchip” name and logo, the “M” logo, and other names, logos, and brands are registered and unregistered trademarks of Microchip Technology Incorporated or its affiliates and/or subsidiaries in the United States and/or other countries (“Microchip Trademarks”). Information regarding Microchip Trademarks can be found at <https://www.microchip.com/en-us/about/legal-information/microchip-trademarks>.

ISBN: 979-8-3371-2258-8

Legal Notice

This publication and the information herein may be used only with Microchip products, including to design, test, and integrate Microchip products with your application. Use of this information in any other manner violates these terms. Information regarding device applications is provided only for your convenience and may be superseded by updates. It is your responsibility to ensure that your application meets with your specifications. Contact your local Microchip sales office for additional support or, obtain additional support at www.microchip.com/en-us/support/design-help/client-support-services.

THIS INFORMATION IS PROVIDED BY MICROCHIP “AS IS”. MICROCHIP MAKES NO REPRESENTATIONS OR WARRANTIES OF ANY KIND WHETHER EXPRESS OR IMPLIED, WRITTEN OR ORAL, STATUTORY OR OTHERWISE, RELATED TO THE INFORMATION INCLUDING BUT NOT LIMITED TO ANY IMPLIED WARRANTIES OF NON-INFRINGEMENT, MERCHANTABILITY, AND FITNESS FOR A PARTICULAR PURPOSE, OR WARRANTIES RELATED TO ITS CONDITION, QUALITY, OR PERFORMANCE.

IN NO EVENT WILL MICROCHIP BE LIABLE FOR ANY INDIRECT, SPECIAL, PUNITIVE, INCIDENTAL, OR CONSEQUENTIAL LOSS, DAMAGE, COST, OR EXPENSE OF ANY KIND WHATSOEVER RELATED TO THE INFORMATION OR ITS USE, HOWEVER CAUSED, EVEN IF MICROCHIP HAS BEEN ADVISED OF THE POSSIBILITY OR THE DAMAGES ARE FORESEEABLE. TO THE FULLEST EXTENT ALLOWED BY LAW, MICROCHIP’S TOTAL LIABILITY ON ALL CLAIMS IN ANY WAY RELATED TO THE INFORMATION OR ITS USE WILL NOT EXCEED THE AMOUNT OF FEES, IF ANY, THAT YOU HAVE PAID DIRECTLY TO MICROCHIP FOR THE INFORMATION.

Use of Microchip devices in life support and/or safety applications is entirely at the buyer’s risk, and the buyer agrees to defend, indemnify and hold harmless Microchip from any and all damages, claims, suits, or expenses resulting from such use. No licenses are conveyed, implicitly or otherwise, under any Microchip intellectual property rights unless otherwise stated.

Microchip Devices Code Protection Feature

Note the following details of the code protection feature on Microchip products:

- Microchip products meet the specifications contained in their particular Microchip Data Sheet.
- Microchip believes that its family of products is secure when used in the intended manner, within operating specifications, and under normal conditions.
- Microchip values and aggressively protects its intellectual property rights. Attempts to breach the code protection features of Microchip products are strictly prohibited and may violate the Digital Millennium Copyright Act.
- Neither Microchip nor any other semiconductor manufacturer can guarantee the security of its code. Code protection does not mean that we are guaranteeing the product is “unbreakable”. Code protection is constantly evolving. Microchip is committed to continuously improving the code protection features of our products.

Product Page Links

[MTCH2120](#)