

SMD PTC: Low Rho Series

OZLM Series

HF  OZLM Series – 0603 SIZE

RoHS Compliant

Product Features

- 0603 Dimension, Small surface mountable, Solid state, Faster time to trip than standard SMD devices, Lower resistance than standard SMD devices
- Full compliant with EU Directive 2011/65/EU and amending directive 2015/863

Operating (Hold Current) Range

250mA – 750mA

Maximum Voltage

6 - 9V DC (per table)



Temperature Range

-40°C to 85°C



Agency Approval

TUV (Std. EN/IEC 60738-1/60738-1-1 and EN/IEC 60730-1, Cert. R50102117)
UL Recognized Component (Std. UL1434, File E305051)



LEAD FREE = 
HALOGEN FREE = 

Electrical Characteristics (23°C)

	Part Number	Hold Current	Trip Current	Rated Voltage	Maximum Current	Typical Power	Max Time to Trip		Resistance Tolerance		Agency Approvals	
							Current	Time	Rmin	R1max		
		I _H , A	I _T , A	V _{max} , Vdc	I _{max} , A	P _d , W	A	Sec	Ohms	Ohms		
A	0ZLM0025FF2G	0.25	0.55	9	100	0.5	8.0	0.08	0.500	3.000	Y	Y
B	0ZLM0035FF2G	0.35	0.75	6	100	0.5	8.0	0.10	0.200	1.000	Y	Y
C	0ZLM0050FF2G	0.50	1.00	6	100	0.6	8.0	0.10	0.070	0.350	Y	Y
D	0ZLM0075FF2G	0.75	1.50	6	100	0.6	8.0	0.20	0.050	0.250	Y	Y

Consult manufacturer for other ratings

I_H Hold Current-maximum current at which the device will not trip in still air at 23°C.

I_T Trip current-minimum current at which the device will always trip in still air at 23°C.

I_{max} Maximum fault current device can withstand without damage at rated voltage (V_{max}).

V_{max} Maximum voltage device can withstand without damage at its rated current. (I_H MAX)

P_d Typical power dissipated by device when in tripped state in 23°C still air environment.

R_{min} Minimum device resistance at 23°C.

R_{1max} Maximum device resistance at 23°C, 1 hour after initial device trip, or after being soldered to PCB in end application.

PTC's – Basic Theory of Operation / “Tripped” Resistance Explanation

Fundamentally, a Bel PTC consists of a block of polymeric material containing conductive filler and bonded between two conductive, planar terminations.

At currents below the device IHOLD rating, AND at temperatures below 100°C, the PTC maintains a resistance value below its R1 MAX rating.

As the device's temperature approaches 130°C, either due to an increase in ambient temperature or a current exceeding its I TRIP rating, volumetric expansion of the filled polymer breaks apart the majority of conductive pathways across the terminals created by chain contact of adjacent filler particles or device resistance increases sharply by several orders of magnitude.

At the much higher “Tripped” resistance, there is just enough leakage current to allow internal heating to “hold” the device in its tripped state (around 125°C) until power is interrupted. Once power is removed, the PTC's core cools and contracts allowing conductive chains to reform and return the device to its low resistance state.

The catalog data for each device specifies a "Typical Power" value. This is the power required to exactly match the heat lost by the tripped device to its ambient surroundings at 23°C. By Ohm's Law, power can be stated as: $W = E^2/R$. Thus the approximate resistance of a “Tripped” PTC can be determined by: $R = E^2/W$, where "E" is the voltage appearing across the PTC (usually the supply's open circuit voltage), and "W" is the Typical Power value for the particular PTC.

Since the PPTC acts to maintain a constant internal temperature, its apparent resistance will change based upon applied voltage and, to a lesser degree, ambient conditions. Consider the following example....

A PTC with a Typical Power of 1 watt protecting a circuit using a 60V supply will demonstrate an apparent, tripped resistance "R" of:

$$R = 60^2/1 = 3,600 \text{ ohms}$$

This same tripped device when used to protect a 12V circuit would now present an apparent resistance of:

$$R = 12^2/1 = 144 \text{ ohms}$$

The value for Typical Power is "typical" because any physical factors that affect heat loss (such as ambient temperature or air convection) will somewhat alter the level of power that the PTC needs to maintain its internal temperature. In short, PTCs do not exhibit a constant, quantifiable tripped resistance value.

Type Time – To – Trip at 23°C

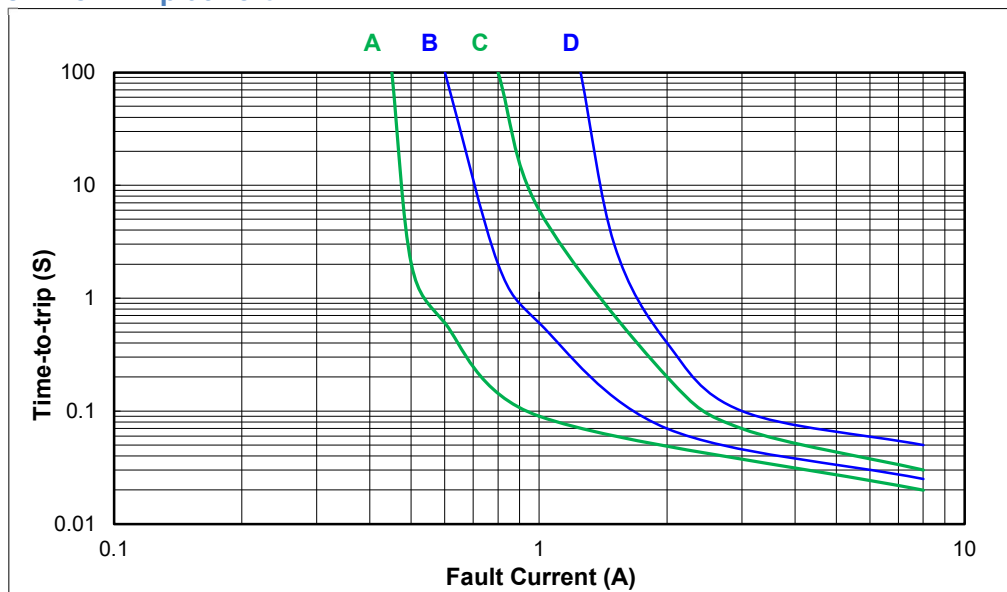

The Average Time Current Characteristic Curve and Temperature Rerating Curve are affected by a number of variables and these curves are provided for guidance only.



Specifications subject to change without notice

Bel Fuse Inc.
300 Executive Drive, Suite 300,
West Orange, NJ 07052 USA

+1 201.432.0463
Bel.US.CS@belf.com
belfuse.com/circuit-protection

Pad Layout

The dimensions in the table below provide the recommended pad layout.

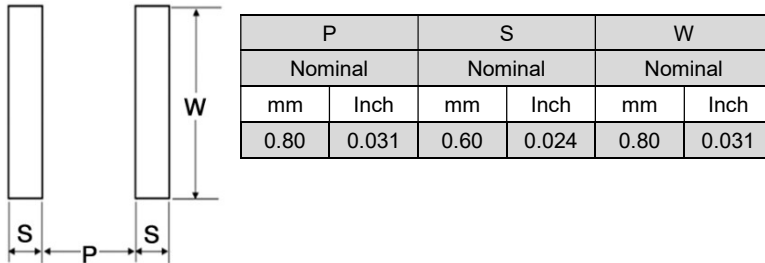

Termination Pad Materials

Pure Tin

Mechanical Dimensions and Marking

All dimensions in mm.

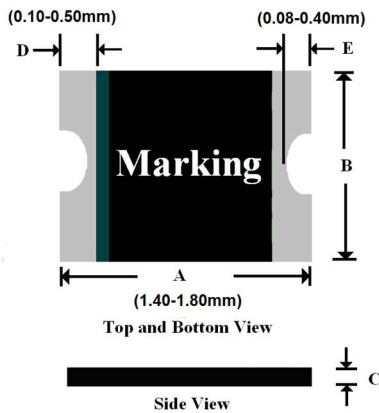

Part Number	Dimensions		Dimensions		Marking Code
	B		C		
	Min	Max	Min	Max	IH code
0ZLM0025FF2G	0.45	1.00	0.30	0.70	H
0ZLM0035FF2G	0.45	1.00	0.30	0.70	I
0ZLM0050FF2G	0.45	1.00	0.30	0.70	J
0ZLM0075FF2G	0.45	1.00	0.30	0.70	K

Temperature Derating Table

	Temperature Derating									
I Hold Value	-40	-20	0	23	30	40	50	60	70	85
0ZLM	145%	130%	115%	100%	92%	84%	77%	69%	61%	50%

Thermal Derating Curve

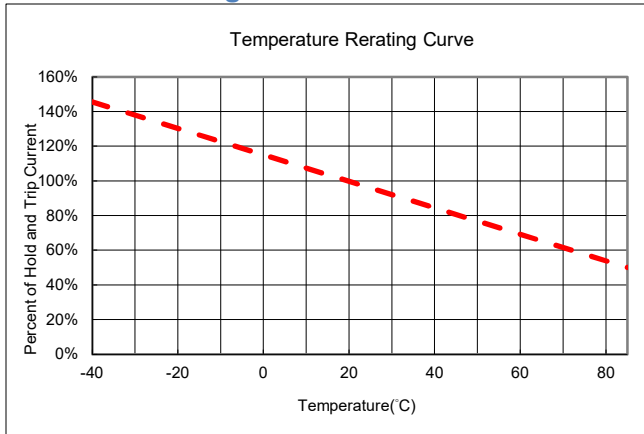

Cautionary Notes

- Each product should be carefully evaluated and tested for their suitability of application.
- Avoid PTC devices from being exposed to prolonged high temperature and/or high humidity storage environment such as 85°C and/or 85RH% which could diminish PTC's performance.
- Operation beyond the specified maximum ratings or improper use may result in damage and possible electrical arcing and/or flames.
- These Polymer PTC (PPTC) devices are intended for protection against occasional overcurrent/overtemperature fault conditions and may not be suitable for use in applications where repeated and/or prolonged fault conditions are anticipated.
- Avoid contact of PTC device with chemical solvent. Prolonged contact may adversely impact PTC performance.
- These PTC devices may not be suitable for use in circuits with a large inductance, as the PTC trip can generate circuit voltage spikes above the PTC rated voltage.
- These devices may be used in both DC and AC circuits provided that peak-to-peak line voltage when carrying AC does not exceed PTC's Vmax rating. As PTCs are essentially thermal devices, the RMS value of AC current carried by a PTC will produce tripping parameters and times-to-trip similar to those of a DC voltage of the same magnitude.
- If potting is mandated, avoid rigid potting compounds as they will encase the PTC and prevent it from volumetrically expanding to properly respond to a trip event.
- MSL: 2a (According to IPC J-Std-020).

Warning:

Low Rho PPTC tends to increase its Electrical Resistance over time, so shelf life is shorter, usually about 2 years in sealed vacuum bag and stored at temperature-controlled warehouse.

Recommend that once vacuum bag opened, Low Rho PPTC has had to be mounted on PCB immediately.

Disclaimer Notice - Information furnished is believed to be accurate and reliable. However, users should independently evaluate the suitability of and test each product selected for their own applications. Bel products are not designed for and may not be used in all applications.



Specifications subject to change without notice

Bel Fuse Inc.
300 Executive Drive, Suite 300,
West Orange, NJ 07052 USA

+1 201.432.0463
Bel.US.CS@belf.com
belfuse.com/circuit-protection

Environmental Specifications

Temperature cycling	JESD22 Method JA-104
Biased humidity	MIL-STD-202 Method 103
Operational life	MIL-STD-202 Method 108
Resistance to solvents	MIL-STD-202 Method 215
Mechanical shock	MIL-STD-202 Method 213
Vibration	MIL-STD-202 Method 204
Resistance to soldering heat	MIL-STD-202 Method 210
Thermal shock	MIL-STD-202 Method 107
Solderability	ANSI/J-STD-002

Solder Reflow and Rework Recommendations

Profile Feature	Pb-Free Assembly
Average Ramp-Up Rate (T _{smax} to T _p)	3°C/second max
Preheat :	
Temperature Min (T _{smin})	150°C
Temperature Max (T _{smax})	200°C
Time (t _{smin} to t _{smax})	60-180 seconds
Time maintained above:	
Temperature(T _L)	217°C
Time (t _L)	60-150 seconds
Peak/Classification Temperature(T _p) :	260°C
Time within 5°C of actual Peak :	
Temperature (t _p)	20-40 seconds
Ramp-Down Rate :	6°C/second max.
Time 25°C to Peak Temperature :	8 minutes max

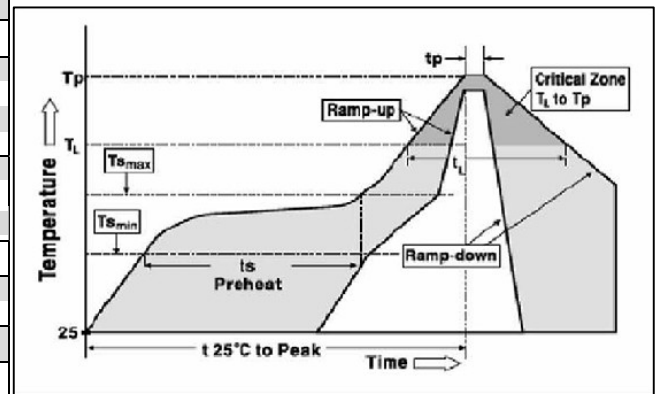

Solder Reflow

Due to "lead free / RoHS compliant" construction of these PTC devices, the required Temperature and Dwell Time in the "Soldering" zone of the reflow profile are greater than those used for non-RoHS devices.

1. Recommended reflow methods; IR, vapor phase oven, hot air oven.
2. Not Recommended for Wave Solder / Direct Immersion.
3. Recommended paste thickness range – 0.20 – 0.25mm.
4. Devices are compatible with standard industry cleaning solvents and methods.
5. MSL: 2a (According to IPC J-Std-020).

Caution

If reflow temperature / dwell times exceed the recommended profile, the electrical performance of the PTC may be affected.

Devices are not designed to be wave soldered to the bottom side of the board.

Rework: MIL-STD-202G Method 210F, Test Condition A.

Standard Packaging

Part Number	Tape/Reel Qty
0ZLM0025FF2G	4000
0ZLM0035FF2G	4000
0ZLM0050FF2G	4000
0ZLM0075FF2G	4000

4000 fuses in 7 inches dia. Reel, 8mm wide tape, 4mm pitch, per EIA-481 (equivalent IEC-286 part 3).

P/N Explanation and Ordering Information

	0ZLM 0XXX XX XX
FUSE TYPE	0ZLM,0603 SIZE
I HOLD Rating	Refer to Part Number and IH Rating in Electrical Characteristics Table on P.1.
Electrical Characteristics	F=standard Design A to Z (except FF)=special, customer spec, DCR sort, etc
Mechanical Feature	F=standard Design A to Z (except FF)=special, customer spec, lead forming, etc.
Tape & Reel Qty	See standard packaging



Specifications subject to change without notice

Bel Fuse Inc.
300 Executive Drive, Suite 300,
West Orange, NJ 07052 USA

+1 201.432.0463
Bel.US.CS@belf.com
belfuse.com/circuit-protection