

Description

The AHE101 is an InSb (Ultra-High Sensitivity) Hall element with an output voltage of 415mV (max.).

The AHE101 is a device that operates even in weak magnetic fields due to its ultra-high sensitivity.

Classification Hall Voltage V_H

Rank	V_H (mV)	Conditions
C	168 to 204	B = 50mT, $V_c = 1V$
D	196 to 236	
E	228 to 274	
F	266 to 320	
G	310 to 370	
H	360 to 415	

Features

- Ultra-High Sensitivity
- Classic SOT23-4 (Type A) Package
- **Totally Lead-Free & Fully RoHS Compliant (Notes 1 & 2)**
- **Halogen and Antimony Free. "Green" Device (Note 3)**
- **For automotive applications requiring specific change control (i.e. parts qualified to AEC-Q100/101/104/200, PPAP capable, and manufactured in IATF 16949 certified facilities), please [contact us](mailto:contact@diodes.com) or your local Diodes representative. <https://www.diodes.com/quality/product-definitions/>**

- Notes:
1. No purposely added lead. Fully EU Directive 2002/95/EC (RoHS), 2011/65/EU (RoHS 2) & 2015/863/EU (RoHS 3) compliant.
 2. See <https://www.diodes.com/quality/lead-free/> for more information about Diodes Incorporated's definitions of Halogen- and Antimony-free, "Green" and Lead-free.
 3. Halogen- and Antimony-free "Green" products are defined as those which contain <900ppm bromine, <900ppm chlorine (<1500ppm total Br + Cl) and <1000ppm antimony compounds.

Pin Assignments

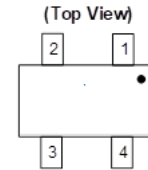

Input	1(±)	3(∓)
Output	2(±)	4(∓)

SOT23-4 (Type A)

Applications

- Detection of opening and closing of mobile phones and PCs
- Detection with Joysticks
- Magnetic encoders
- Current measurements with overhead wire ammeters (clamp type ammeters)
- Position detection with brushless motors, wheel rotation speed detection
- Contactless commutations, speed measurements, and angular position sensing/indexing in consumer home appliances, office equipment, and industrial applications

Absolute Maximum Ratings

Symbol	Characteristic	Value	Unit
I _{C_MAX}	Maximum Input Current	20	mA
V _{C_MAX}	Maximum Input Voltage	2	V
T _{OP}	Operating Temperature Range	-40 to +125	°C
T _S	Storage Temperature Range	-55 to +150	°C

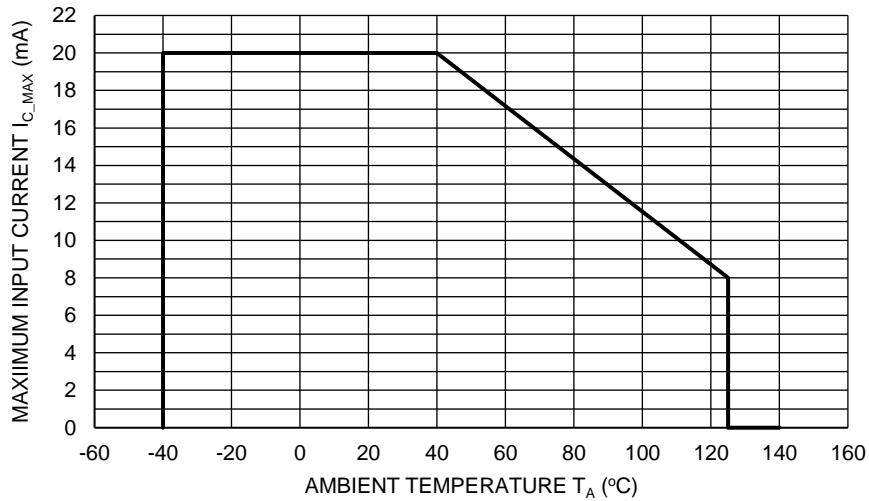

Figure 1. Maximum Input Current I_{C_MAX} vs Temperature

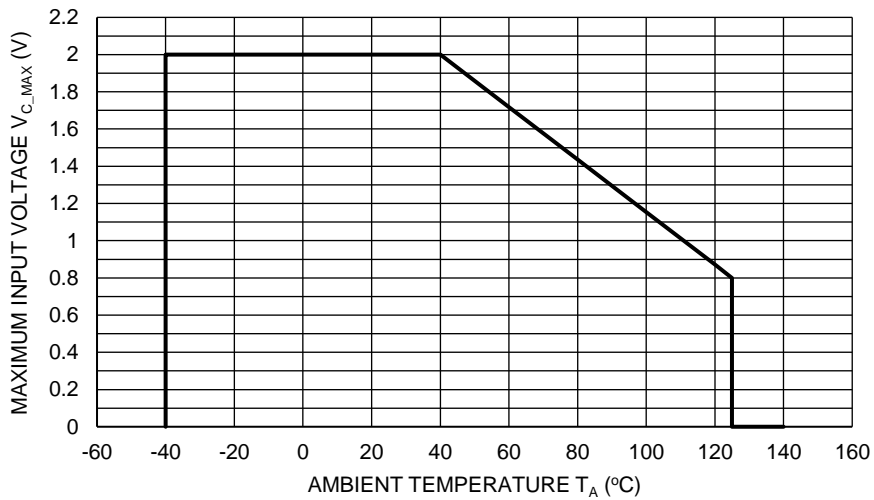

Figure 2. Maximum Input Voltage V_{C_MAX} vs Temperature

Electrical Characteristics (@T_A = +25°C, unless otherwise specified.)

Characteristic	Symbol	Test Condition	Min	Typ	Max	Unit
Hall Voltage	V _H (Note 4)	B = 50mT, V _C = 1V T _A = +25°C	168	—	415	mV
Input Resistance	R _{IN}	B = 0mT, I _C = 0.1mA T _A = +25°C	240	—	550	Ω
Output Resistance	R _{OUT}	B = 0mT, I _C = 0.1mA T _A = +25°C	240	—	550	Ω
Offset Voltage	V _{OS}	B = 0mT, V _C = 1V T _A = +25°C	-5	—	+5	mV
Temp. Coeffi. of V _H	α V _H (Note 5)	B = 50mT, I _C = 5mA, T _A = 0°C to +40°C	—	-1.8	—	%/°C
Temp. Coeffi. of R _{IN}	α R _{IN} (Note 6)	B = 0mT, I _C = 0.1mA, T _A = 0°C to +40°C	—	-1.8	—	%/°C

Table 1. Electrical Characteristics

Notes:

4. $V_H = V_{H-M} - V_{OS}$
In which V_{H-M} is the output Hall voltage, V_H is the Hall voltage and V_{OS} is the offset voltage under the identical electrical stimuli.
5. $\alpha V_H = \frac{1}{V_H(T_1)} \times \frac{V_H(T_3) - V_H(T_2)}{(T_3 - T_2)} \times 100$
6. $\alpha R_{IN} = \frac{1}{R_{IN}(T_1)} \times \frac{R_{IN}(T_3) - R_{IN}(T_2)}{(T_3 - T_2)} \times 100$
T₁ = +20°C, T₂ = 0°C, T₃ = +40°C

Typical Operating Characteristics

Input Resistance R_{IN} as A Function of Temperature T_A

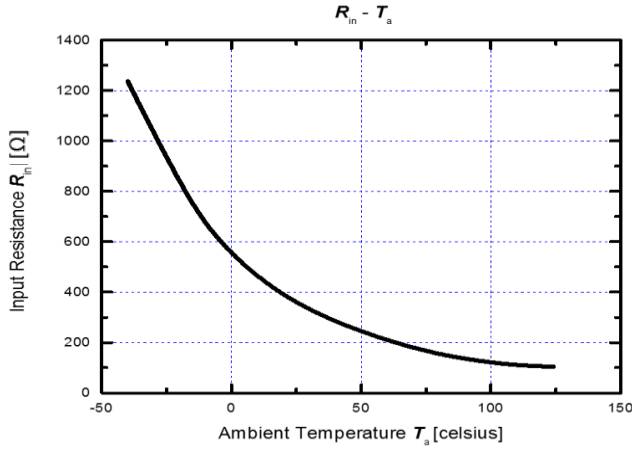

Hall Voltage V_H as A Function of Magnetic Flux Density B

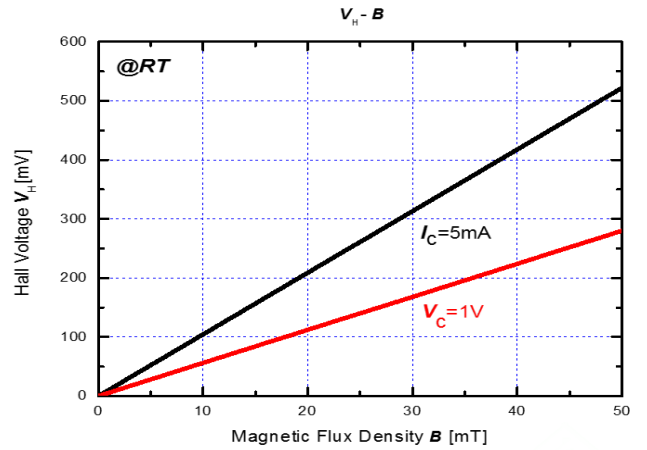

Hall Voltage V_H as A Function of Ambient Temperature T_A

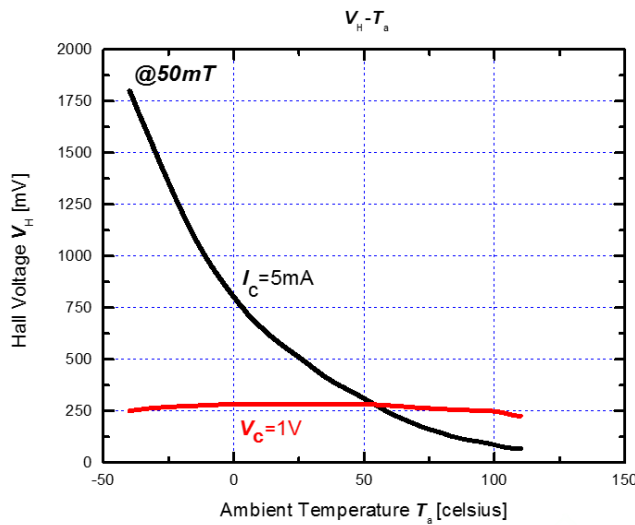

Hall Voltage V_H as A Function of Electrical Stimuli I_C/V_C

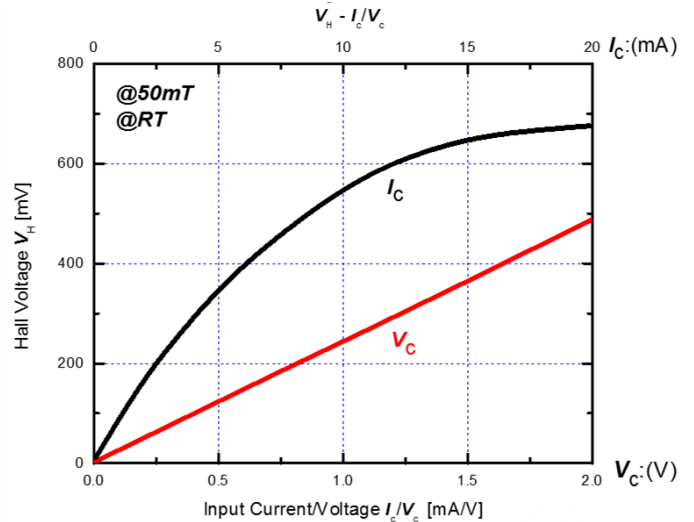

Offset Voltage V_{OS} as A Function of Electrical Stimuli I_C/V_C

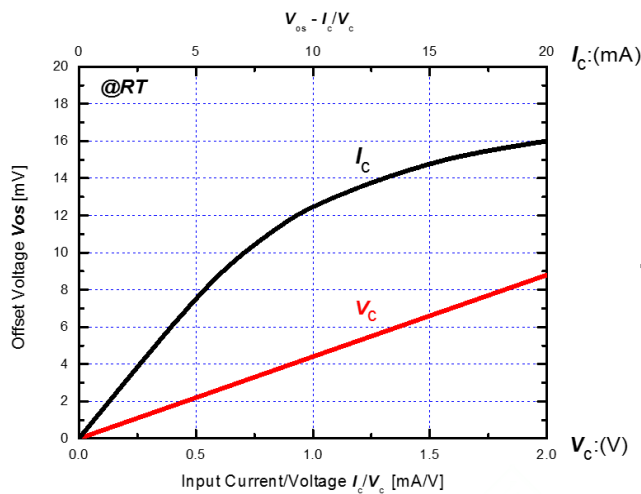

Ordering Information (Note 7)

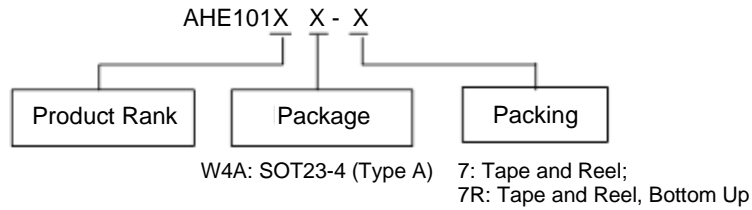

Orderable Part Number	Package Code	Package	Part Number Suffix	Packing	
				Qty.	Carrier
AHE101C-W4A-7	W4A	SOT23-4 (Type A)	-7	3,000	7" Tape & Reel
AHE101D-W4A-7	W4A	SOT23-4 (Type A)	-7	3,000	7" Tape & Reel
AHE101E-W4A-7	W4A	SOT23-4 (Type A)	-7	3,000	7" Tape & Reel
AHE101F-W4A-7	W4A	SOT23-4 (Type A)	-7	3,000	7" Tape & Reel
AHE101G-W4A-7	W4A	SOT23-4 (Type A)	-7	3,000	7" Tape & Reel
AHE101H-W4A-7	W4A	SOT23-4 (Type A)	-7	3,000	7" Tape & Reel
AHE101C-W4A-7R	W4A	SOT23-4 (Type A)	-7R	3,000	7" Tape & Reel
AHE101D-W4A-7R	W4A	SOT23-4 (Type A)	-7R	3,000	7" Tape & Reel
AHE101E-W4A-7R	W4A	SOT23-4 (Type A)	-7R	3,000	7" Tape & Reel
AHE101F-W4A-7R	W4A	SOT23-4 (Type A)	-7R	3,000	7" Tape & Reel
AHE101G-W4A-7R	W4A	SOT23-4 (Type A)	-7R	3,000	7" Tape & Reel
AHE101H-W4A-7R	W4A	SOT23-4 (Type A)	-7R	3,000	7" Tape & Reel

7. For packaging details, go to our website at <https://www.diodes.com/design/support/packaging/diodes-packaging/>.

Marking Information

Package Type: SOT23-4 (Type A)

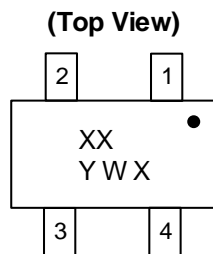

XX: Identification Code
 Y: Year 0 to 9
 W: Week: A to Z: Week 1 to 26;
 a to z: Week 27 to 52; z Represents
 52 and 53 Week
 X: Internal Code

Orderable Part Number	Package	Identification Code
AHE101C-W4A-7	SOT23-4 (Type A)	AC
AHE101D-W4A-7	SOT23-4 (Type A)	AD
AHE101E-W4A-7	SOT23-4 (Type A)	AE
AHE101F-W4A-7	SOT23-4 (Type A)	AF
AHE101G-W4A-7	SOT23-4 (Type A)	AG
AHE101H-W4A-7	SOT23-4 (Type A)	AH
AHE101C-W4A-7R	SOT23-4 (Type A)	AC
AHE101D-W4A-7R	SOT23-4 (Type A)	AD
AHE101E-W4A-7R	SOT23-4 (Type A)	AE
AHE101F-W4A-7R	SOT23-4 (Type A)	AF
AHE101G-W4A-7R	SOT23-4 (Type A)	AG
AHE101H-W4A-7R	SOT23-4 (Type A)	AH

Package Outline Dimensions

Please see <http://www.diodes.com/package-outlines.html> for the latest version.

SOT23-4 (Type A)

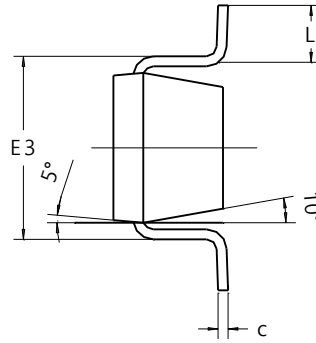
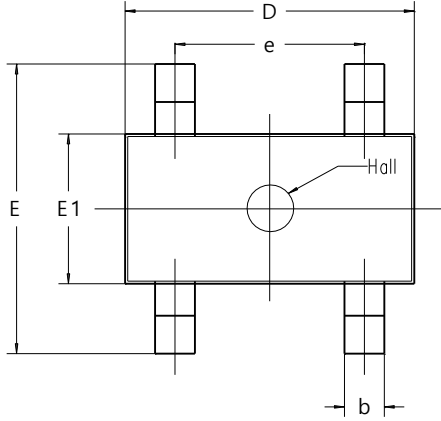

SOT23-4 (Type A)			
Dim	Min	Max	Typ
A2	1.00	1.20	1.10
A3	0.75	0.85	0.80
b	0.35	0.45	0.40
c	0.10	0.105	--
D	2.80	3.00	2.90
E	2.70	3.10	2.90
E1	1.35	1.55	1.45
E3	1.73	1.93	1.83
e	1.80	2.00	1.90
L	0.47	0.67	0.57
All Dimensions in mm			

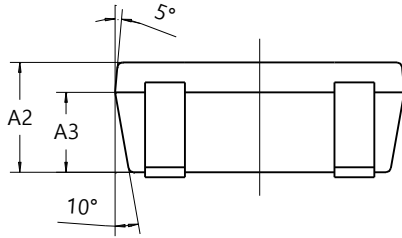

Sensor Location

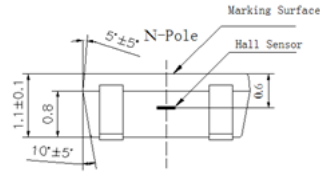
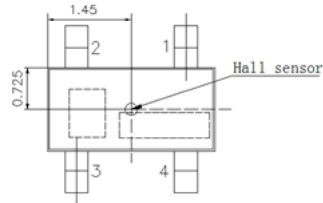

Suggested Pad Layout

Please see <http://www.diodes.com/package-outlines.html> for the latest version.

SOT23-4 (Type A)

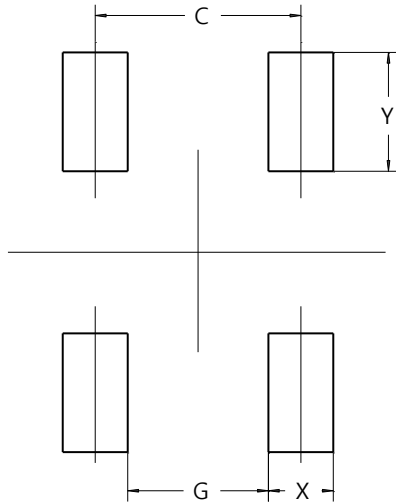

Dimensions	Value (in mm)
C	1.900
G	1.300
X	0.600
Y	1.400

Reliability Test Terms

Criteria:

Terms	Conditions	Duration
High-Temperature Storage	(JEITA EIAJ ED-4701) $T_A = +150$ (0 to +10) $^{\circ}\text{C}$	1000hrs
Heat Cycle	(JEITA EIAJ ED-4701) $T_A = -55^{\circ}\text{C}$ to $+150^{\circ}\text{C}$ High Temp. - Normal Temp. - Low Temp. 30min - 5min - 30min	30 cycles
Temperature Humidity Storage	(JEITA EIAJ ED-4701) $T_A = +85^{\circ}\text{C} \pm 3^{\circ}\text{C}$, $R_H = 85 \pm 5\%$	1000hrs
Reflow Soldering	(JEITA EIAJ ED-4701) $T_A = +260^{\circ}\text{C} \pm 5^{\circ}\text{C}$	10sec
High-Temperature Operating	$T_A = +125^{\circ}\text{C}$, $V_C = 1\text{V}$	1000hrs

- Variation of Hall voltage V_H and input/output resistances $R_{IN/OUT}$ are less than 20%.
- Variation of offset voltage V_{OS} is less than $\pm 16\text{mV}$.
- Other parameters in Table 1 are still within their ranges stated in Table 1.

Mechanical Data

- Moisture Sensitivity: Level 3 per J-STD-020
- Terminals: Finish – Matte Tin Plated Leads, Solderable per MIL-STD-202, Method 208 ③
- Weight: 0.00126 grams (Approximate)

Tape Orientation

- For AHE101x-W4A-7

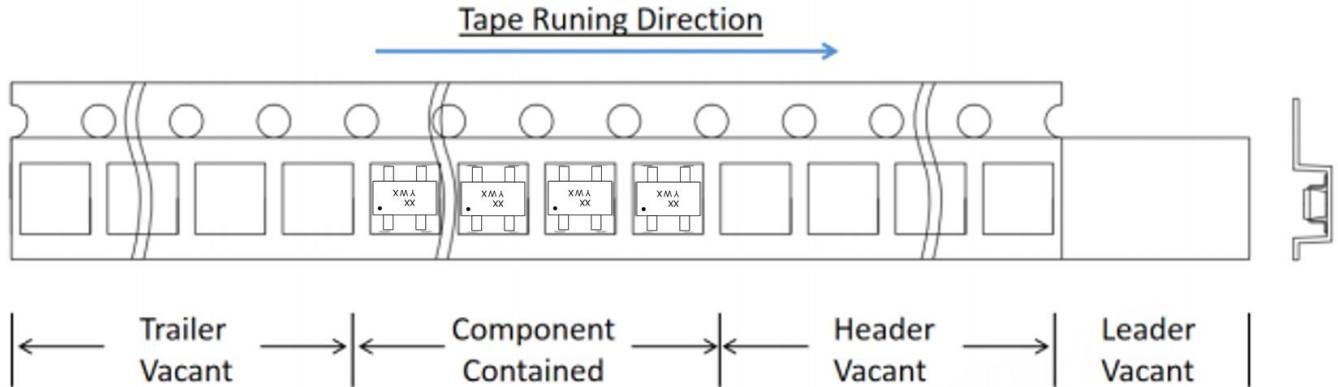

- For AHE101x-W4A-7R: Bottom Side Up

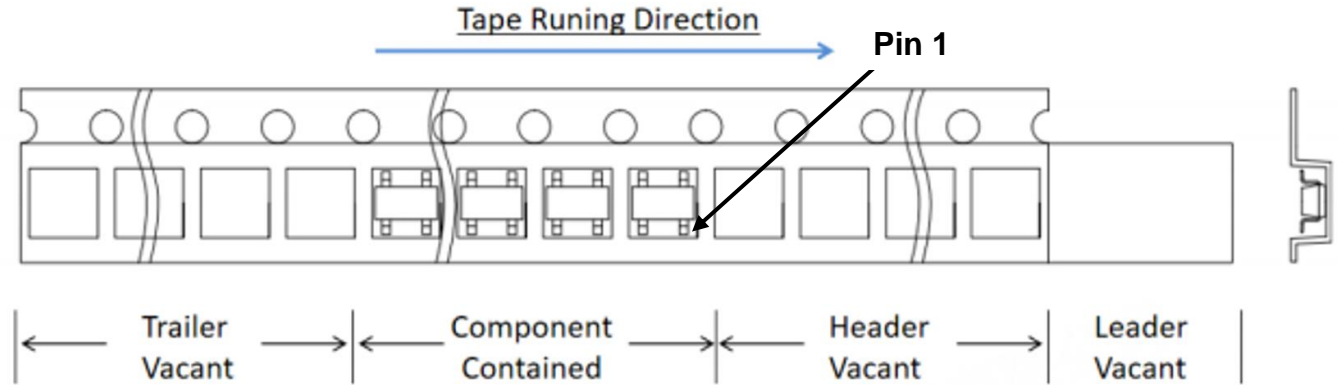

IMPORTANT NOTICE

1. DIODES INCORPORATED (Diodes) AND ITS SUBSIDIARIES MAKE NO WARRANTY OF ANY KIND, EXPRESS OR IMPLIED, WITH REGARDS TO ANY INFORMATION CONTAINED IN THIS DOCUMENT, INCLUDING, BUT NOT LIMITED TO, THE IMPLIED WARRANTIES OF MERCHANTABILITY, FITNESS FOR A PARTICULAR PURPOSE OR NON-INFRINGEMENT OF THIRD PARTY INTELLECTUAL PROPERTY RIGHTS (AND THEIR EQUIVALENTS UNDER THE LAWS OF ANY JURISDICTION).
2. The Information contained herein is for informational purpose only and is provided only to illustrate the operation of Diodes' products described herein and application examples. Diodes does not assume any liability arising out of the application or use of this document or any product described herein. This document is intended for skilled and technically trained engineering customers and users who design with Diodes' products. Diodes' products may be used to facilitate safety-related applications; however, in all instances customers and users are responsible for (a) selecting the appropriate Diodes products for their applications, (b) evaluating the suitability of Diodes' products for their intended applications, (c) ensuring their applications, which incorporate Diodes' products, comply the applicable legal and regulatory requirements as well as safety and functional-safety related standards, and (d) ensuring they design with appropriate safeguards (including testing, validation, quality control techniques, redundancy, malfunction prevention, and appropriate treatment for aging degradation) to minimize the risks associated with their applications.
3. Diodes assumes no liability for any application-related information, support, assistance or feedback that may be provided by Diodes from time to time. Any customer or user of this document or products described herein will assume all risks and liabilities associated with such use, and will hold Diodes and all companies whose products are represented herein or on Diodes' websites, harmless against all damages and liabilities.
4. Products described herein may be covered by one or more United States, international or foreign patents and pending patent applications. Product names and markings noted herein may also be covered by one or more United States, international or foreign trademarks and trademark applications. Diodes does not convey any license under any of its intellectual property rights or the rights of any third parties (including third parties whose products and services may be described in this document or on Diodes' website) under this document.
5. Diodes' products are provided subject to Diodes' Standard Terms and Conditions of Sale (<https://www.diodes.com/about/company/terms-and-conditions/terms-and-conditions-of-sales/>) or other applicable terms. This document does not alter or expand the applicable warranties provided by Diodes. Diodes does not warrant or accept any liability whatsoever in respect of any products purchased through unauthorized sales channel.
6. Diodes' products and technology may not be used for or incorporated into any products or systems whose manufacture, use or sale is prohibited under any applicable laws and regulations. Should customers or users use Diodes' products in contravention of any applicable laws or regulations, or for any unintended or unauthorized application, customers and users will (a) be solely responsible for any damages, losses or penalties arising in connection therewith or as a result thereof, and (b) indemnify and hold Diodes and its representatives and agents harmless against any and all claims, damages, expenses, and attorney fees arising out of, directly or indirectly, any claim relating to any noncompliance with the applicable laws and regulations, as well as any unintended or unauthorized application.
7. While efforts have been made to ensure the information contained in this document is accurate, complete and current, it may contain technical inaccuracies, omissions and typographical errors. Diodes does not warrant that information contained in this document is error-free and Diodes is under no obligation to update or otherwise correct this information. Notwithstanding the foregoing, Diodes reserves the right to make modifications, enhancements, improvements, corrections or other changes without further notice to this document and any product described herein. This document is written in English but may be translated into multiple languages for reference. Only the English version of this document is the final and determinative format released by Diodes.
8. Any unauthorized copying, modification, distribution, transmission, display or other use of this document (or any portion hereof) is prohibited. Diodes assumes no responsibility for any losses incurred by the customers or users or any third parties arising from any such unauthorized use.
9. This Notice may be periodically updated with the most recent version available at <https://www.diodes.com/about/company/terms-and-conditions/important-notice>

The Diodes logo is a registered trademark of Diodes Incorporated in the United States and other countries.
All other trademarks are the property of their respective owners.
© 2025 Diodes Incorporated. All Rights Reserved.

www.diodes.com