

# PolarHV™ Power MOSFET

N-Channel Enhancement Mode  
Fast Recovery Diode  
Avalanche Rated

**IXFH26N60P**  
**IXFT26N60P**  
**IXFV26N60P**  
**IXFV26N60PS**

$V_{DSS} = 600 \text{ V}$   
 $I_{D25} = 26 \text{ A}$   
 $R_{DS(on)} \leq 270 \text{ m}\Omega$   
 $t_{rr} \leq 200 \text{ ns}$

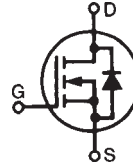

Symbol	Test Conditions	Maximum Ratings	
$V_{DSS}$	$T_J = 25^\circ\text{C}$ to $150^\circ\text{C}$	600	V
$V_{DGR}$	$T_J = 25^\circ\text{C}$ to $150^\circ\text{C}$ ; $R_{GS} = 1 \text{ M}\Omega$	600	V
$V_{GSS}$	Continuous	$\pm 30$	V
$V_{GSM}$	Transient	$\pm 40$	V
$I_{D25}$	$T_C = 25^\circ\text{C}$	26	A
$I_{DM}$	$T_C = 25^\circ\text{C}$ , pulse width limited by $T_{JM}$	65	A
$I_{AR}$	$T_C = 25^\circ\text{C}$	13	A
$E_{AR}$	$T_C = 25^\circ\text{C}$	40	mJ
$E_{AS}$	$T_C = 25^\circ\text{C}$	1.2	J
$dv/dt$	$I_S \leq I_{DM}$ , $di/dt \leq 100 \text{ A}/\mu\text{s}$ , $V_{DD} \leq V_{DSS}$ $T_J \leq 150^\circ\text{C}$ , $R_G = 5 \Omega$	10	V/ns
$P_D$	$T_C = 25^\circ\text{C}$	460	W
$T_J$		-55 ... +150	$^\circ\text{C}$
$T_{JM}$		150	$^\circ\text{C}$
$T_{stg}$		-55 ... +150	$^\circ\text{C}$
$T_L$	1.6 mm (0.062 in.) from case for 10 s	300	$^\circ\text{C}$
$T_{SOLD}$	Plastic body for 10 s	260	$^\circ\text{C}$
$M_d$	Mounting torque (TO-3P&TO-247)	1.13/10	Nm/lb.in.
$F_c$	Mounting force (PLUS220)	11..65/2.5..15	N/lb
Weight	TO-247	6.0	g
	TO-268	5.0	g
	PLUS220 & PLUS220SMD	4.0	g

TO-247 (IXFH)

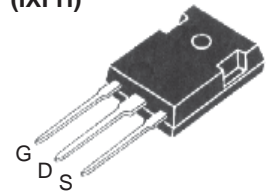

TO-268 (IXFT)

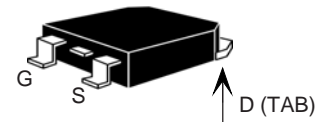

PLUS220 (IXFV)

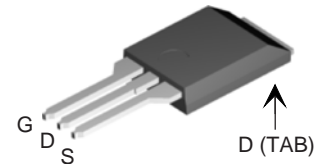

PLUS220SMD (IXFV...S)

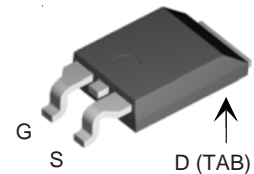

G = Gate      D = Drain  
S = Source      TAB = Drain

Symbol	Test Conditions ( $T_J = 25^\circ\text{C}$ , unless otherwise specified)	Characteristic Values		
		Min.	Typ.	Max.
$BV_{DSS}$	$V_{GS} = 0 \text{ V}$ , $I_D = 250 \mu\text{A}$	600		V
$V_{GS(th)}$	$V_{DS} = V_{GS}$ , $I_D = 4 \text{ mA}$	2.5		V
$I_{GSS}$	$V_{GS} = \pm 30 \text{ V}$ , $V_{DS} = 0 \text{ V}$			$\pm 100 \text{ nA}$
$I_{DSS}$	$V_{DS} = V_{DSS}$ $V_{GS} = 0 \text{ V}$ $T_J = 125^\circ\text{C}$			25 $\mu\text{A}$
				250 $\mu\text{A}$
$R_{DS(on)}$	$V_{GS} = 10 \text{ V}$ , $I_D = 0.5 I_{D25}$ Pulse test, $t \leq 300 \mu\text{s}$ , duty cycle $d \leq 2 \%$			270 $\text{m}\Omega$

### Features

- Fast Recovery diode
- Unclamped Inductive Switching (UIS) rated
- International standard packages
- Low package inductance
- easy to drive and to protect

### Advantages

- Easy to mount
- Space savings
- High power density

Symbol	Test Conditions	Characteristic Values		
		(T <sub>J</sub> = 25°C, unless otherwise specified)		
		Min.	Typ.	Max.
<b>g<sub>fs</sub></b>	V <sub>DS</sub> = 20 V; I <sub>D</sub> = 0.5 I <sub>D25</sub> , pulse test	16	26	S
<b>C<sub>iss</sub></b>	V <sub>GS</sub> = 0 V, V <sub>DS</sub> = 25 V, f = 1 MHz		4150	pF
<b>C<sub>oss</sub></b>			400	pF
<b>C<sub>rss</sub></b>			27	pF
<b>t<sub>d(on)</sub></b>	V <sub>GS</sub> = 10 V, V <sub>DS</sub> = 0.5 I <sub>D25</sub> R <sub>G</sub> = 5 Ω (External)		25	ns
<b>t<sub>r</sub></b>			27	ns
<b>t<sub>d(off)</sub></b>			75	ns
<b>t<sub>f</sub></b>			21	ns
<b>Q<sub>g(on)</sub></b>	V <sub>GS</sub> = 10 V, V <sub>DS</sub> = 0.5 V <sub>DSS</sub> , I <sub>D</sub> = 0.5 I <sub>D25</sub>		72	nC
<b>Q<sub>gs</sub></b>			27	nC
<b>Q<sub>gd</sub></b>			24	nC
<b>R<sub>thJC</sub></b>				0.27 °C/W
<b>R<sub>thCs</sub></b>	(PLUS220 & TO-247)		0.21	°C/W

Symbol	Test Conditions	Characteristic Values		
		(T <sub>J</sub> = 25°C, unless otherwise specified)		
		Min.	Typ.	Max.
<b>I<sub>S</sub></b>	V <sub>GS</sub> = 0 V			26 A
<b>I<sub>SM</sub></b>	Repetitive			78 A
<b>V<sub>SD</sub></b>	I <sub>F</sub> = I <sub>S</sub> , V <sub>GS</sub> = 0 V, pulse test			1.5 V
<b>t<sub>rr</sub></b>	I <sub>F</sub> = 25A, -di/dt = 100 A/μs V <sub>R</sub> = 100V; V <sub>GS</sub> = 0 V		150	200 ns
<b>I<sub>RM</sub></b>				7
<b>Q<sub>RM</sub></b>			0.7	μC

### Characteristic Curves

**Fig. 1. Output Characteristics**  
@ 25°C

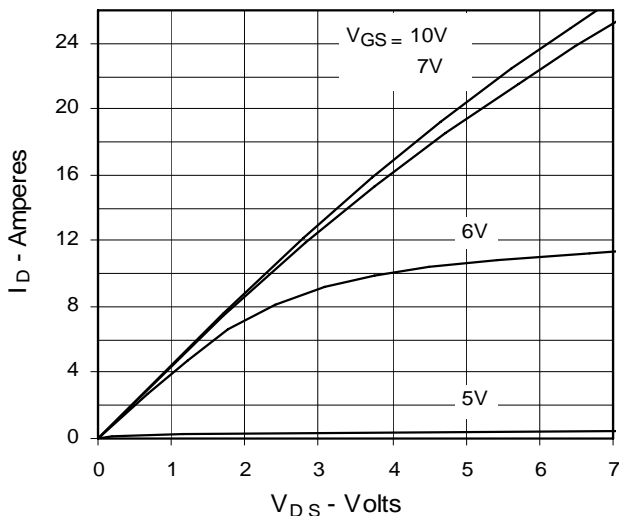

**Fig. 2. Extended Output Characteristics**  
@ 25°C

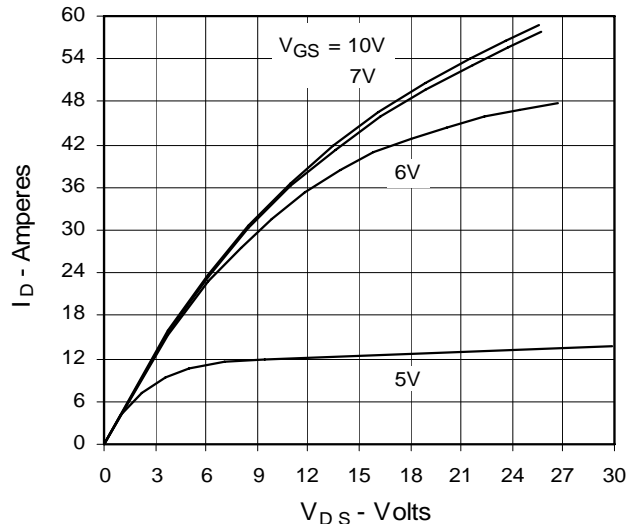

IXYS reserves the right to change limits, test conditions, and dimensions.

IXYS MOSFETs and IGBTs are covered by 4,835,592 4,931,844 5,049,961 5,237,481 6,162,665 6,404,065 B1 6,683,344 6,727,585  
 one or more of the following U.S. patents: 4,850,072 5,017,508 5,063,307 5,381,025 6,259,123 B1 6,534,343 6,710,405 B2 6,759,692  
 4,881,106 5,034,796 5,187,117 5,486,715 6,306,728 B1 6,583,505 6,710,463 6,771,478 B2

**Fig. 3. Output Characteristics @ 125°C**

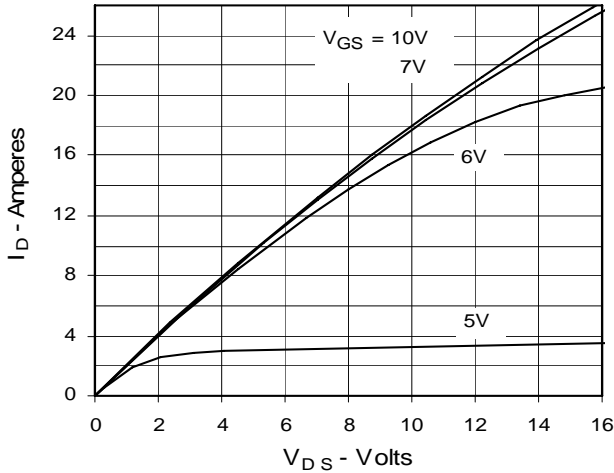

**Fig. 4.  $R_{DS(on)}$  Normalized to 0.5  $I_{D25}$  Value vs. Junction Temperature**

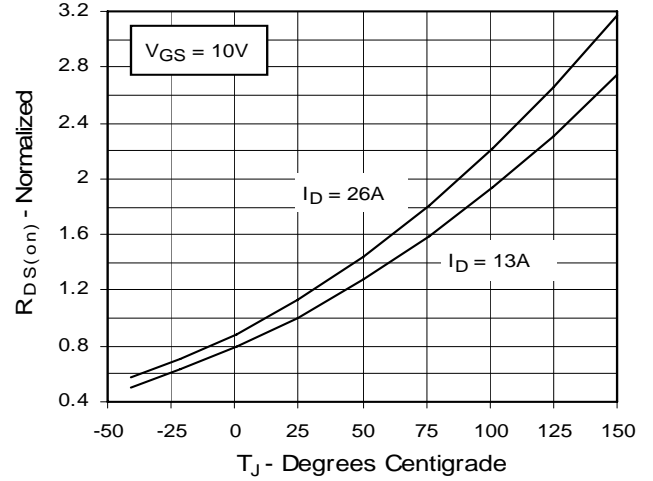

**Fig. 5.  $R_{DS(on)}$  Normalized to 0.5  $I_{D25}$  Value vs.  $I_D$**

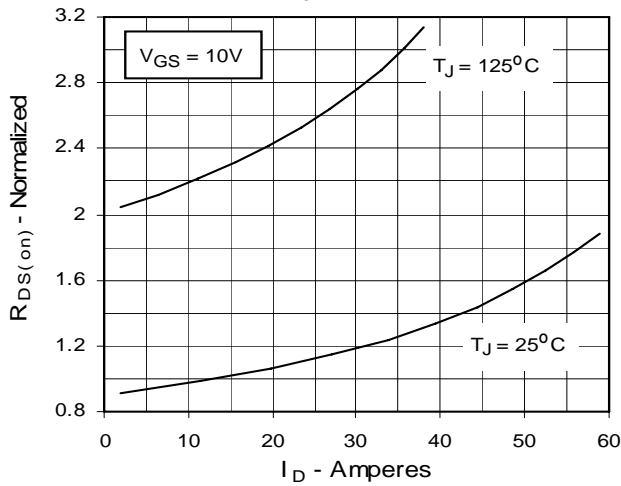

**Fig. 6. Drain Current vs. Case Temperature**

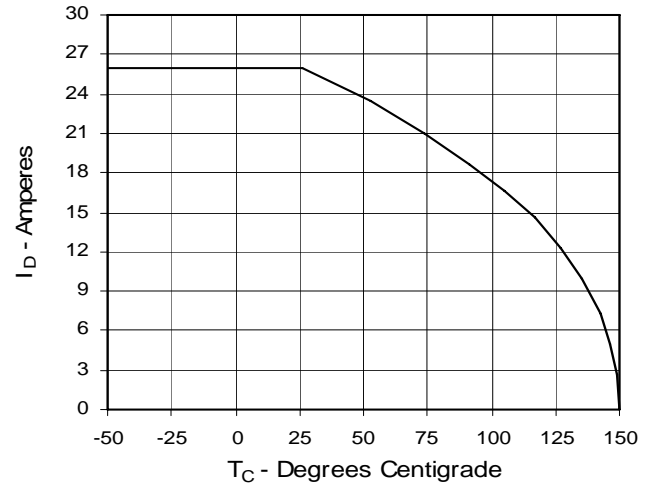

**Fig. 7. Input Admittance**

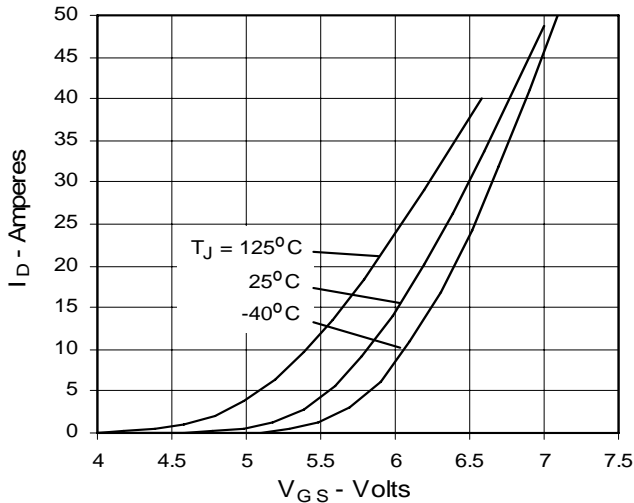

**Fig. 8. Transconductance**

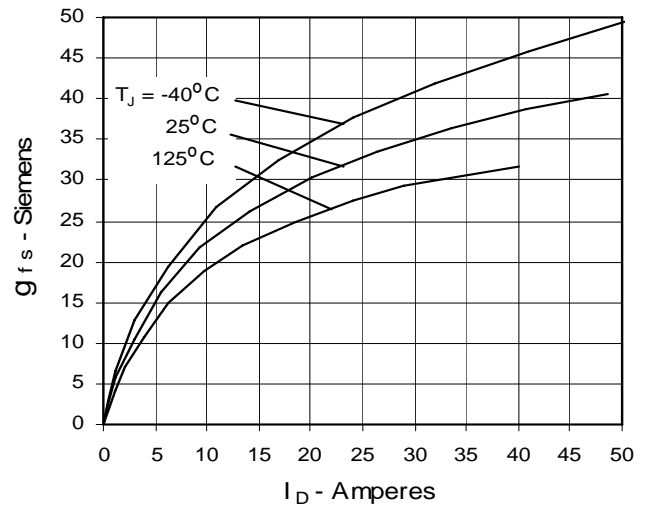

**Fig. 9. Source Current vs. Source-To-Drain Voltage**

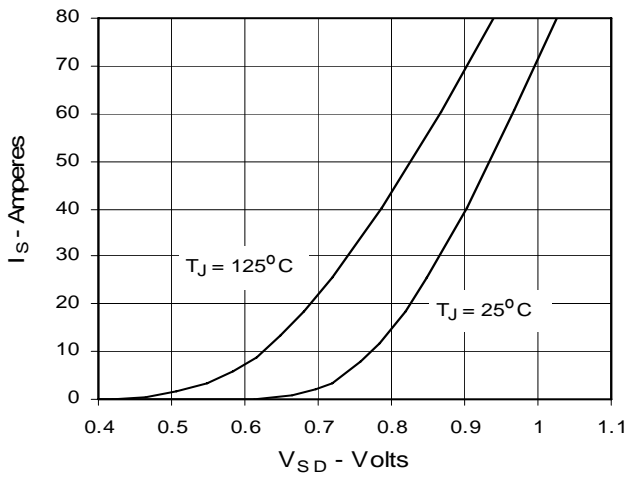

**Fig. 10. Gate Charge**

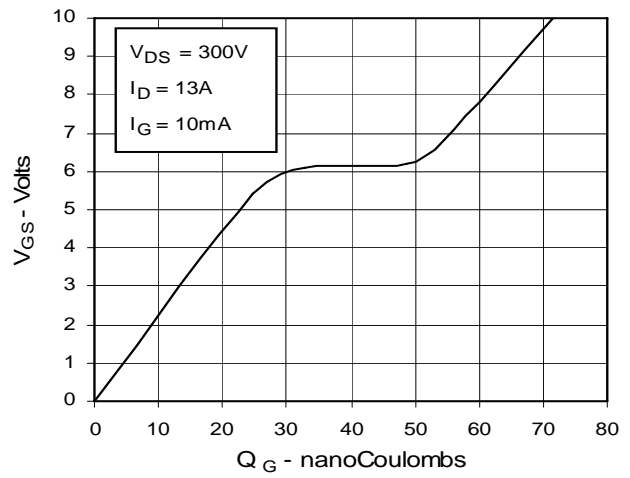

**Fig. 11. Capacitance**

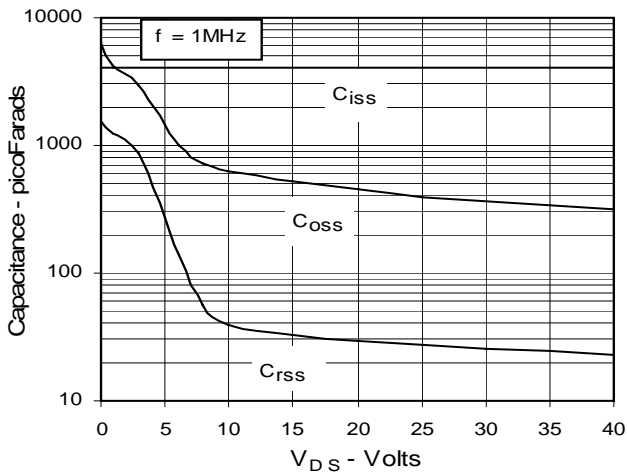

**Fig. 12. Maximum Transient Thermal Resistance**

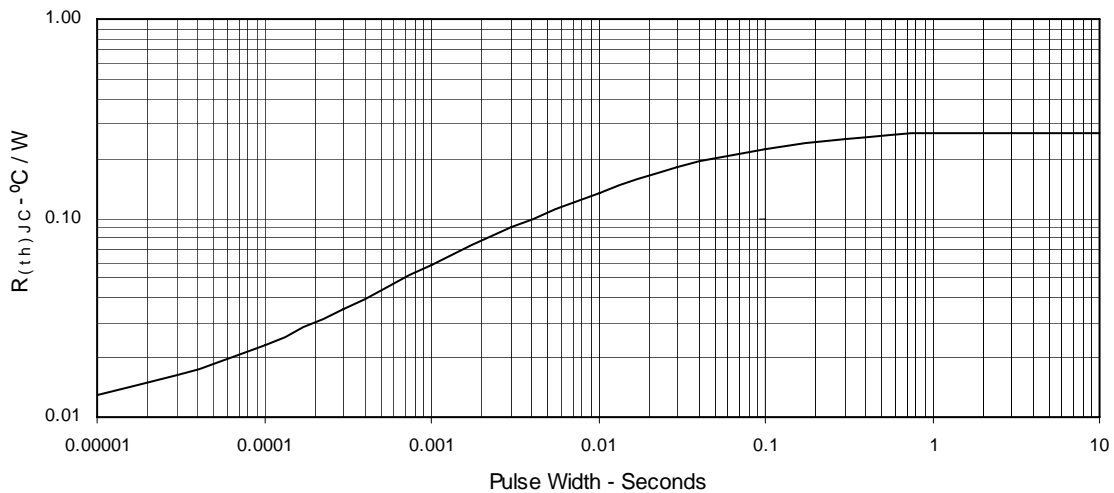

**TO-247 AD (IXFH) Outline**

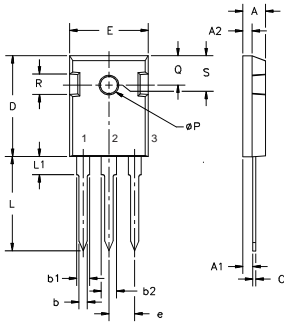

Dim.	Millimeter		Inches	
	Min.	Max.	Min.	Max.
A	4.7	5.3	.185	.209
A <sub>1</sub>	2.2	2.54	.087	.102
A <sub>2</sub>	2.2	2.6	.059	.098
b	1.0	1.4	.040	.055
b <sub>1</sub>	1.65	2.13	.065	.084
b <sub>2</sub>	2.87	3.12	.113	.123
C	.4	.8	.016	.031
D	20.80	21.46	.819	.845
E	15.75	16.26	.610	.640
e	5.20	5.72	0.205	0.225
L	19.81	20.32	.780	.800
L1		4.50		.177
∅P	3.55	3.65	.140	.144
Q	5.89	6.40	0.232	0.252
R	4.32	5.49	.170	.216
S	6.15 BSC		242 BSC	

**TO-268 (IXFT) Outline**

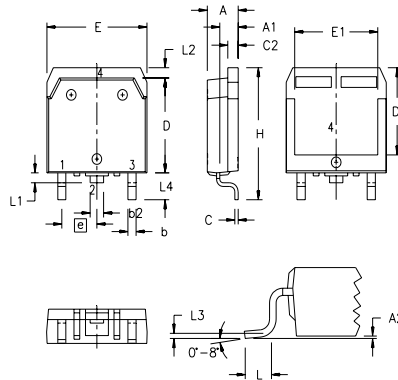

SYM	INCHES		MILLIMETERS	
	MIN	MAX	MIN	MAX
A	.193	.201	4.90	5.10
A <sub>1</sub>	.106	.114	2.70	2.90
A <sub>2</sub>	.001	.010	0.02	0.25
b	.045	.057	1.15	1.45
b <sub>2</sub>	.075	.083	1.90	2.10
C	.016	.026	0.40	0.65
C <sub>2</sub>	.057	.063	1.45	1.60
D	.543	.551	13.80	14.00
D <sub>1</sub>	.488	.500	12.40	12.70
E	.624	.632	15.85	16.05
E <sub>1</sub>	.524	.535	13.30	13.60
e	.215 BSC		5.45 BSC	
H	.736	.752	18.70	19.10
L	.094	.106	2.40	2.70
L <sub>1</sub>	.047	.055	1.20	1.40
L <sub>2</sub>	.039	.045	1.00	1.15
L <sub>3</sub>	.010 BSC		0.25 BSC	
L <sub>4</sub>	.150	.161	3.80	4.10

**PLUS220 (IXFV) Outline**

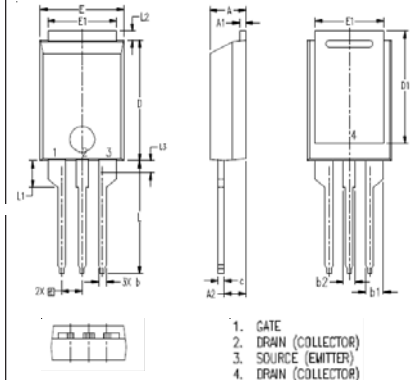

SYM	INCHES		MILLIMETER	
	MIN	MAX	MIN	MAX
A	.169	.185	4.30	4.70
A <sub>1</sub>	.028	.035	0.70	0.90
A <sub>2</sub>	.098	.118	2.50	3.00
b	.035	.047	0.90	1.20
b <sub>1</sub>	.080	.095	2.03	2.41
b <sub>2</sub>	.054	.064	1.37	1.63
c	.028	.035	0.70	0.90
D	.551	.591	14.00	15.00
D <sub>1</sub>	.512	.539	13.00	13.70
E	.394	.433	10.00	11.00
E <sub>1</sub>	.331	.346	8.40	8.80
e	.100 BSC		2.54 BSC	
L	.512	.551	13.00	14.00
L <sub>1</sub>	.118	.138	3.00	3.50
L <sub>2</sub>	.035	.051	0.90	1.30
L <sub>3</sub>	.047	.059	1.20	1.50

1. GATE
2. DRAIN (COLLECTOR)
3. SOURCE (EMITTER)
4. DRAIN (COLLECTOR)

**PLUS220SMD (IXFV\_S) Outline**

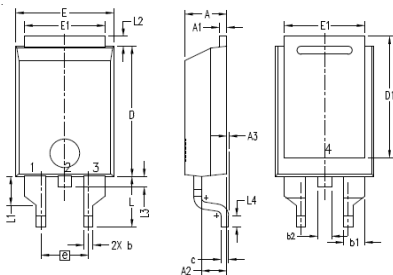

SYM	INCHES		MILLIMETER	
	MIN	MAX	MIN	MAX
A	.169	.185	4.30	4.70
A <sub>1</sub>	.028	.035	0.70	0.90
A <sub>2</sub>	.098	.118	2.50	3.00
A <sub>3</sub>	.000	.010	0.00	0.25
b	.035	.047	0.90	1.20
b <sub>1</sub>	.080	.095	2.03	2.41
b <sub>2</sub>	.054	.064	1.37	1.63
c	.028	.035	0.70	0.90
D	.551	.591	14.00	15.00
D <sub>1</sub>	.512	.539	13.00	13.70
E	.394	.433	10.00	11.00
E <sub>1</sub>	.331	.346	8.40	8.80
e	.200 BSC		5.08 BSC	
L	.209	.228	5.30	5.80
L <sub>1</sub>	.118	.138	3.00	3.50
L <sub>2</sub>	.035	.051	0.90	1.30
L <sub>3</sub>	.047	.059	1.20	1.50
L <sub>4</sub>	.039	.059	1.00	1.50

1. GATE
2. DRAIN (COLLECTOR)
3. SOURCE (EMITTER)
4. DRAIN (COLLECTOR)



---

Disclaimer Notice - Information furnished is believed to be accurate and reliable. However, users should independently evaluate the suitability of and test each product selected for their own applications. Littelfuse products are not designed for, and may not be used in, all applications. Read complete Disclaimer Notice at [www.littelfuse.com/disclaimer-electronics](http://www.littelfuse.com/disclaimer-electronics).