

Description

- 3.2 x 1.5mm SMD crystal in a ceramic package with a seam sealed metal lid, hermetically sealed.
- Model CFPX-217
- Model Issue number 7

Frequency Parameters

- Frequency 32.7680kHz
- Frequency Tolerance ± 10.00 ppm
- Tolerance Condition @25°C
- Overtone Order Fundamental
- Ageing ± 3 ppm max first year @25°C
 ± 3 °C

Electrical Parameters

- Load Capacitance (CL) 7.00pF
- Shunt Capacitance (C0) 1.0pF typical
- Drive Level 1.0µW max
- ESR 70.00kΩ max

Environmental Parameters

- Storage Temperature Range: -55 to 125°C
- Drop: 100g dummy, 150cm drop (3 directions x 10 times) onto concrete.
- Vibration: 1.5mm amplitude, 10Hz~60Hz with cycle time of 2~3 minutes in 3 directions (X, Y and Z axis) each for 2 hours.

Manufacturing Details

- RoHS Terminations NiAu
- RoHS Reflow Temp 260°C max for 10 seconds

Compliance

- RoHS Status (2015/863/EU) Compliant
- REACH Status Compliant
- MSL Rating (JDEC-STD-033): Not Applicable

Packaging Details

- Tape & reel in accordance with EIA-481
Quantities below the standard reel size to be supplied on cut tape

Standard Pack Quantity: 3,000

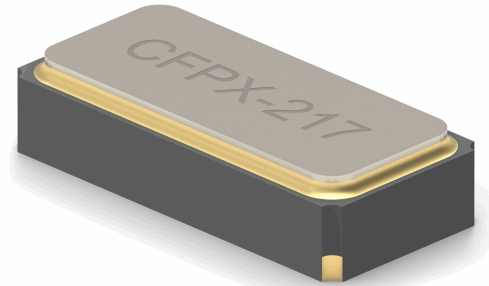

Outline (mm)

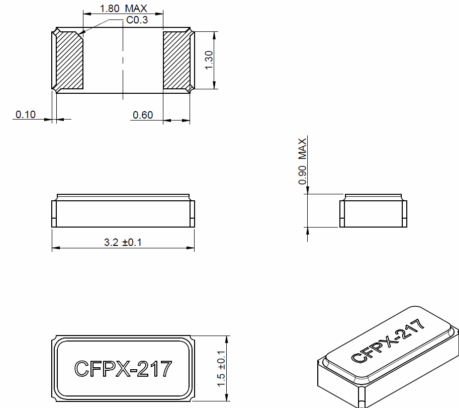

Recommended Solder Pad Layout

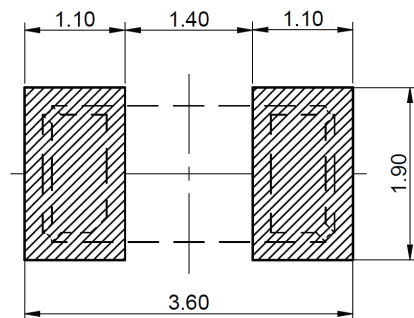

Sales Office Contact Details:

UK: +44 (0)1460 270200

Email: info@iqdfrequencyproducts.com

Web: www.iqdfrequencyproducts.com

Typical Frequency Stability Characteristics

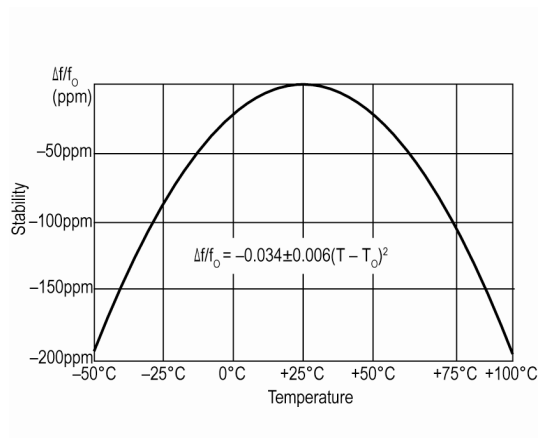

Sales Office Contact Details:

UK: +44 (0)1460 270200

Email: info@iqdfrequencyproducts.com

Web: www.iqdfrequencyproducts.com