

Customer Part:

Description

- Industry standard leaded package
Resistance welded, hermetically sealed in an inert atmosphere, glass to metal seals on leads
- Standard 2 leg HC49 package
- Model HC49
- Model Issue number 16

Frequency Parameters

- Frequency 9.83040MHz
- Frequency Tolerance $\pm 30.00\text{ppm}$
- Frequency Stability $\pm 50.00\text{ppm}$
- Operating Temperature Range -20.00 to 70.00°C
- Overtone Order Fundamental
- Ageing $\pm 5\text{ppm}$ max per year

Electrical Parameters

- Load Capacitance 18.00pF
- Shunt Capacitance 7pF max
- Drive Level 1mW max
- ESR 50.00 Ω max

Environmental Parameters

- Shock: MIL-STD-202 Method 213, Condition C, Half sine shock pulse peak acceleration of 100g, pulse duration 6ms.
- Vibration: MIL-STD-202 Method 204, 5g for 20 minutes, 12 cycles in each of the 3 orientations, 10~2000Hz.
- Storage Temperature Range: -55 to 125°C

Manufacturing Details

- RoHS Terminations Sn, Ag & Cu
- RoHS Reflow Temp 260°C max over 10 seconds

Compliance

- RoHS Status (2015/863/EU) Compliant
- REACH Status Compliant
- MSL Rating (JDEC-STD-033): Not Applicable

Packaging Details

- Bulk pack

Standard Pack Quantity: 100



Outline (mm)

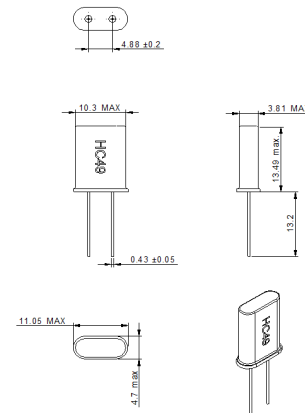

Sales Office Contact Details:

UK: +44 (0)1460 270200

Email: info@iqdfrequencyproducts.com

Web: www.iqdfrequencyproducts.com