

CV28D-FCC Lensed RGB LEDs with FusionBeam™ Technology



PRODUCT DESCRIPTION

CV28D LEDs are an industry-first solution that delivers the best of both P2 and SMD signage LEDs with excellent directionality, image quality and resolution in a waterproof, UV-stabilized SMD package designed to last in any environment. CV28D LEDs enable a new generation of high-resolution information signs that can display icons, photos, logos and video instead of just text.

FusionBeam™ Technology expands Cree LED's lineup of patented improvements for signage LEDs, including waterproof packages, high contrast packages and tilted viewing angles. FusionBeam Technology fuses colors together to improve image quality and directs the beam of light to the intended audience to reduce light pollution in all directions. LEDs with FusionBeam bring the advantages of SMD LEDs over P2 LEDs to a broader range of installation applications.

FEATURES

- Size (mm): 2.8 x 2.8 x 4.5
- Typical pitch range: 6 mm - 10 mm+
- NIT level: see [page 3](#)
- Beam angle: 30° typical
- Dominant wavelength
 - Red (619 - 624 nm)
 - Green (520 - 540 nm)
 - Blue (460 - 480 nm)
- Typical luminous intensity (mcd)
 - Red: 1000 mcd
 - Green: 2000 mcd
 - Blue: 280 mcd
- Water resistant (IPX6/IPX8)*
- Moisture sensitivity level: 5a
- Lead free
- RoHS compliant

APPLICATIONS

Full-color, high resolution signs and displays in both indoor and outdoor locations, including:

- Roadway
- Retail
- Scoreboards
- Pools
- Breezeways
- Lobbies
- Atriums
- Interior facades

- CV28D LEDs are tested for water resistance mounted on PCBs, with a silicone layer protecting the electrical leads from moisture. Customers are required to protect the electrical leads from moisture to achieve the IPx8 rating.

Cree LED / 4001 E. Hwy. 54, Suite 2000 / Durham, NC 27713 USA / +1.919.313.5330 / www.cree-led.com

TABLE OF CONTENTS

Typical Nit Level	3
Absolute Maximum Ratings	4
Typical Electrical & Optical Characteristics	4
Intensity Bin Limit	5
Color Bin Limit	5
Order Code Table	6
Graphs	7
Mechanical Dimensions	10
Kit Number System	11
Reflow Soldering	12
Notes	13
Packaging	14

TYPICAL NIT LEVEL

Typical Nit level in context of pitch and scan rate

Screen Pitch	Scan Rates	
	1/4	1/2
P6	33,850	67,700
P8	19,050	38,100
P10	12,200	24,400
P12	8,450	16,950
P15	5,400	10,850

Notes

- Estimated Nits
- 20 mA current

ABSOLUTE MAXIMUM RATINGS ($T_A = 25\text{ }^\circ\text{C}$)

Items	Symbol	Absolute Maximum Rating			Unit
		Red	Green	Blue	
Forward current ^{Note 1}	I_F	50	35	20	mA
Peak forward current ^{Note 2}	I_{FP}	200	100	100	mA
Reverse voltage	V_R	5	5	5	V
Power dissipation	P_D	130	119	76	mW
Operating temperature	T_{opr}	-40 ~ +85			$^\circ\text{C}$
Storage temperature	T_{stg}	-40 ~ +100			$^\circ\text{C}$
Junction temperature	T_J	110	110	110	$^\circ\text{C}$
Junction/ambient	R_{THJA}	440	480	420	$^\circ\text{C/W}$
Junction/solder point	R_{THJS}	180	230	200	$^\circ\text{C/W}$
Electrostatic discharge classification (MIL-STD-883E)	ESD	1000			V

Note:

1. Single-color light
2. Pulse width ≤ 0.1 msec, duty $\leq 1/10$.

TYPICAL ELECTRICAL & OPTICAL CHARACTERISTICS ($T_A = 25\text{ }^\circ\text{C}$)

Characteristics	Condition	Symbol	Values			Unit
			Red	Green	Blue	
Dominant wavelength	IF = 15 mA (R) IF = 10 mA (G) IF = 10 mA (B)	λ_{DOM}	619~624	520~540	460~480	nm
Spectral bandwidth at 50% I_{REL} max	IF = 15 mA (R) IF = 10 mA (G) IF = 10 mA (B)	$\Delta\lambda$	24	38	28	nm
Forward voltage	IF = 15 mA (R) IF = 10 mA (G) IF = 10 mA (B)	$V_{F(avg)}$	2.1	2.7	3.0	V
		$V_{F(max)}$	2.6	3.4	3.8	V
Luminous intensity	IF = 15 mA (R) IF = 10 mA (G) IF = 10 mA (B)	$I_{V(min)}$	710	1400	200	mcd
		$I_{V(avg)}$	1000	2000	280	mcd
Luminous Intensity (Reference)	IF = 20 mA (R/G/B)	$I_{V(avg)}$	1600	3900	500	mcd
Reverse current (max)	VR = 5 V	IR	10	10	10	μA

* Continuous reverse voltage can cause LED damage.

INTENSITY BIN LIMIT

Red (15 mA)			Green (10 mA)			Blue (10 mA)		
Bin Code	Min. (mcd)	Max. (mcd)	Bin Code	Min. (mcd)	Max. (mcd)	Bin Code	Min. (mcd)	Max. (mcd)
M	710	900	Q	1400	1800	bc	202	252
qr	805	1010	xy	1600	2020	F	224	280
N	900	1120	R	1800	2240	de	252	318
st	1010	1260	z1a	2020	2520	G	280	355
P	1120	1400	S	2240	2800	fg	318	403
vw	1260	1600	1b1c	2520	3175	H	355	450

* Tolerance of measurement of luminous intensity is $\pm 10\%$.

COLOR BIN LIMIT

Red (15 mA)			Green (10 mA)			Blue (10 mA)		
Bin Code	Min. (nm)	Max. (nm)	Bin Code	Min. (nm)	Max. (nm)	Bin Code	Min. (nm)	Max. (nm)
RB	619	624	G7	520	525	B3	460	465
			G23	522.5	527.5	B23	462.5	467.5
			G8	525	530	B4	465	470
			G45	527.5	532.5	B45	467.5	472.5
			G9	530	535	B5	470	475
			G67	532.5	537.5	B67	472.5	477.5
			Ga	535	540	B6	475	480

* Tolerance of measurement of dominant wavelength is ± 1 nm.

ORDER CODE TABLE

Kit Number	Color	Luminous Intensity (mcd)		Dominant Wavelength (nm)				Package
		Min.	Max.	Color Bin	Min.(nm)	Color Bin	Max.(nm)	
CV28D-FCC-CMvwQ1b1cbcHBB7a363	Red	710	1600	RB	619	RB	624	Reel
	Green	1400	3175	G7	520	Ga	540	Reel
	Blue	202	450	B3	460	B6	480	Reel
CV28D-FCC-CM1Q1bc1BB7D3D3	Red	Any 1 Intensity bin from M (710) - vw (1600)		RB	619	RB	624	Reel
	Green	Any 1 Intensity bin from Q (1400) - 1b1c (3175)		Any 1 hue bin from G7 (520) - Ga (540)				Reel
	Blue	Any 1 Intensity bin from bc (202) - H (450)		Any 1 hue bin from B3 (460) - B6 (480)				Reel

Notes

- The above kit numbers represent order codes that include multiple intensity-bin and color-bin codes. Only one intensity-bin code and one color-bin code will be shipped on each bulk. Single intensity-bin code and single color-bin codes will not be orderable.
- Please refer to be [HB LED Lamp Reliability Test Standards](#) document for reliability test conditions.
- Please refer to be [HB LED Lamp Soldering & Handling](#) document for information about how to use this LED product safely.

GRAPHS

The data below are collected from statistical figures that do not necessarily correspond to the actual parameters of each single LED. Hence, these data might be changed without further notice.

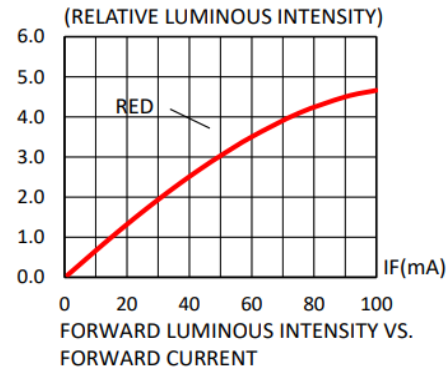
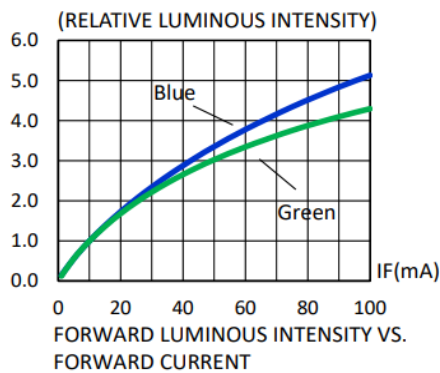
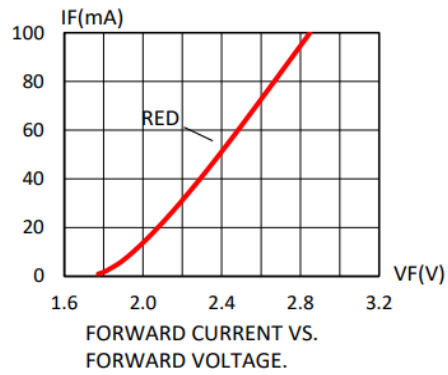
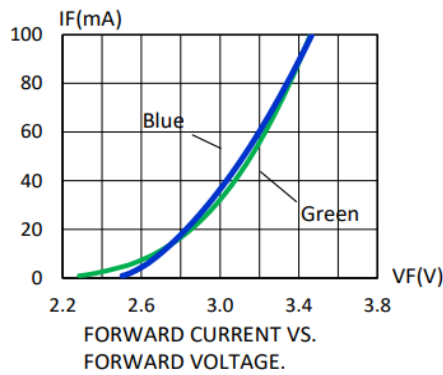
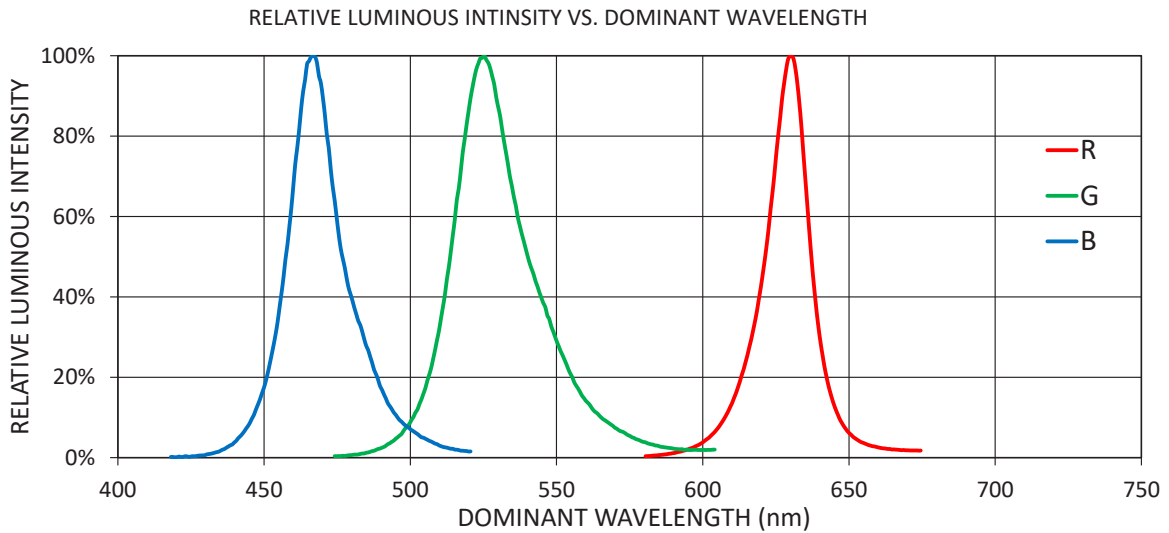

GRAPHS - CONTINUED

The data below are collected from statistical figures that do not necessarily correspond to the actual parameters of each single LED. Hence, these data might be changed without further notice.

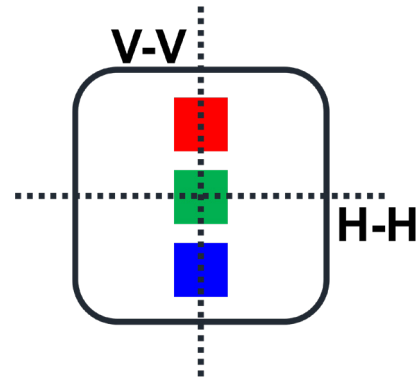
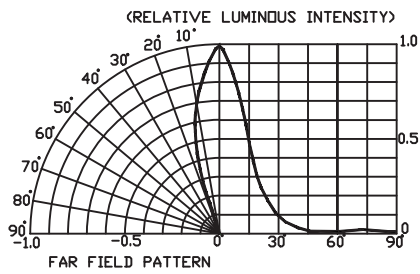
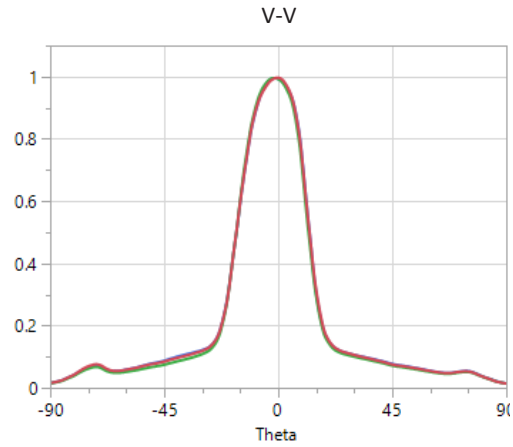
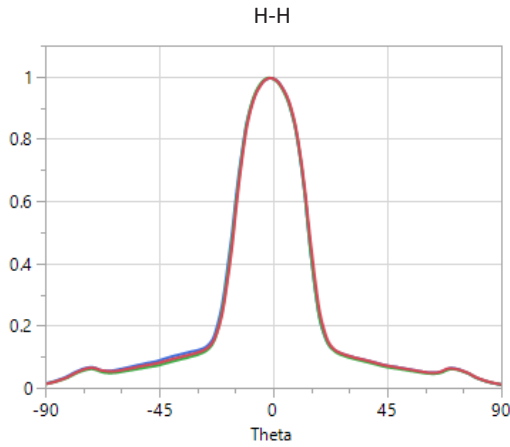

GRAPHS - CONTINUED

The data below are collected from statistical figures that do not necessarily correspond to the actual parameters of each single LED. Hence, these data might be changed without further notice.

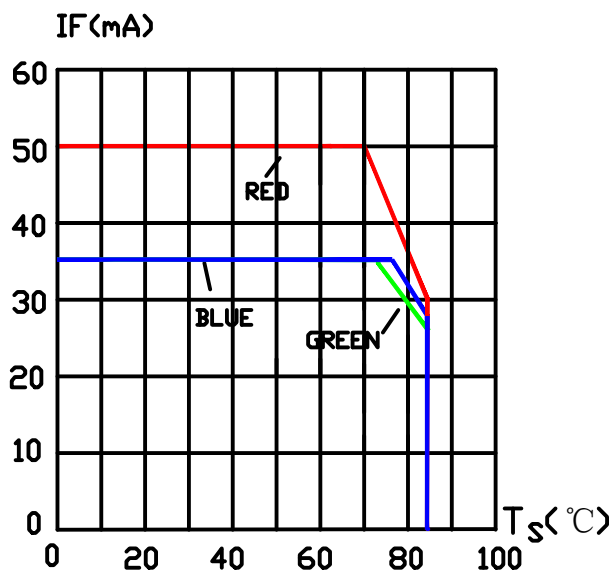

MAXIMUM FORWARD DC CURRENT VS, SOLDER POINT TEMPERATURE.

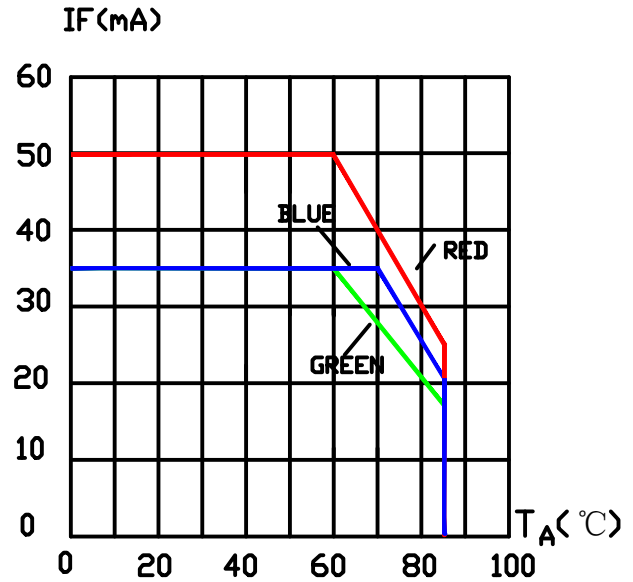

MAXIMUM FORWARD DC CURRENT VS, AMBIENT TEMPERATURE.

Color	PD	If_max	Vf_max	R _{ja}	R _{js}
Red	99	30	3.3	456	232
Green	120	30	4.0	450	230
Blue	120	30	4.0	450	230
White	120	30	4.0	580	262

PD = power dissipation = $I_{Fmax} * V_{Fmax}$

R_{ja} = thermal resistance from junction to ambient

R_{js} = thermal resistance from junction to solder point

MECHANICAL DIMENSIONS

All dimensions are in mm.
Measurement tolerance is ±0.1.

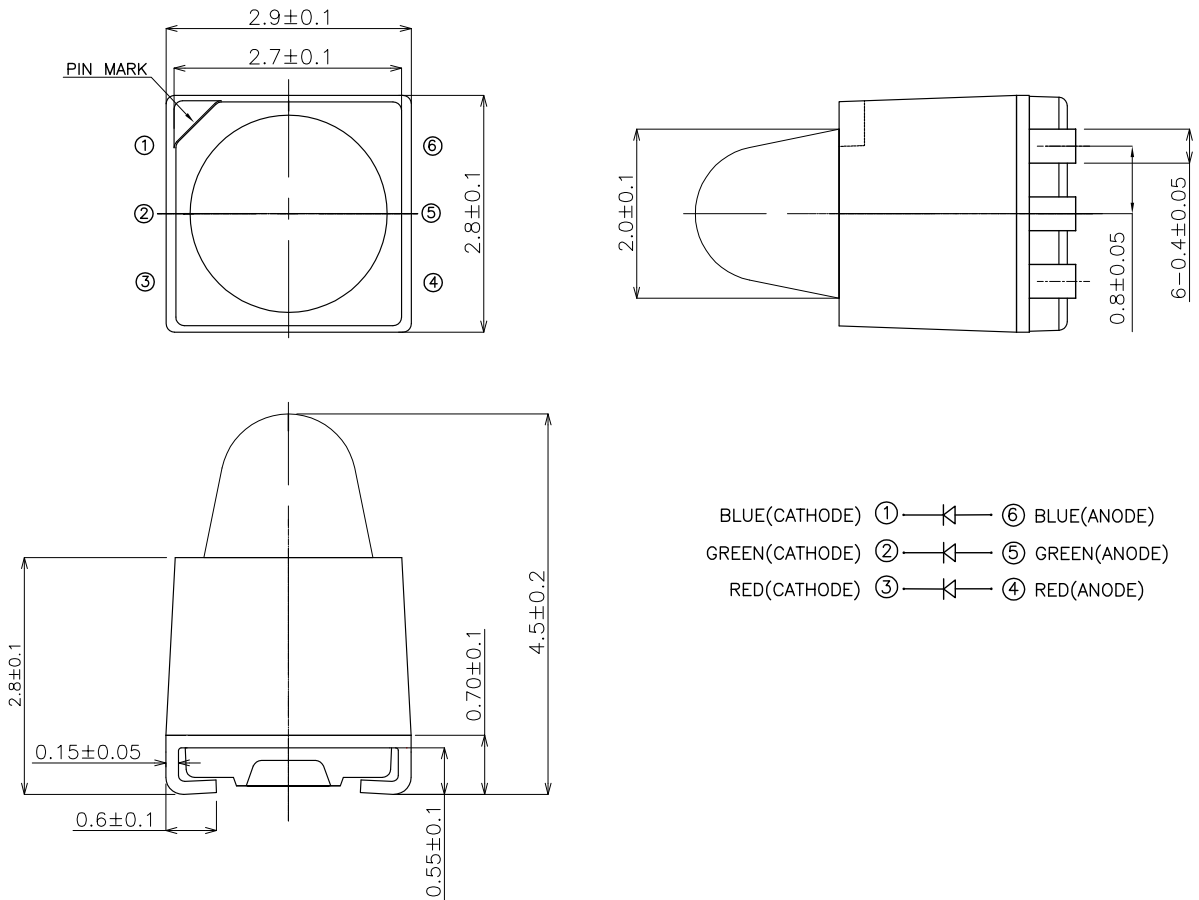

KIT NUMBER SYSTEM

CV28D LED lamps are tested and sorted into performance bins. A bin is specified by ranges of color, forward voltage, and brightness.

CV28D LEDs are sold by order codes in combinations of bins called kits. Order codes are configured in the following manner:

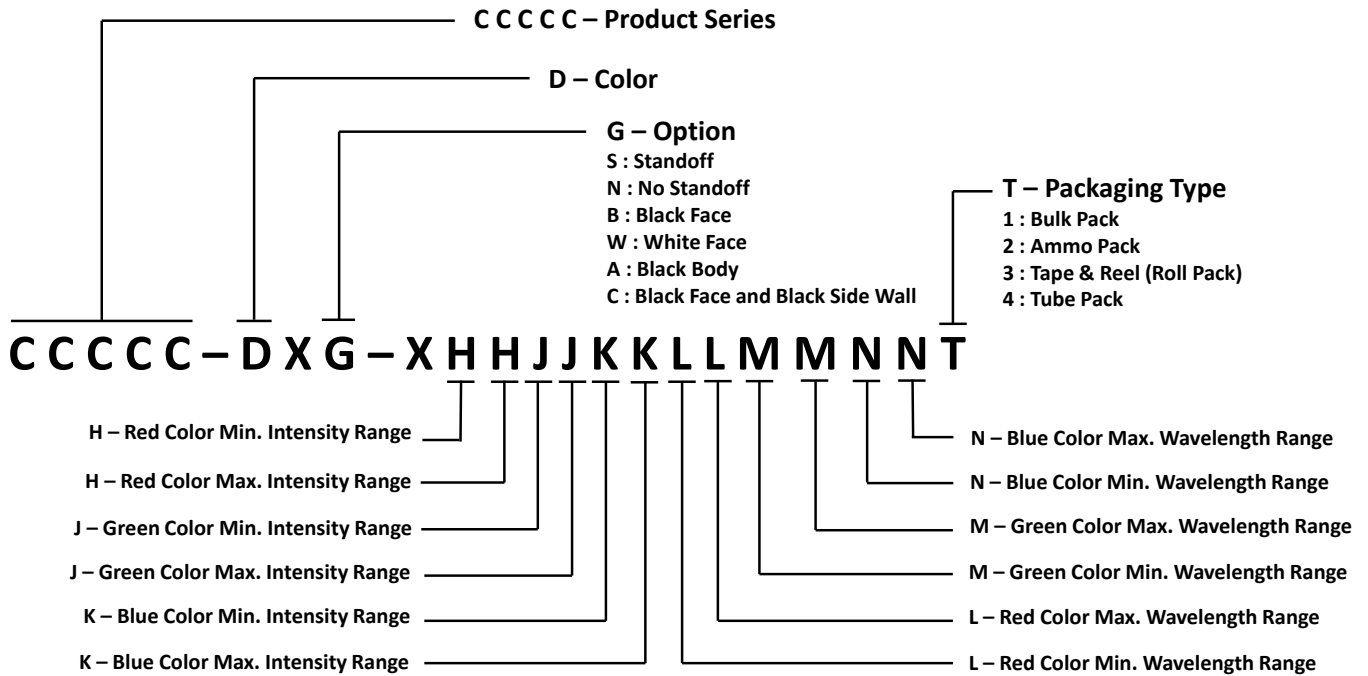

REFLOW SOLDERING

- The CV28D LED is rated as an MSL 5a product.
- The recommended floor life out of the bag is 24 hrs.
- The temperature profile is as below.

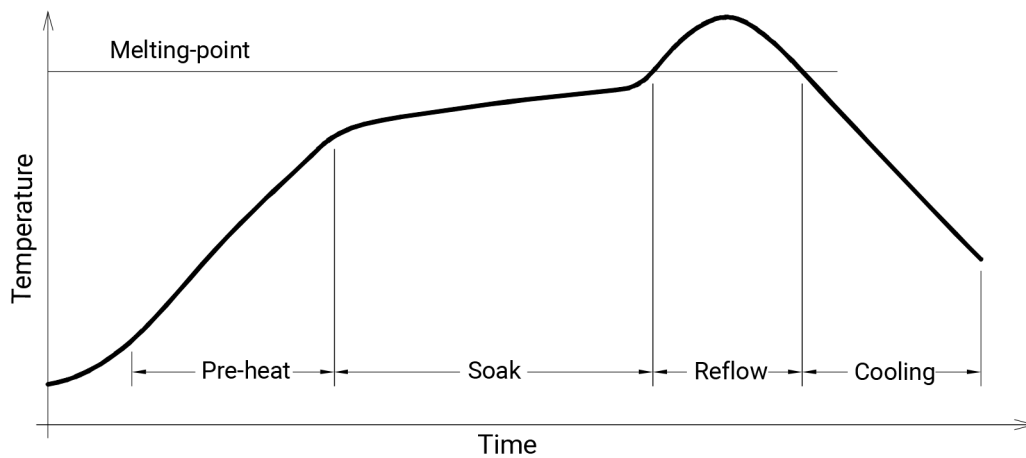

Use only with CV28

Solder Profile
Average ramp-up rate = 4 °C/second max.
Soak temperature = 150 °C-200 °C
Soak time = 120 seconds max.
Duration above 217 °C = 60 seconds max.
Peak temperature = 250 °C max.
Time within 5 °C of peak temperature = 10 seconds max.
Ramp-down rate = 6 °C/second max.

NOTES

The packaging sizes of these SMD products are very small and the resin is still soft after solidification. Users are required to handle them with care. Never touch the resin surface of SMD products.

To avoid damaging the product's surface and interior device, it is recommended to choose a special nozzle to pick up the SMD products during the process of SMT production. If handling is necessary, take special care when picking up these products. The following method is necessary:

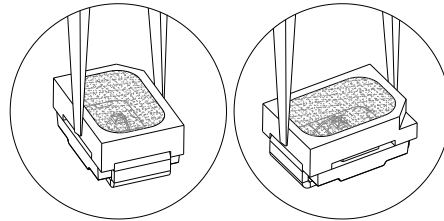

RoHS Compliance

The levels of RoHS restricted materials in this product are below the maximum concentration values (also referred to as the threshold limits) permitted for such substances, or are used in an exempted application, in accordance with EU Directive 2011/65/EC (RoHS2), as implemented January 2, 2013. RoHS Declarations for this product can be obtained from your Cree LED representative or from the [Product Ecology](#) section of the Cree LED website.

Vision Advisory

WARNING: Do not look at an exposed lamp in operation. Eye injury can result.

PACKAGING

The boxes are not water resistant and they must be kept away from water and moisture. The LEDs are packed in cardboard boxes after packaging in normal or anti-electrostatic bags. Cardboard boxes will be used to protect the LEDs from mechanical shocks during transportation.

The reel pack is applied in SMD LED.

Maximum 1,700 pcs per reel.

