

CLM2D-CPC: PLCC4 Cyan SMD LEDs



PRODUCT DESCRIPTION

SMD LEDs is packaged in the industry standard package. These LEDs have high reliability performance and are designed to work under a wide range of environmental conditions. This high reliability feature makes them ideally suited to be used in architectural lighting application conditions

Cree LED has been certified in accordance with ISO/IATF16949.

FEATURES

- Size (mm): 3.2 x 2.8
- Color and Typical Dominant Wavelength:
Cyan (500-512.5nm)
- Viewing angles:
30 degree minimum
- Moisture Sensitivity Level: 5a
- Lead - Free
- RoHS Compliant
- Untinted Diffused Lens

APPLICATIONS

- Channel Letter
- Architectural Lighting

ABSOLUTE MAXIMUM RATINGS ($T_A = 25^\circ\text{C}$)

Items	Symbol	Absolute Maximum Rating	Unit
Forward Current	I_F	35	mA
Peak Forward Current ^{Note1}	I_{FP}	100	mA
Reverse Voltage	V_R	5	V
Power Dissipation	P_D	140	mW
Operation Temperature	T_{opr}	-40 ~ +100	$^\circ\text{C}$
Storage Temperature	T_{stg}	-40 ~ +100	$^\circ\text{C}$
Junction Temperature	T_J	110	$^\circ\text{C}$
Junction/Ambient	R_{THJA}	400	$^\circ\text{C}/\text{W}$
Junction/Solder Point	R_{THJS}	180	$^\circ\text{C}/\text{W}$
Electrostatic Discharge Classification(MIL-STD-883E)	ESD	1000V	

Note:

1. Pulse width ≤ 0.1 msec, duty $\leq 1/10$.

TYPICAL ELECTRICAL & OPTICAL CHARACTERISTICS ($T_A = 25^\circ\text{C}$)

Characteristics	Symbol	Condition	Unit	Minimum	Typical	Maximum
Forward Voltage	V_F	$I_F = 20$ mA	V		3.2	4.0
Reverse Current	I_R	$V_R = 5$ V	μA			10
Dominant Wavelength	λ_D	$I_F = 20$ mA	nm	500	506	512.5
Luminous Intensity	I_V	$I_F = 20$ mA	mcd	3550	4800	
50% Power Angle	$2\theta_{1/2}$	$I_F = 20$ mA	deg	30		

- * Continuous reverse voltage can cause LED damage.

INTENSITY BIN LIMIT

Cyan (20 mA)		
Bin Code	Min.(mcd)	Max.(mcd)
Yb	3550	4500
Z0	4500	5600
A0	5600	7100

* Tolerance of measurement of luminous intensity is $\pm 10\%$

COLOR BIN LIMIT

Cyan (20 mA)		
Bin Code	Min.(nm)	Max.(nm)
G3	500	505
G01	502.5	507.5
G4	505	510
G12	507.5	512.5

* Tolerance of measurement of dominant wavelength is ± 1 nm.

ORDER CODE TABLE

Color	Kit Number	Luminous Intensity (mcd)		Dominant Wavelength				Package
		Min.	Max.	Color Bin	Min.(nm)	Color Bin	Max.(nm)	
Cyan	CLM2D-CPC-CYbA03123	3550	7100	G3	500	G12	512.5	Reel
	CLM2D-CPC-CYbA0343	3550	7100	G3	500	G4	510	Reel

Notes:

- The above kit numbers represent order codes that include multiple intensity-bin and color-bin codes. Only one intensity-bin code and one color-bin code will be shipped on each bulk. Single intensity-bin code and single color-bin codes will not be orderable.
- Please refer to the [HB LED Lamp Reliability Test Standards](#) document for reliability test conditions.
- Please refer to the [HB LED Lamp Soldering & Handling](#) document for information about how to use this LED product safely.

GRAPHS

The data below are collected from statistical figures that do not necessarily correspond to the actual parameters of each single LED. Hence, these data will be changed without further notice.

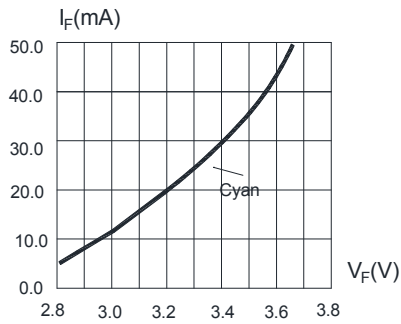

FIG.1 FORWARD CURRENT VS. FORWARD VOLTAGE.

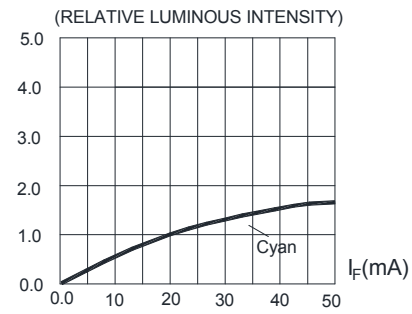

FIG.2 RELATIVE LUMINOUS INTENSITY VS. FORWARD CURRENT

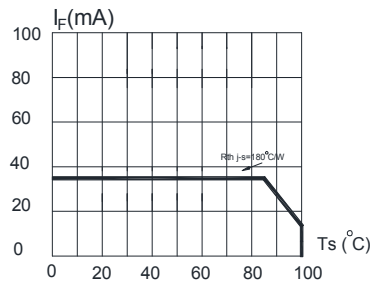

FIG.3 MAXIMUM FORWARD DC CURRENT VS SOLDER TEMPERATURE ($T_{jmax}=110^{\circ}C$)

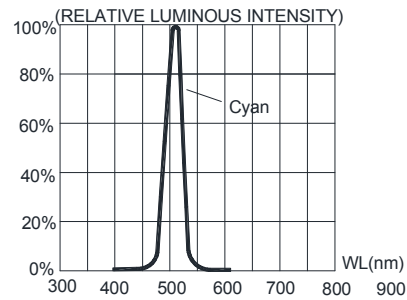

FIG.4 RELATIVE LUMINOUS INTENSITY VS. WAVELENGTH.

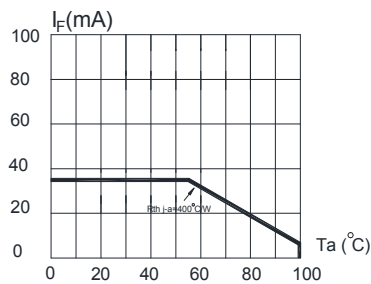

FIG.5 MAXIMUM FORWARD DC CURRENT VS AMBIENT TEMPERATURE ($T_{jmax}=110^{\circ}C$)

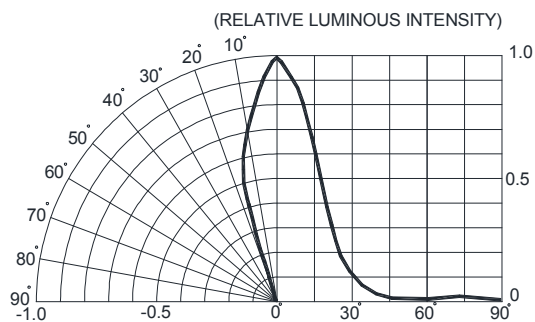
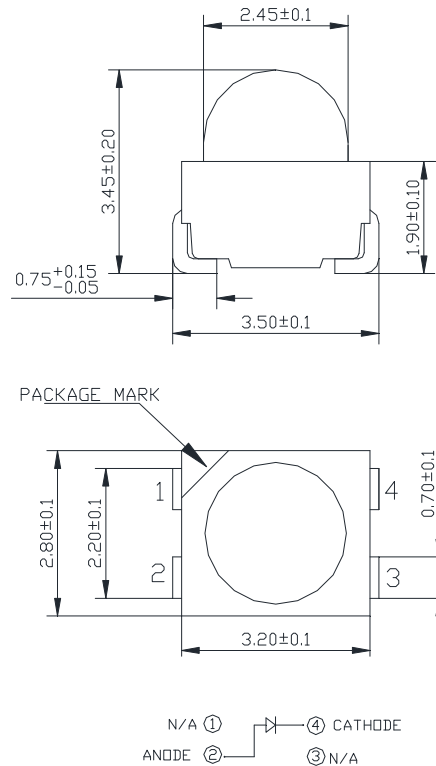

FIG.6 FAR FIELD PATTERN

MECHANICAL DIMENSIONS

All dimensions are in mm.



NOTES

RoHS Compliance

The levels of RoHS restricted materials in this product are below the maximum concentration values (also referred to as the threshold limits) permitted for such substances, or are used in an exempted application, in accordance with EU Directive 2011/65/EC (RoHS2), as implemented January 2, 2013. RoHS Declarations for this product can be obtained from your Cree LED representative or from the [Product Ecology](#) section of the Cree LED website.

Vision Advisory

WARNING: Do not look at an exposed lamp in operation. Eye injury can result.

KIT NUMBER SYSTEM

Cree LED lamps are tested and sorted into performance bins. A bin is specified by ranges of color, forward voltage, and brightness. Sorted LEDs are packaged for shipping in various convenient options.

Cree LEDs are sold by order codes in combinations of bins called kits. Order codes are configured in the following manner:

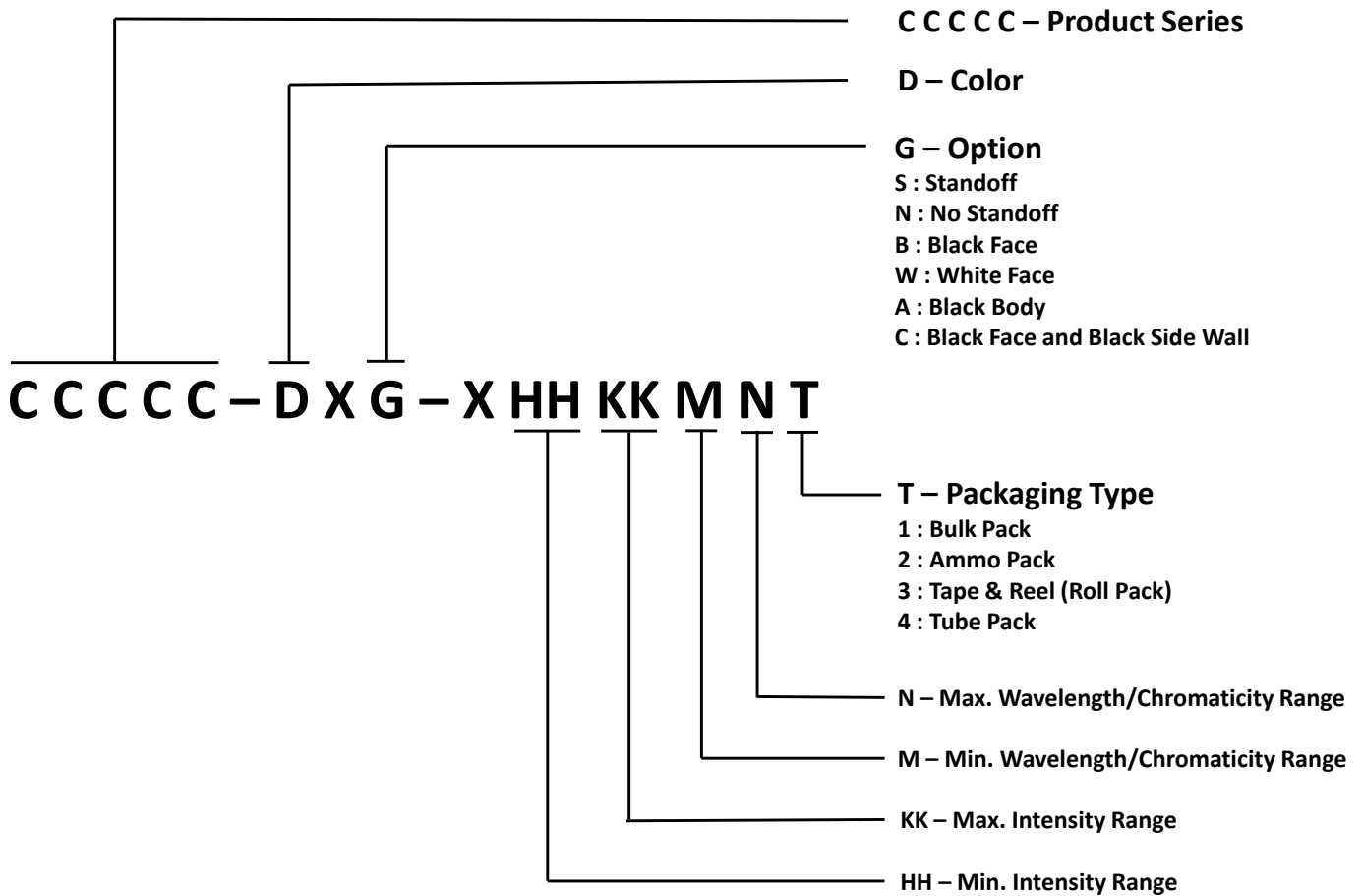

REFLOW SOLDERING

- The CLM2D-CPC is rated as a MSL 5a product.
- The recommended floor life out of bag is 24hrs.
- The temperature profile is as below.

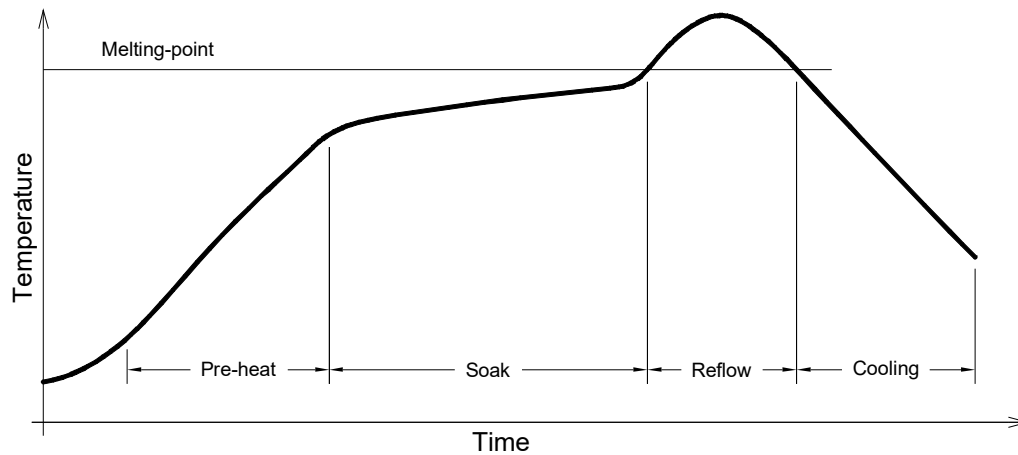

Use only with CLM2D-CPC

Solder
Average ramp-up rate = 4 °C/second max.
Soak temperature = 150°C-200°C
Soak time = 120 seconds max.
Duration above 217 °C = 60 seconds max.
Peak temperature = 250°C max
Time within 5 °C of peak temperature = 10 seconds max.
Ramp-down rate = 6 °C/second max.

- The packaging sizes of these SMD products are very small and the resin is still soft after solidification. Users are required to handle with care. Never touch the resin surface of SMD products.
- To avoid damaging the product's surface and interior device, it is recommended to choose a special nozzle to pick up the SMD products during the process of SMT production. If handling is necessary, take special care when picking up these products. The following method is necessary:
- Please refer to the [HB LED Lamp Soldering & Handling](#) document for information about how to use this LED product safely.

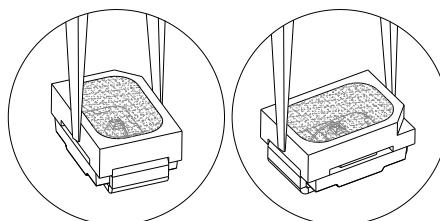

PACKAGING

- The LEDs are packed in cardboard boxes after packaging in normal or anti-electrostatic bags.
- Cardboard boxes will be used to protect the LEDs from mechanical shock during transportation.
- The boxes are not water resistant, and they must be kept away from water and moisture.
- The reel pack is applied in SMD LED.
- Max 2300 pcs per reel.

