

# Silicon Carbide (SiC) Diodes

## - EliteSiC, TO247-3, 50 A, 1200 V SiC Merged PiN-Schottky (MPS) Diode

### UJ3D1250K

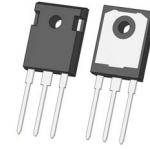

TO247-3 15.90x20.96x5.03, 5.44P  
CASE 340AK

#### Description

onsemi offers the 3<sup>rd</sup> generation of high performance SiC Merged-PiN-Schottky (MPS) diodes. With zero reverse recovery charge and 175 °C maximum junction temperature, these diodes are ideally suited for high frequency and high efficiency power systems with minimum cooling requirements.

#### Features

- Maximum Operating Temperature of 175 °C
- Easy Paralleling
- Extremely Fast Switching Not Dependent on Temperature
- No Reverse or Forward Recovery
- Enhanced Surge Current Capability, MPS Structure
- 100% UIS Tested
- This Device is Halogen Free and RoHS Compliant with Exemption 7a, Pb-Free 2LI (on second level interconnection)

#### Typical Applications

- Power Converters
- Industrial Motor Drives
- Switch Mode Power Supplies
- Power Factor Correction Modules

#### MARKING DIAGRAM

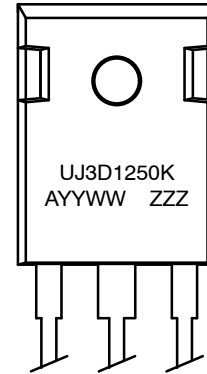

UJ3D1250K	= Specific Device Code
A	= Assembly Location
YY	= Year
WW	= Work Week
ZZZ	= Lot ID

#### PIN CONNECTIONS

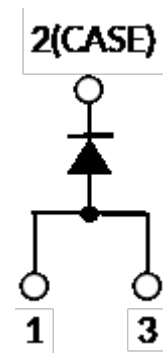

#### ORDERING INFORMATION

See detailed ordering and shipping information on page 4 of this data sheet.

# UJ3D1250K

## MAXIMUM RATINGS

Parameter	Symbol	Test Conditions	Value	Unit
DC Blocking Voltage	$V_R$		1200	V
Repetitive Peak Reverse Voltage, $T_J = 25\text{ }^\circ\text{C}$	$V_{RRM}$		1200	V
Surge Peak Reverse Voltage	$V_{RSM}$		1200	V
Maximum DC Forward Current	$I_F$	$T_C = 112\text{ }^\circ\text{C}$	50	A
Non-Repetitive Forward Surge Current Sine Half-wave	$I_{FSM}$	$T_C = 25\text{ }^\circ\text{C}$ , $t_p = 10\text{ ms}$	275	A
Repetitive Forward Surge Current Sine Half-Wave, $D=0.1$	$I_{FRM}$	$T_C = 25\text{ }^\circ\text{C}$ , $t_p = 10\text{ ms}$	163.5	A
		$T_C = 110\text{ }^\circ\text{C}$ , $t_p = 10\text{ ms}$	99.6	
Non-Repetitive Peak Forward Current	$I_{F,max}$	$T_C = 25\text{ }^\circ\text{C}$ , $t_p = 10\text{ }\mu\text{s}$	2400	A
		$T_C = 110\text{ }^\circ\text{C}$ , $t_p = 10\text{ }\mu\text{s}$	2400	
$i^2t$ Value	$\int i^2 dt$	$T_C = 25\text{ }^\circ\text{C}$ , $t_p = 10\text{ ms}$	378	$\text{A}^2\text{s}$
Power Dissipation	$P_{tot}$	$T_C = 25\text{ }^\circ\text{C}$	319	W
		$T_C = 112\text{ }^\circ\text{C}$	134	
Maximum Junction Temperature	$T_{J,max}$		175	$^\circ\text{C}$
Operating and Storage Temperature	$T_J$ , $T_{STG}$		-55 to 175	$^\circ\text{C}$
Soldering Temperatures, Wave Soldering Only Allowed at Leads	$T_{sold}$	1.6 mm From Case for 10s	260	$^\circ\text{C}$

Stresses exceeding those listed in the Maximum Ratings table may damage the device. If any of these limits are exceeded, device functionality should not be assumed, damage may occur and reliability may be affected.

## THERMAL CHARACTERISTICS

Parameter	Symbol	Test Conditions	Min	Typ	Max	Unit
Thermal Resistance, Junction-to-Case	$R_{\theta JC}$		-	0.36	0.47	$^\circ\text{C/W}$

## ELECTRICAL CHARACTERISTICS ( $T_J = +25\text{ }^\circ\text{C}$ unless otherwise specified)

Parameter	Symbol	Test Conditions	Min	Typ	Max	Unit
Forward Voltage	$V_F$	$I_F = 50\text{ A}$ , $T_J = 25\text{ }^\circ\text{C}$	-	1.5	1.7	V
		$I_F = 50\text{ A}$ , $T_J = 150\text{ }^\circ\text{C}$	-	1.95	2.4	
		$I_F = 50\text{ A}$ , $T_J = 175\text{ }^\circ\text{C}$	-	2.2	2.7	
Reverse Current	$I_R$	$V_R = 1200\text{ V}$ , $T_J = 25\text{ }^\circ\text{C}$	-	52	400	$\mu\text{A}$
		$V_R = 1200\text{ V}$ , $T_J = 175\text{ }^\circ\text{C}$	-	900	-	
Total Gate Leakage Current (Note 1)	$Q_C$	$V_R = 800\text{ V}$	-	240	-	nC
Total Capacitance	C	$V_R = 1\text{ V}$ , $f = 1\text{ MHz}$	-	2340	-	pF
		$V_R = 400\text{ V}$ , $f = 1\text{ MHz}$	-	224	-	
		$V_R = 800\text{ V}$ , $f = 1\text{ MHz}$	-	198	-	
Capacitance Stored Energy	$E_C$	$V_R = 800\text{ V}$	-	72	-	$\mu\text{J}$

Product parametric performance is indicated in the Electrical Characteristics for the listed test conditions, unless otherwise noted. Product performance may not be indicated by the Electrical Characteristics if operated under different conditions.

1.  $Q_C$  is independent on  $T_J$ ,  $di_F/dt$ , and  $I_F$  as shown in the application note AND90316/D.

# UJ3D1250K

## TYPICAL PERFORMANCE DIAGRAMS

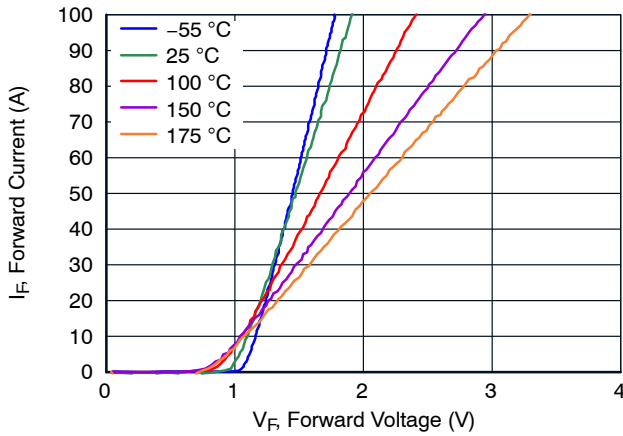

Figure 1. Typical Forward Characteristics

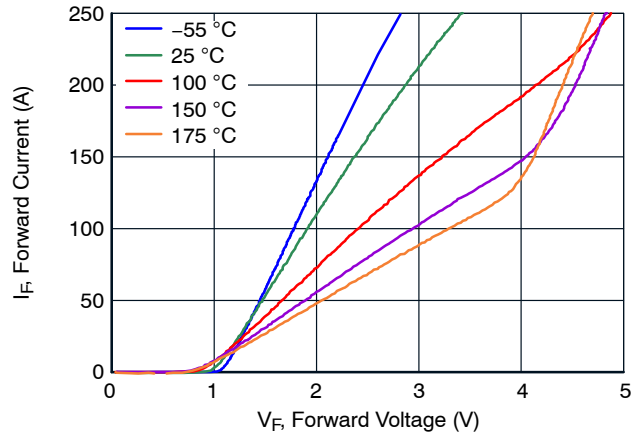

Figure 2. Typical Forward Characteristics in Surge Current

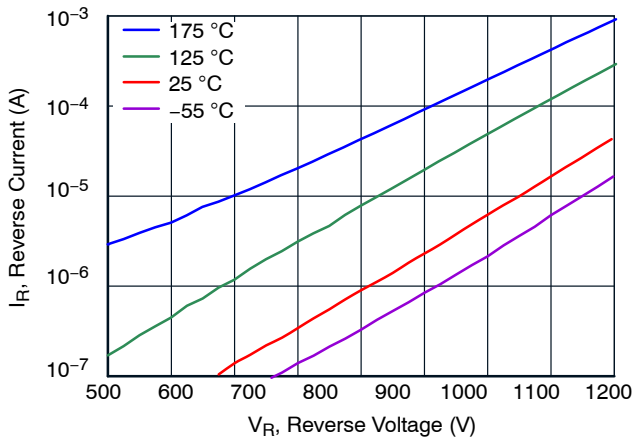

Figure 3. Typical Reverse Characteristics

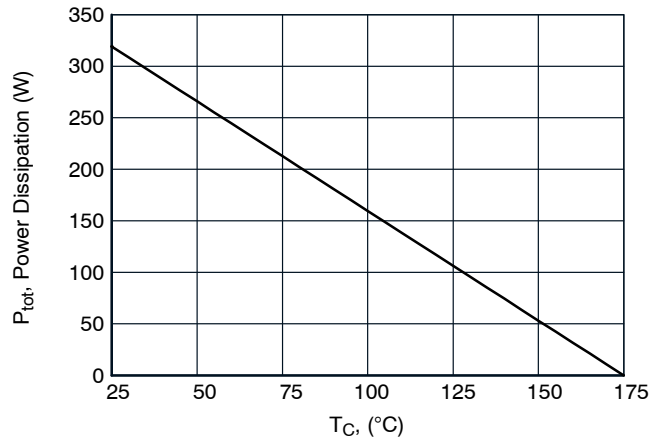

Figure 4. Power Dissipation

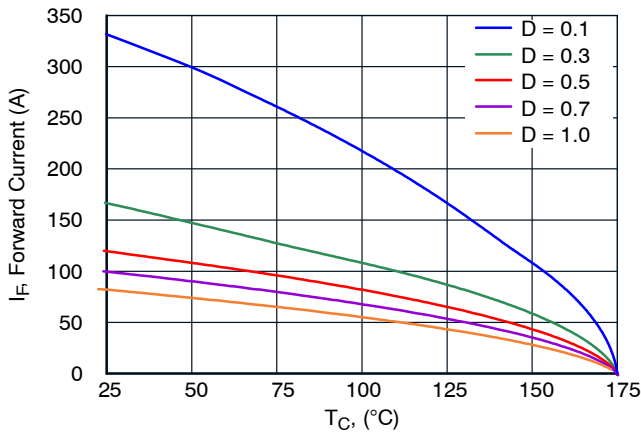

Figure 5. Diode Forward Current

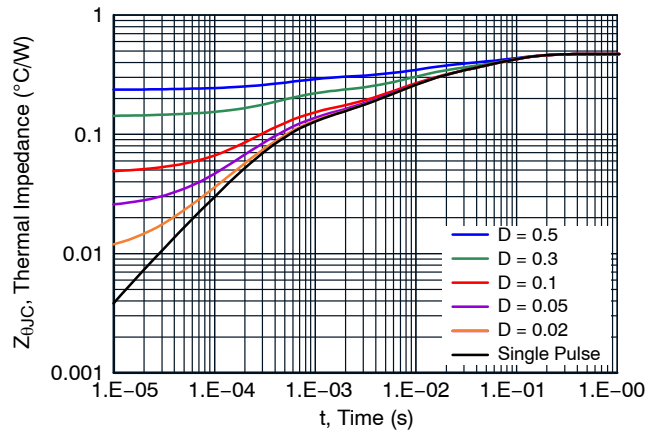
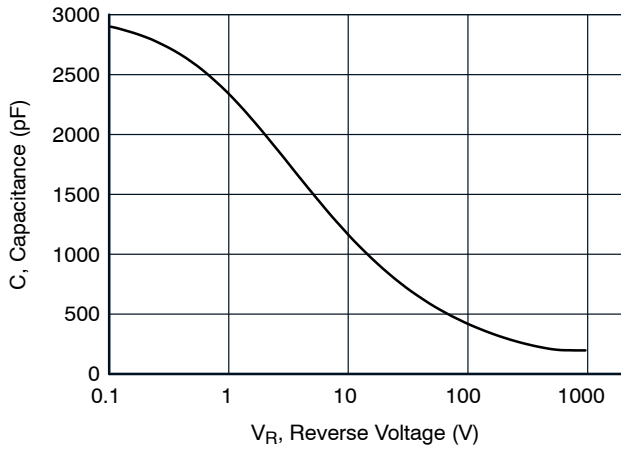

Figure 6. Maximum Transient Thermal Impedance

# UJ3D1250K

## TYPICAL PERFORMANCE DIAGRAMS (continued)



**Figure 7. Capacitance vs. Reverse Voltage at 1 MHz**

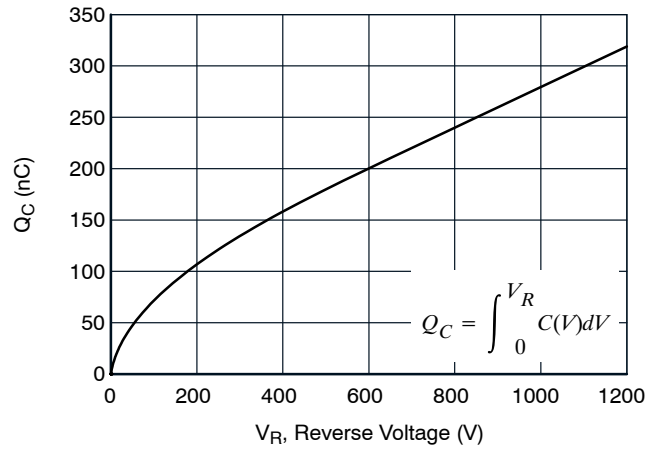

**Figure 8. Typical Capacitive Charge vs. Reverse Voltage**

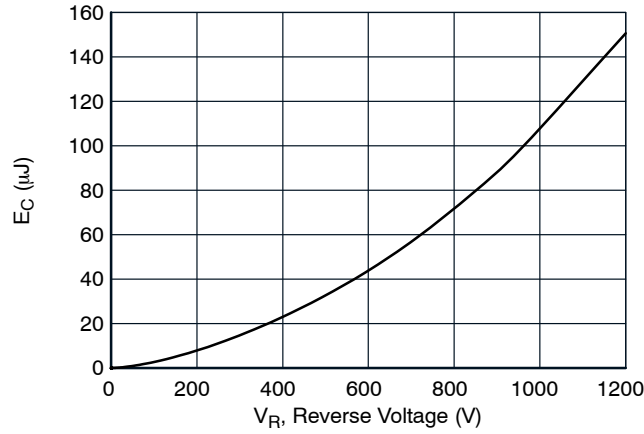

**Figure 9. Typical Capacitance Stored Energy vs. Reverse Voltage**

### ORDERING INFORMATION

Part Number	Marking	Package	Shipping
UJ3D1250K	UJ3D1250K	TO247-3 15.90x20.96x5.03, 5.44P (Pb-Free, Halogen Free)	600 / Tube

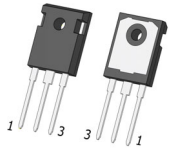

TO247-3 15.90x20.96x5.03, 5.44P  
CASE 340AK  
ISSUE B

DATE 14 APR 2025

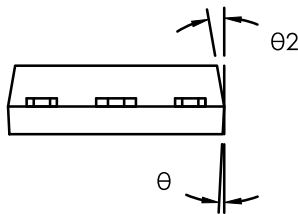
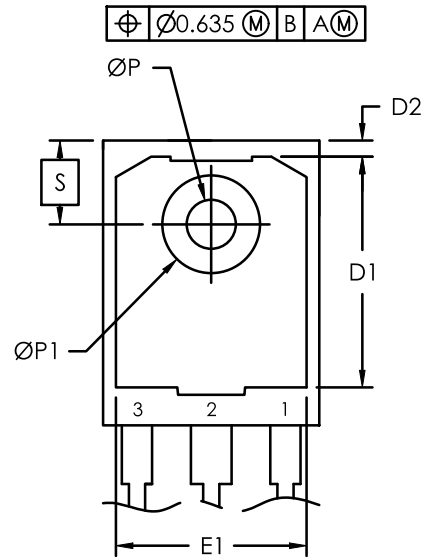
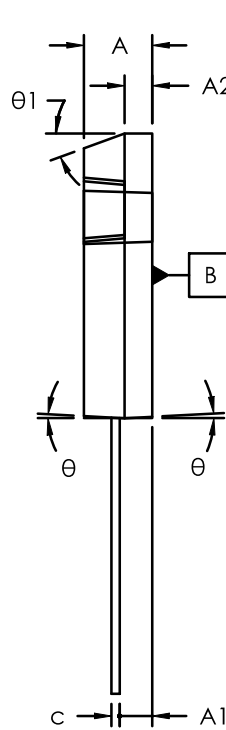
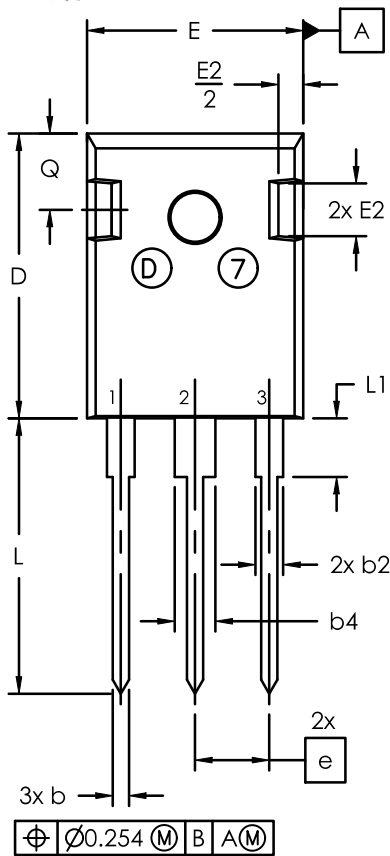

NOTE:

1. Dimensioning and tolerancing as per ASME Y14.5 - 2018
2. Controlling dimension : millimeters
3. Package Outline in compliance with JEDEC standard var. AD.
4. Dimensions D & E does not include mold flash.
5. ØP to have max draft angle of 1.7° to the top with max. hole diameter of 3.91mm.

SYM	millimeters		
	MIN	NOM	MAX
A	4.70	5.03	5.31
A1	2.21	2.40	2.59
A2	1.50	2.03	2.49
b	0.99	1.20	1.40
b2	1.65	2.03	2.39
b4	2.59	3.00	3.43
c	0.38	0.60	0.89
D	20.70	20.96	21.46
D1	13.08	—	—
D2	0.51	1.19	1.35
E	15.49	15.90	16.26
e	5.44 BSC		
E1	13.00	13.30	13.60
E2	3.43	3.89	5.20
L	19.62	20.27	20.32
L1	—	—	4.50
ØP	3.40	3.60	3.80
ØP1	7.06	7.19	7.39
Q	5.38	5.62	6.20
S	6.15 BSC		
Ø	3°		
Ø1	20°		
Ø2	10°		

DOCUMENT NUMBER:	98AON88794E	Electronic versions are uncontrolled except when accessed directly from the Document Repository. Printed versions are uncontrolled except when stamped "CONTROLLED COPY" in red.
DESCRIPTION:	TO247-3 15.90x20.96x5.03, 5.44P	PAGE 1 OF 1

onsemi and ONSEMI are trademarks of Semiconductor Components Industries, LLC dba onsemi or its subsidiaries in the United States and/or other countries. onsemi reserves the right to make changes without further notice to any products herein. onsemi makes no warranty, representation or guarantee regarding the suitability of its products for any particular purpose, nor does onsemi assume any liability arising out of the application or use of any product or circuit, and specifically disclaims any and all liability, including without limitation special, consequential or incidental damages. onsemi does not convey any license under its patent rights nor the rights of others.

**onsemi**, **Onsemi**, and other names, marks, and brands are registered and/or common law trademarks of Semiconductor Components Industries, LLC dba "**onsemi**" or its affiliates and/or subsidiaries in the United States and/or other countries. **onsemi** owns the rights to a number of patents, trademarks, copyrights, trade secrets, and other intellectual property. A listing of **onsemi**'s product/patent coverage may be accessed at [www.onsemi.com/site/pdf/Patent-Marking.pdf](http://www.onsemi.com/site/pdf/Patent-Marking.pdf). **onsemi** reserves the right to make changes at any time to any products or information herein, without notice. The information herein is provided "as-is" and **onsemi** makes no warranty, representation or guarantee regarding the accuracy of the information, product features, availability, functionality, or suitability of its products for any particular purpose, nor does **onsemi** assume any liability arising out of the application or use of any product or circuit, and specifically disclaims any and all liability, including without limitation special, consequential or incidental damages. Buyer is responsible for its products and applications using **onsemi** products, including compliance with all laws, regulations and safety requirements or standards, regardless of any support or applications information provided by **onsemi**. "Typical" parameters which may be provided in **onsemi** data sheets and/or specifications can and do vary in different applications and actual performance may vary over time. All operating parameters, including "Typicals" must be validated for each customer application by customer's technical experts. **onsemi** does not convey any license under any of its intellectual property rights nor the rights of others. **onsemi** products are not designed, intended, or authorized for use as a critical component in life support systems or any FDA Class 3 medical devices or medical devices with a same or similar classification in a foreign jurisdiction or any devices intended for implantation in the human body. Should Buyer purchase or use **onsemi** products for any such unintended or unauthorized application, Buyer shall indemnify and hold **onsemi** and its officers, employees, subsidiaries, affiliates, and distributors harmless against all claims, costs, damages, and expenses, and reasonable attorney fees arising out of, directly or indirectly, any claim of personal injury or death associated with such unintended or unauthorized use, even if such claim alleges that **onsemi** was negligent regarding the design or manufacture of the part. **onsemi** is an Equal Opportunity/Affirmative Action Employer. This literature is subject to all applicable copyright laws and is not for resale in any manner.

## ADDITIONAL INFORMATION

### TECHNICAL PUBLICATIONS:

Technical Library: [www.onsemi.com/design/resources/technical-documentation](http://www.onsemi.com/design/resources/technical-documentation)  
onsemi Website: [www.onsemi.com](http://www.onsemi.com)

### ONLINE SUPPORT: [www.onsemi.com/support](http://www.onsemi.com/support)

For additional information, please contact your local Sales Representative at [www.onsemi.com/support/sales](http://www.onsemi.com/support/sales)

