

Silicon Carbide (SiC) Diode – EliteSiC, TO247-2, 20 A, 1200 V SiC Merged PiN-Schottky (MPS) Diode UJ3D1220K2

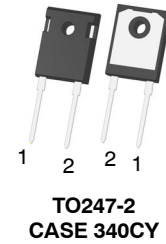

Description

onsemi offers the 3rd generation of high performance SiC Merged-PiN-Schottky (MPS) diodes. With zero reverse recovery charge and 175 °C maximum junction temperature, these diodes are ideally suited for high frequency and high efficiency power systems with minimum cooling requirements.

Features

- Maximum Operating Temperature of 175 °C
- Easy Paralleling
- Extremely Fast Switching not Dependent on Temperature
- No Reverse or Forward Recovery
- Enhanced Surge Current Capability, MPS Structure
- 100% UIS Tested
- This Device is Halogen Free and RoHS Compliant with Exemption 7a, Pb-Free 2LI (on second level interconnection)

Typical Applications

- Power Converters
- Industrial Motor Drives
- Switch Mode Power Supplies
- Power Factor Correction Modules

MARKING DIAGRAM

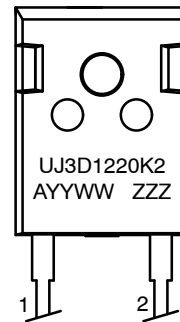

UJ3D1220K2	= Specific Device Code
A	= Assembly Location
YY	= Year
WW	= Work Week
ZZZ	= Lot ID

PIN CONNECTIONS

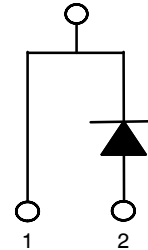

ORDERING INFORMATION

See detailed ordering and shipping information on page 4 of this data sheet.

UJ3D1220K2

MAXIMUM RATINGS

Parameter	Symbol	Test Conditions	Value	Unit
DC Blocking Voltage	V_R		1200	V
Repetitive Peak Reverse Voltage, $T_J = 25\text{ }^\circ\text{C}$	V_{RRM}		1200	V
Surge Peak Reverse Voltage	V_{RSM}		1200	V
Maximum DC Forward Current	I_F	$T_C = 135\text{ }^\circ\text{C}$	20	A
Non-repetitive Forward Surge Current Sine Halfwave	I_{FSM}	$T_C = 25\text{ }^\circ\text{C}$, $t_p = 10\text{ ms}$	190	A
		$T_C = 110\text{ }^\circ\text{C}$, $t_p = 10\text{ ms}$	180	
Repetitive Forward Surge Current Sine Halfwave, $D = 0.1$	I_{FRM}	$T_C = 25\text{ }^\circ\text{C}$, $t_p = 10\text{ ms}$	71.9	A
		$T_C = 110\text{ }^\circ\text{C}$, $t_p = 10\text{ ms}$	40.9	
Non-repetitive Peak Forward Current	$I_{F, max}$	$T_C = 25\text{ }^\circ\text{C}$, $t_p = 10\text{ }\mu\text{s}$	1300	A
		$T_C = 110\text{ }^\circ\text{C}$, $t_p = 10\text{ }\mu\text{s}$	1300	
i^2t Value	$\int i^2 dt$	$T_C = 25\text{ }^\circ\text{C}$, $t_p = 10\text{ ms}$	181	A^2s
		$T_C = 110\text{ }^\circ\text{C}$, $t_p = 10\text{ ms}$	162	
Power Dissipation	P_{tot}	$T_C = 25\text{ }^\circ\text{C}$	205	W
		$T_C = 135\text{ }^\circ\text{C}$	55	
Maximum Junction Temperature	$T_{J, max}$		175	$^\circ\text{C}$
Operating and Storage Temperature	T_J, T_{STG}		-55 to 175	$^\circ\text{C}$
Soldering Temperatures, Wavesoldering only Allowed at Leads	T_{sold}	1.6 mm from case for 10 s	260	$^\circ\text{C}$

Stresses exceeding those listed in the Maximum Ratings table may damage the device. If any of these limits are exceeded, device functionality should not be assumed, damage may occur and reliability may be affected.

THERMAL CHARACTERISTICS

Parameter	Symbol	Test Conditions	Min	Typ	Max	Unit
Thermal Resistance, Junction-to-Case	$R_{\theta JC}$		-	0.56	0.73	$^\circ\text{C/W}$

ELECTRICAL CHARACTERISTICS ($T_J = +25\text{ }^\circ\text{C}$ unless otherwise specified)

Parameter	Symbol	Test Conditions	Min	Typ	Max	Unit
Forward Voltage	V_F	$I_F = 20\text{ A}$, $T_J = 25\text{ }^\circ\text{C}$	-	1.52	1.7	V
		$I_F = 20\text{ A}$, $T_J = 150\text{ }^\circ\text{C}$	-	2.15	-	
		$I_F = 20\text{ A}$, $T_J = 175\text{ }^\circ\text{C}$	-	2.25	-	
Reverse Current	I_R	$V_R = 1200\text{ V}$, $T_J = 25\text{ }^\circ\text{C}$	-	18	190	μA
		$V_R = 1200\text{ V}$, $T_J = 175\text{ }^\circ\text{C}$	-	500	-	
Total Capacitive Charge (Note 1)	Q_C	$V_R = 800\text{ V}$	-	83	-	nC
Total Capacitance	C	$V_R = 1\text{ V}$, $f = 1\text{ MHz}$	-	810	-	pF
		$V_R = 400\text{ V}$, $f = 1\text{ MHz}$	-	75	-	
		$V_R = 800\text{ V}$, $f = 1\text{ MHz}$	-	69	-	
Capacitance Stored Energy	E_C	$V_R = 800\text{ V}$	-	24.5	-	μJ

Product parametric performance is indicated in the Electrical Characteristics for the listed test conditions, unless otherwise noted. Product performance may not be indicated by the Electrical Characteristics if operated under different conditions.

1. Q_C is independent on T_J , di_F/dt , and I_F as shown in the application note [AND90316/D](#)

TYPICAL PERFORMANCE DIAGRAMS

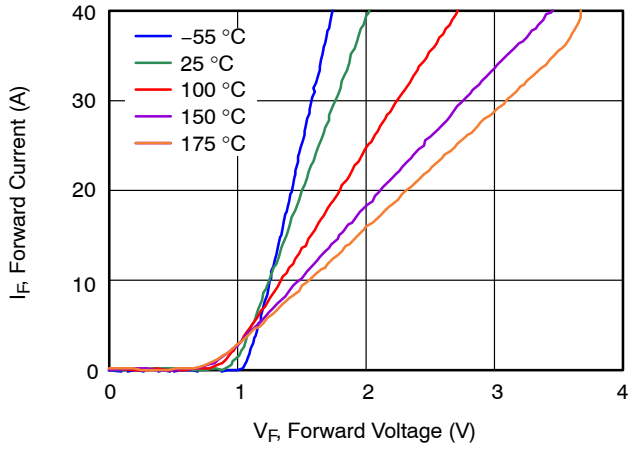

Figure 1. Typical Forward Characteristics

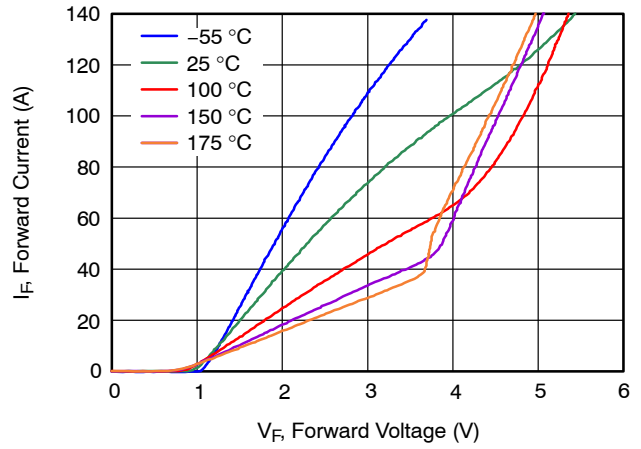

Figure 2. Typical Forward Characteristics in Surge Current

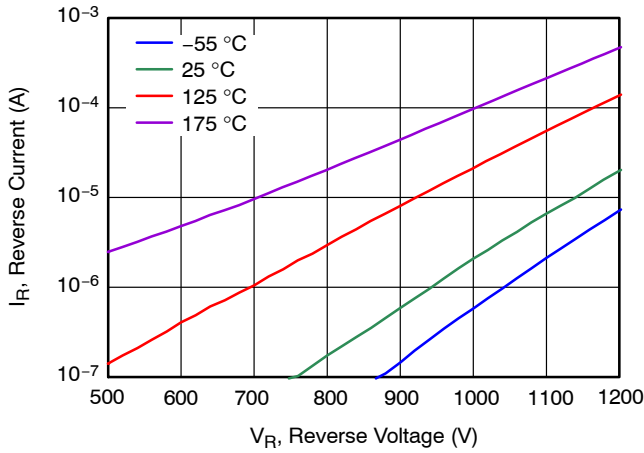

Figure 3. Typical Reverse Characteristics

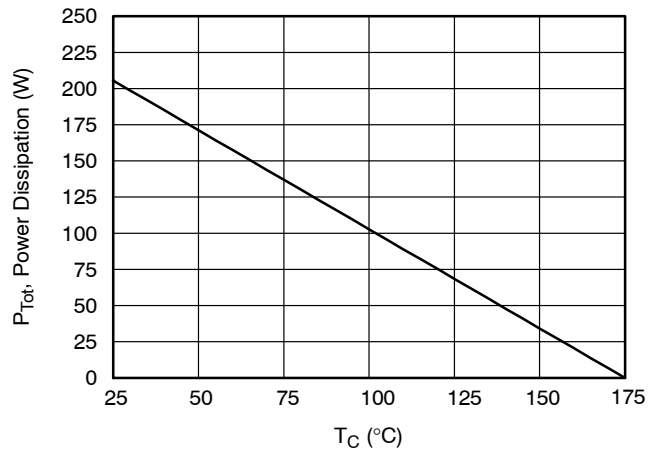

Figure 4. Power Dissipation

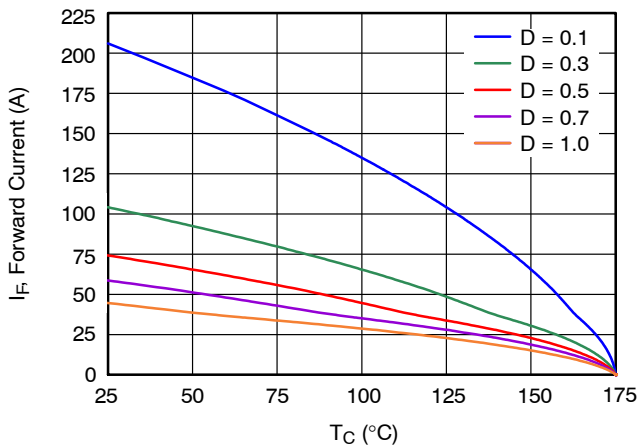

Figure 5. Diode Forward Current

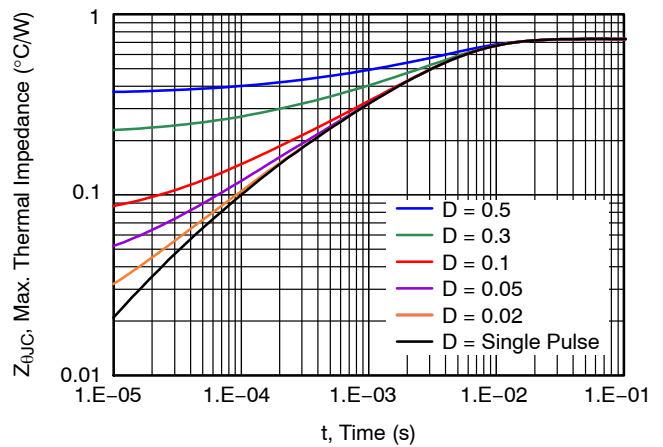

Figure 6. Maximum Transient Thermal Impedance

UJ3D1220K2

TYPICAL PERFORMANCE DIAGRAMS (continued)

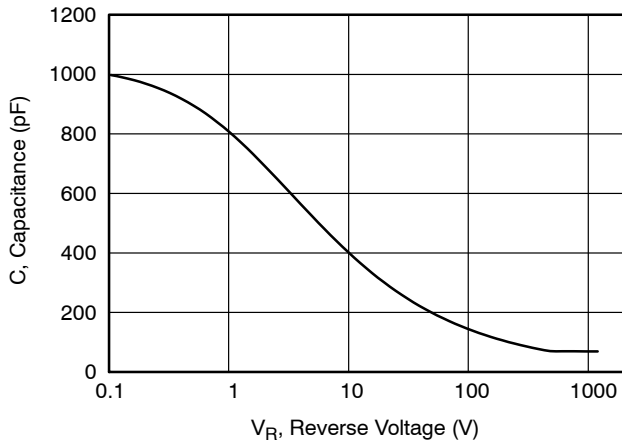

Figure 7. Capacitance vs. Reverse Voltage at 1 MHz

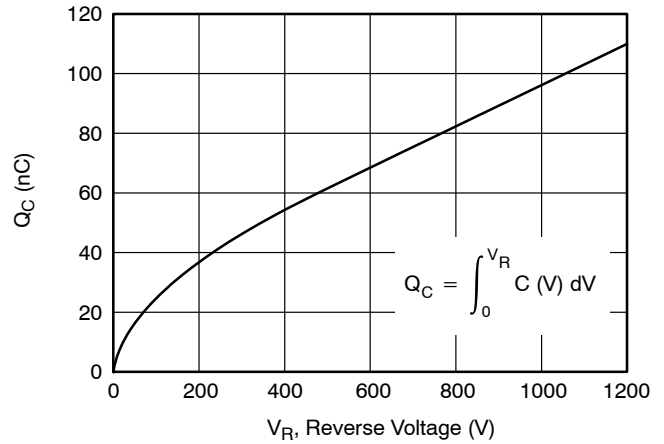

Figure 8. Typical Capacitive Charge vs. Reverse Voltage

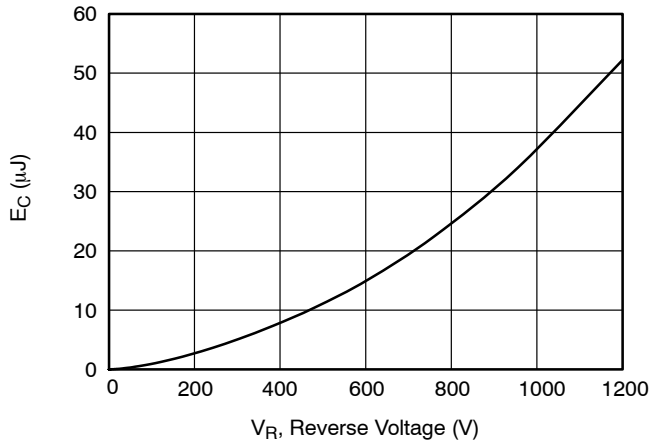

Figure 9. Typical Capacitance Stored Energy vs. Reverse Voltage

ORDERING INFORMATION

Part Number	Marking	Package	Shipping
UJ3D1220K2	UJ3D1220K2	TO247-2 (Pb-Free, Halogen Free)	600 Units / Tube

UJ3D1220K2

REVISION HISTORY

Revision	Description of Changes	Date
C	Acquired the original Qorvo JFET Division Data Sheet and updated the main document title to comply with onsemi standards for SiC products.	1/15/2025
3	Converted the Data Sheet to onsemi format.	5/15/2025

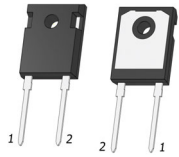

TO247-2 15.90x20.96x5.03, 5.44P
CASE 340CY
ISSUE B

DATE 16 APR 2025

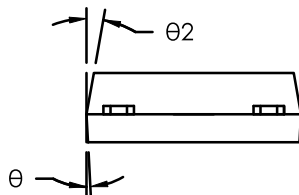
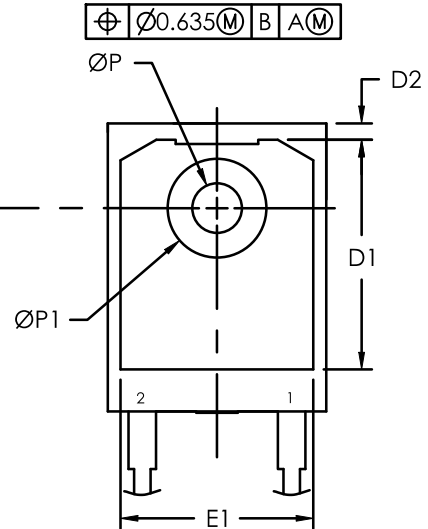
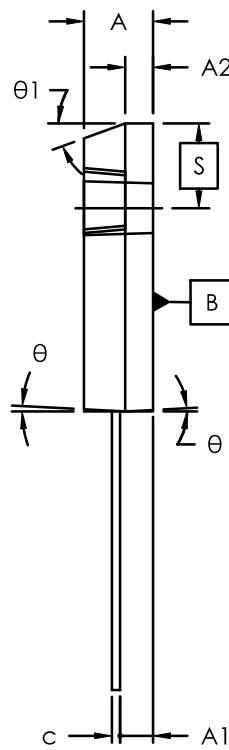
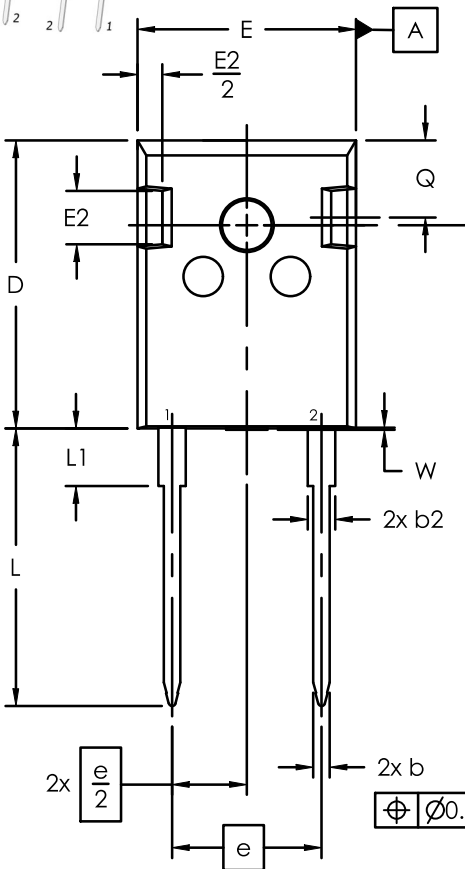

SYM	millimeters		
	MIN	NOM	MAX
A	4.70	5.03	5.31
A1	2.21	2.40	2.59
A2	1.50	2.03	2.49
b	0.99	1.20	1.40
b2	1.65	2.03	2.39
c	0.38	0.60	0.89
D	20.80	20.96	21.46
D1	13.08	-	-
D2	0.51	1.19	1.35
E	15.49	15.90	16.26
e	10.87 BSC		
E1	13.46	-	-
E2	3.43	3.89	3.99
L	19.81	20.19	20.32
L1	-	-	4.50
ØP	3.56	3.60	3.66
ØP1	7.06	7.19	7.39
Q	5.38	5.62	6.20
S	6.17 BSC		
W	-	-	0.15
θ	3°		
θ1	20°		
θ2	10°		

NOTE:

1. Dimensioning and tolerancing as per ASME Y14.5 - 2018
2. Controlling dimension : millimeters
3. Dimension "W" = max. allowable plastic protrusion.
4. Package Outline in compliance with JEDEC standard var. AD.
5. Dimensions D & E does not include mold flash.
6. ØP to have max draft angle of 1.7° to the top with max. hole diameter of 3.91mm.

DOCUMENT NUMBER:	98AON94670G	Electronic versions are uncontrolled except when accessed directly from the Document Repository. Printed versions are uncontrolled except when stamped "CONTROLLED COPY" in red.
DESCRIPTION:	TO247-2 15.90x20.96x5.03, 5.44P	PAGE 1 OF 1

onsemi and ONSEMI are trademarks of Semiconductor Components Industries, LLC dba onsemi or its subsidiaries in the United States and/or other countries. onsemi reserves the right to make changes without further notice to any products herein. onsemi makes no warranty, representation or guarantee regarding the suitability of its products for any particular purpose, nor does onsemi assume any liability arising out of the application or use of any product or circuit, and specifically disclaims any and all liability, including without limitation special, consequential or incidental damages. onsemi does not convey any license under its patent rights nor the rights of others.

onsemi, **Onsemi**, and other names, marks, and brands are registered and/or common law trademarks of Semiconductor Components Industries, LLC dba "**onsemi**" or its affiliates and/or subsidiaries in the United States and/or other countries. **onsemi** owns the rights to a number of patents, trademarks, copyrights, trade secrets, and other intellectual property. A listing of **onsemi**'s product/patent coverage may be accessed at www.onsemi.com/site/pdf/Patent-Marking.pdf. **onsemi** reserves the right to make changes at any time to any products or information herein, without notice. The information herein is provided "as-is" and **onsemi** makes no warranty, representation or guarantee regarding the accuracy of the information, product features, availability, functionality, or suitability of its products for any particular purpose, nor does **onsemi** assume any liability arising out of the application or use of any product or circuit, and specifically disclaims any and all liability, including without limitation special, consequential or incidental damages. Buyer is responsible for its products and applications using **onsemi** products, including compliance with all laws, regulations and safety requirements or standards, regardless of any support or applications information provided by **onsemi**. "Typical" parameters which may be provided in **onsemi** data sheets and/or specifications can and do vary in different applications and actual performance may vary over time. All operating parameters, including "Typicals" must be validated for each customer application by customer's technical experts. **onsemi** does not convey any license under any of its intellectual property rights nor the rights of others. **onsemi** products are not designed, intended, or authorized for use as a critical component in life support systems or any FDA Class 3 medical devices or medical devices with a same or similar classification in a foreign jurisdiction or any devices intended for implantation in the human body. Should Buyer purchase or use **onsemi** products for any such unintended or unauthorized application, Buyer shall indemnify and hold **onsemi** and its officers, employees, subsidiaries, affiliates, and distributors harmless against all claims, costs, damages, and expenses, and reasonable attorney fees arising out of, directly or indirectly, any claim of personal injury or death associated with such unintended or unauthorized use, even if such claim alleges that **onsemi** was negligent regarding the design or manufacture of the part. **onsemi** is an Equal Opportunity/Affirmative Action Employer. This literature is subject to all applicable copyright laws and is not for resale in any manner.

ADDITIONAL INFORMATION

TECHNICAL PUBLICATIONS:

Technical Library: www.onsemi.com/design/resources/technical-documentation
onsemi Website: www.onsemi.com

ONLINE SUPPORT: www.onsemi.com/support

For additional information, please contact your local Sales Representative at www.onsemi.com/support/sales

