

# Standard Rectifier Module

$$V_{RRM} = 2 \times 1200 \text{ V}$$

$$I_{FAV} = 36 \text{ A}$$

$$V_F = 1,05 \text{ V}$$

Phase leg

Part number

**MDD26-12N1B**

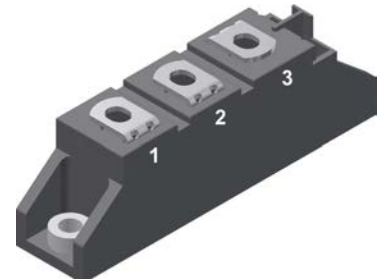

Backside: isolated

 E72873

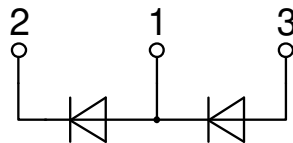

### Features / Advantages:

- Package with DCB ceramic
- Improved temperature and power cycling
- Planar passivated chips
- Very low forward voltage drop
- Very low leakage current

### Applications:

- Diode for main rectification
- For single and three phase bridge configurations
- Supplies for DC power equipment
- Input rectifiers for PWM inverter
- Battery DC power supplies
- Field supply for DC motors

### Package: TO-240AA

- Isolation Voltage: 4800 V~
- Industry standard outline
- RoHS compliant
- Height: 30 mm
- Base plate: DCB ceramic
- Reduced weight
- Advanced power cycling

### Disclaimer Notice

Information furnished is believed to be accurate and reliable. However, users should independently evaluate the suitability of and test each product selected for their own applications. Littelfuse products are not designed for, and may not be used in, all applications. Read complete Disclaimer Notice at [www.littelfuse.com/disclaimer-electronics](http://www.littelfuse.com/disclaimer-electronics).



Rectifier				Ratings			
Symbol	Definition	Conditions	min.	typ.	max.	Unit	
$V_{RSM}$	max. non-repetitive reverse blocking voltage				1300	V	
$V_{RRM}$	max. repetitive reverse blocking voltage				1200	V	
$I_R$	reverse current	$V_R = 1200\text{ V}$			100	$\mu\text{A}$	
		$V_R = 1200\text{ V}$			1,5	mA	
$V_F$	forward voltage drop	$I_F = 40\text{ A}$			1,13	V	
		$I_F = 80\text{ A}$			1,38	V	
		$I_F = 40\text{ A}$	$T_{VJ} = 125^\circ\text{C}$			1,05	V
		$I_F = 80\text{ A}$	$T_{VJ} = 125^\circ\text{C}$			1,27	V
$I_{FAV}$	average forward current	$T_C = 100^\circ\text{C}$			36	A	
$I_{F(RMS)}$	RMS forward current	180° sine			60	A	
$V_{F0}$	threshold voltage	} for power loss calculation only			0,80	V	
$r_F$	slope resistance				6,1	m $\Omega$	
$R_{thJC}$	thermal resistance junction to case				1	K/W	
$R_{thCH}$	thermal resistance case to heatsink			0,2		K/W	
$P_{tot}$	total power dissipation		$T_C = 25^\circ\text{C}$		125	W	
$I_{FSM}$	max. forward surge current	t = 10 ms; (50 Hz), sine	$T_{VJ} = 45^\circ\text{C}$		650	A	
		t = 8,3 ms; (60 Hz), sine	$V_R = 0\text{ V}$		700	A	
		t = 10 ms; (50 Hz), sine	$T_{VJ} = 150^\circ\text{C}$		555	A	
		t = 8,3 ms; (60 Hz), sine	$V_R = 0\text{ V}$		595	A	
$I^2t$	value for fusing	t = 10 ms; (50 Hz), sine	$T_{VJ} = 45^\circ\text{C}$		2,12	kA <sup>2</sup> s	
		t = 8,3 ms; (60 Hz), sine	$V_R = 0\text{ V}$		2,04	kA <sup>2</sup> s	
		t = 10 ms; (50 Hz), sine	$T_{VJ} = 150^\circ\text{C}$		1,54	kA <sup>2</sup> s	
		t = 8,3 ms; (60 Hz), sine	$V_R = 0\text{ V}$		1,48	kA <sup>2</sup> s	
$C_J$	junction capacitance	$V_R = 400\text{ V}; f = 1\text{ MHz}$	$T_{VJ} = 25^\circ\text{C}$		27	pF	



Package TO-240AA				Ratings			
Symbol	Definition	Conditions	min.	typ.	max.	Unit	
$I_{RMS}$	RMS current	per terminal			200	A	
$T_{VJ}$	virtual junction temperature		-40		150	°C	
$T_{op}$	operation temperature		-40		125	°C	
$T_{stg}$	storage temperature		-40		125	°C	
<b>Weight</b>					76	g	
$M_D$	mounting torque		2,5		4	Nm	
$M_T$	terminal torque		2,5		4	Nm	
$d_{Spp/App}$	creepage distance on surface   striking distance through air	terminal to terminal	13,0	9,7		mm	
$d_{Spb/Apb}$		terminal to backside	16,0	16,0		mm	
$V_{ISOL}$	isolation voltage	t = 1 second			4800	V	
		t = 1 minute	50/60 Hz, RMS; $I_{ISOL} \leq 1$ mA		4000	V	

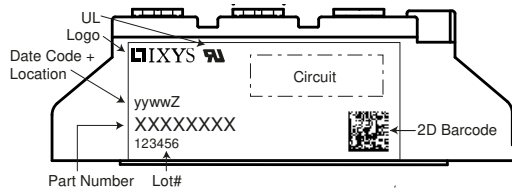

Ordering	Ordering Number	Marking on Product	Delivery Mode	Quantity	Code No.
Standard	MDD26-12N1B	MDD26-12N1B	Box	36	453021

Similar Part	Package	Voltage class
MDD26-08N1B	TO-240AA	800
MDD26-14N1B	TO-240AA	1400
MDD26-16N1B	TO-240AA	1600
MDD26-18N1B	TO-240AA	1800

**Equivalent Circuits for Simulation**

\* on die level

$T_{VJ} = 150^{\circ}\text{C}$

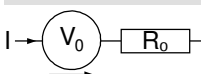

Rectifier

$V_{0\ max}$	threshold voltage	0,8	V
$R_{0\ max}$	slope resistance *	4,9	mΩ



Outlines TO-240AA

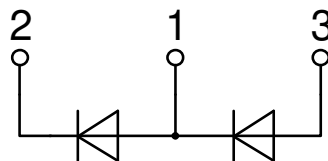
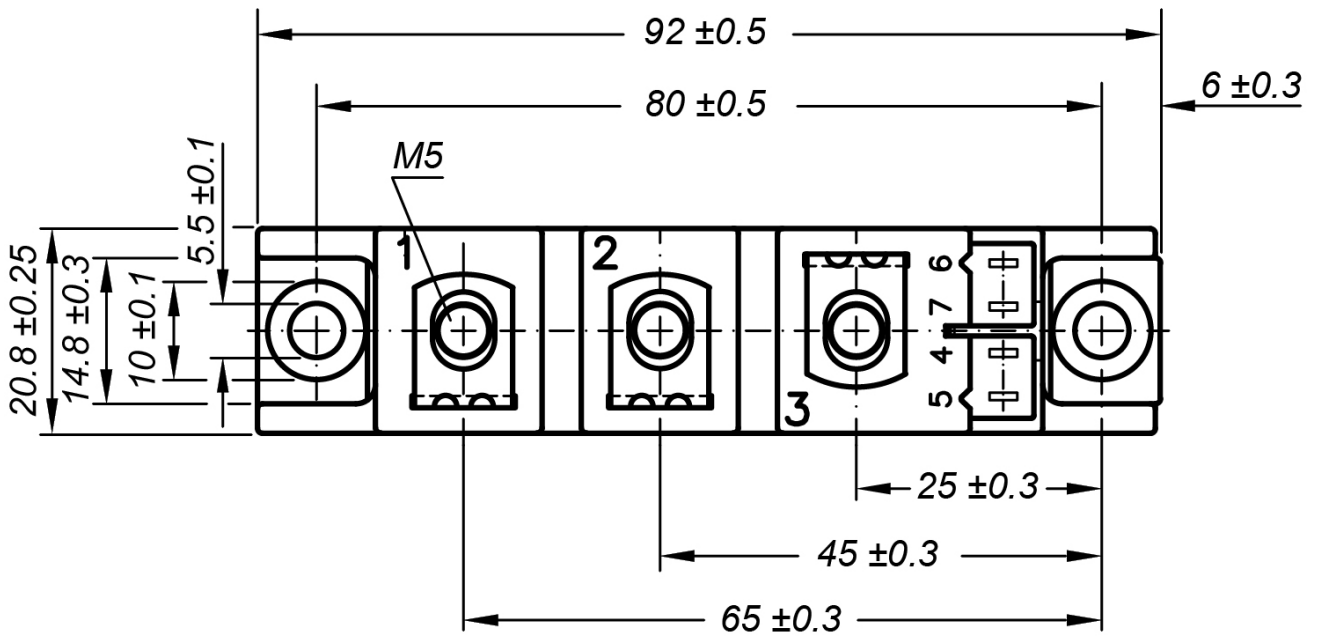
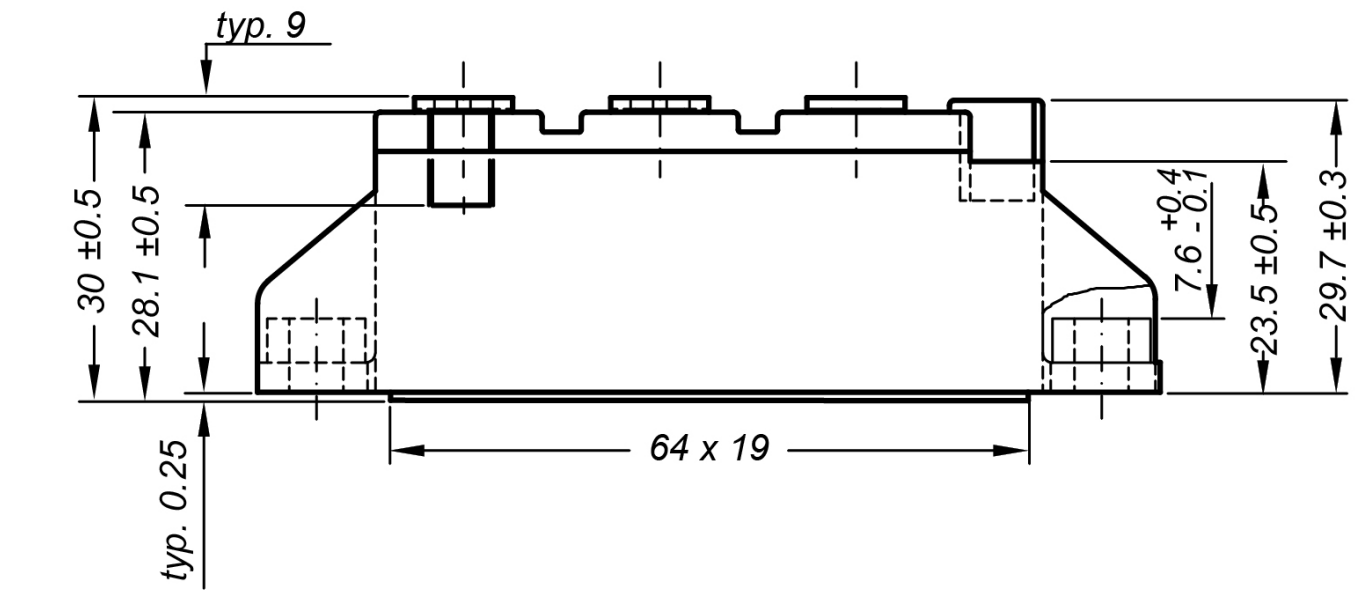



**Rectifier**

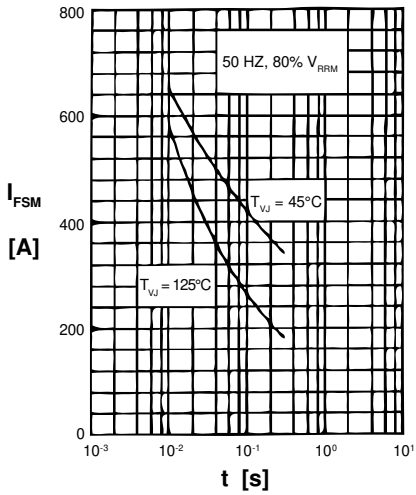

Fig. 1 Surge overload current  
 $I_{TSM}$ : Crest value,  $t$ : duration

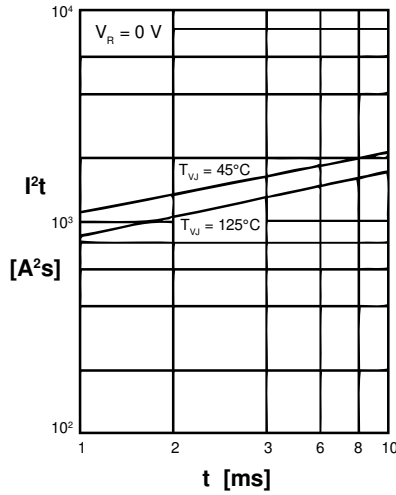

Fig. 2  $I^2t$  versus time (1-10 ms)

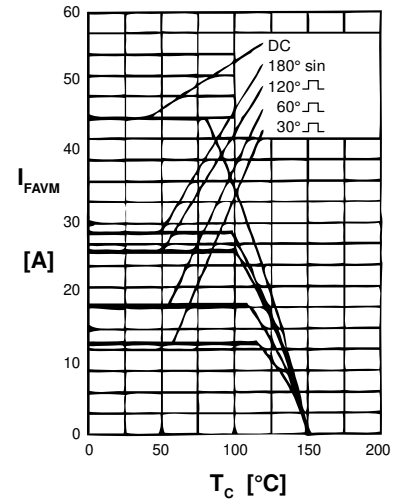

Fig. 3 Max. forward current at case temperature

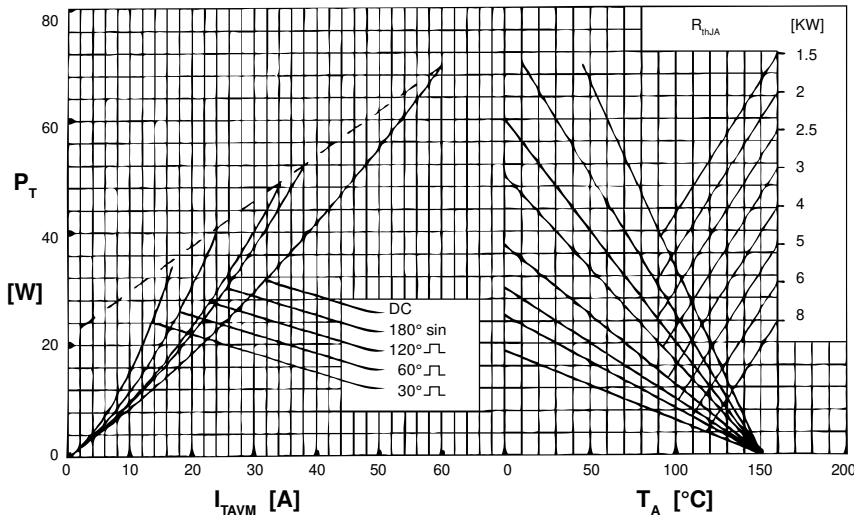

Fig. 4 Power dissipation versus onstate current & ambient temperature (per diode)

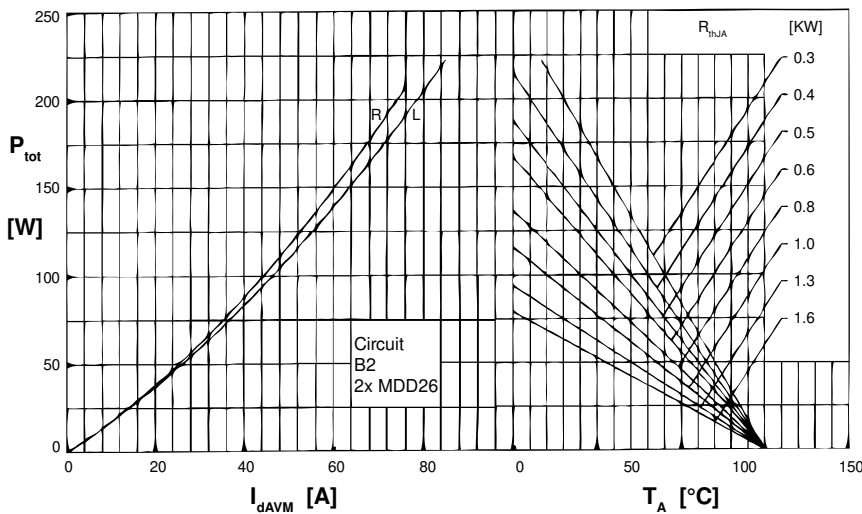

Fig. 6 Single phase rectifier bridge: Power dissipation vs. direct output current and ambient temperature; R = resistive load, L = inductive load



**Rectifier**

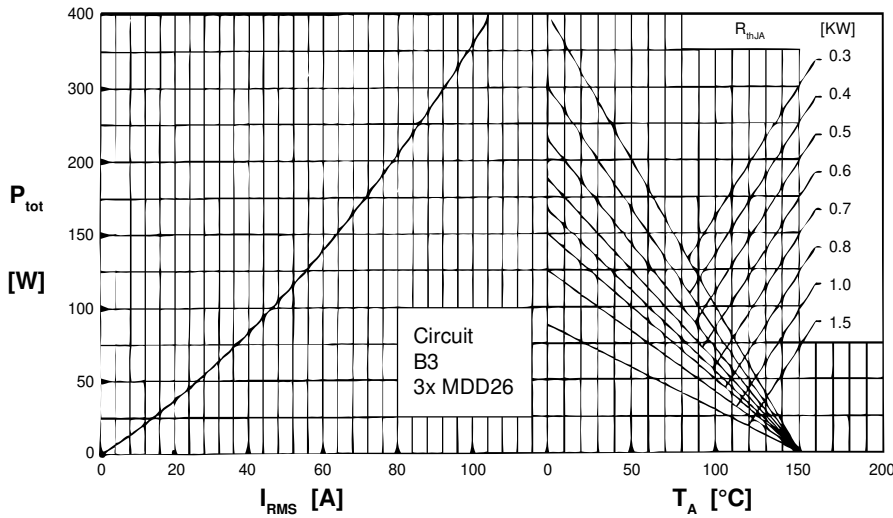

Fig. 6 Three phase rectifier bridge: Power dissipation versus direct output current and ambient temperature

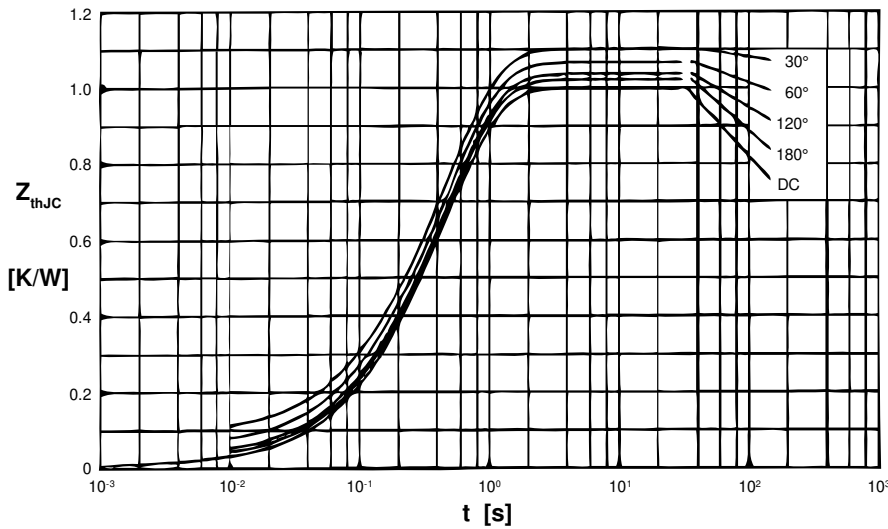

Fig. 7 Transient thermal impedance junction to case (per diode)

$R_{thJC}$  for various conduction angles d:

**d**  $R_{thJC}$  [K/W]

DC	1.00
180°	1.02
120°	1.04
60°	1.07
30°	1.10

Constants for  $Z_{thJC}$  calculation:

i	$R_{thi}$ [K/W]	$t_i$ [s]
1	0.01	0.0012
2	0.03	0.0950
3	0.96	0.4550

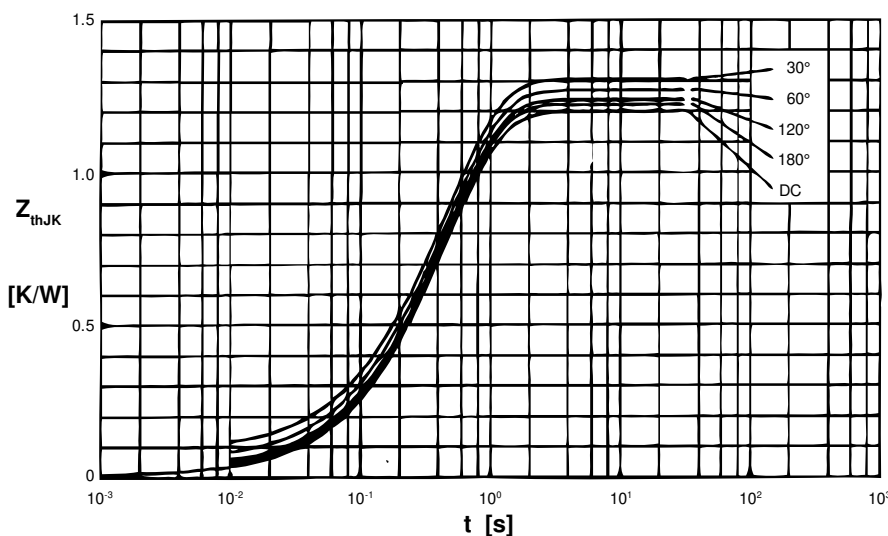

Fig. 8 Transient thermal impedance junction to heatsink (per thyristor)

$R_{thJK}$  for various conduction angles d:

**d**  $R_{thJK}$  [K/W]

DC	1.20
180°	1.22
120°	1.24
60°	1.27
30°	1.30

Constants for  $Z_{thJK}$  calculation:

i	$R_{thi}$ [K/W]	$t_i$ [s]
1	0.01	0.0012
2	0.03	0.0950
3	0.96	0.4550
4	0.20	0.4950