

2.5MHz 1.5A High Efficiency Low I_q Synchronous Boost

Features

- Wide Input Voltage Range: 2.7V to 5.5V
- Output Voltage 5.0V
- I_{OUT} up to 1.5 A at V_{OUT} = 5.0 V, V_{IN} ≥ 3 V
- 2.5MHz PWM Switching Frequency
- High Efficiency and Low Quiescent Current
 - ▶ Over 95% Efficiency
 - ▶ 1μA Shutdown Current
 - ▶ 33μA Quiescent Current in Pass Through
 - ▶ 56μA Quiescent Current in PFM Operation
- ±2% DC Voltage Accuracy in PWM mode
- Undervoltage Lockout (UVLO)
- Short Circuit Protection
- Hiccup Current Limit
- Over Temperature Protection
- Selectable Pass Through Mode or True Load Disconnect During Shutdown
- Output Capacitor Pre-Charge and Soft-Start
- Pb-free 9-Bump, WLCSP 1.260mm x 1.290mm
- RoHS and Green Compliant
- -40°C to 85°C Operating Temperature Range

Brief Description

The KTC2115 features a high-efficiency, micropower synchronous boost for Lithium-Ion/Polymer battery applications. It offers true output disconnect to achieve a shutdown quiescent current of less than 1.0μA, extending battery life.

High efficiency over a wide output current range is achieved by selecting PWM/PFM mode automatically depending on the output load conditions.

A Pass Through mode allows to transfer the input power directly to output (not boosting) with over current protection.

The constant on-time design does not require any external compensation components, simplifying the design and providing ultra-fast transient response.

The inrush current-limiting feature minimizes the voltage droop on the battery supply when the device is turned on.

The KTC2115 is packaged in advanced, RoHS and Green compliant, 1.260mm x 1.290mm, 9-balls Wafer-Level Chip-Scale Package (WLCSP).

Applications

- Smartphones and Tablets
- Mobile Internet Devices
- USB OTG
- Wearables
- Portable Devices

Typical Application

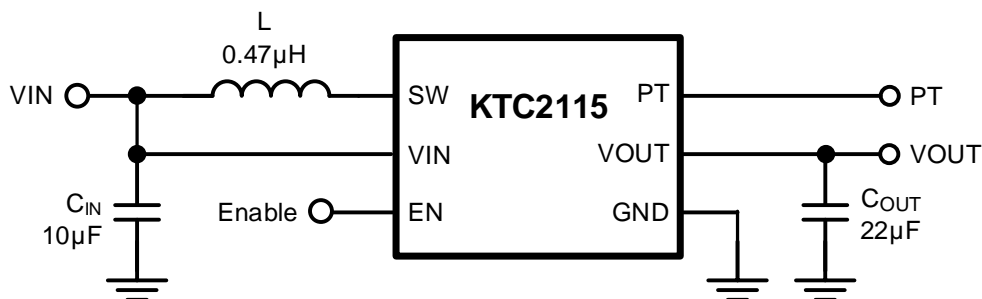

Pin Descriptions

Pin #	Name	Function
A1, A2	OUT	Boost converter output
A3	IN	Power supply input
B1, B2	SW	Boost switching node, connect to inductor
B3	EN	Active HIGH enable
C1, C2	GND	Ground
C3	PT	Active HIGH enable pass through mode

WLCSP-9

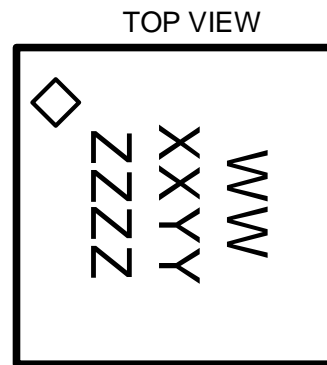
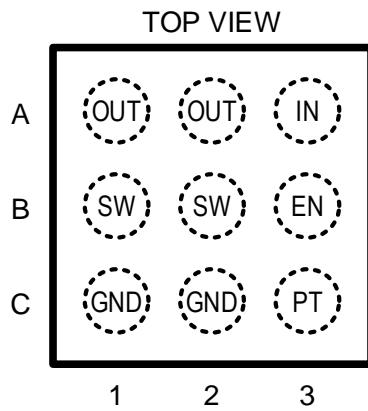

Top View

9-Bump 1.260mm x 1.290mm x 0.620mm
WLCSP Package

Top Mark

WW = Device ID Code
XX = Date Code, YY = Assembly Code
ZZZZ = Serial Number

Absolute Maximum Ratings¹

(T_A = 25°C unless otherwise noted)

Symbol	Description	Value	Units
IN	Voltage on IN pin	-0.3 to 6.3	V
OUT	OUT to GND	-0.3 to 6.3	V
SW	SW to GND DC	-0.3 to 7	V
EN	EN to GND	-0.3 to 6	V
PT	PT to GND	-0.3 to 6	V
Input Current	Continuous average current into SW	3.8	A
	Peak current into SW	4.5	A
T _J	Junction Operating Temperature Range	-40 to 150	°C
T _S	Storage Temperature Range	-65 to 150	°C
T _{LEAD}	Maximum Soldering Temperature (at leads, 10 sec)	260	°C

ESD and Latch-Up Ratings

Symbol	Description	Value	Units
V _{ESD_HBM}	Human-body model (HBM), per ANSI/ESDA/JEDEC JS-001-2017	±2000	V
V _{ESD_CD}	Charged Device Model (CDM), per ANSI/ESDA/JEDEC JS-002-2018	±1000	V
I _{LU}	Latch-Up, per JEDEC STANDARD JESD78E	±200	mA

Thermal Capabilities²

Symbol	Description	Value	Units
Θ _{JA}	Thermal Resistance – Junction to Ambient	72	°C/W
P _D	Maximum Power Dissipation at 25°C	1.74	W
ΔP _D /ΔT	Derating Factor Above T _A = 25°C	-13.9	mW/°C

Ordering Information

Part Number	V _{OUT}	Marking ³	Operating Temperature	Package
KTC2115ECAB-TA	5.0V	RNXXYYZZZZ	-40°C to +85°C	WLCSP33-9

- Stresses above those listed in Absolute Maximum Ratings may cause permanent damage to the device. Functional operation at conditions other than the operating conditions specified is not implied. Only one Absolute Maximum rating should be applied at any one time.
- Junction to Ambient thermal resistance is highly dependent on PCB layout. Values are based on thermal properties of the device when soldered to an EV board.
- XX = Date Code, YY = Assembly Code, ZZZZ = Serial Number.

Electrical Characteristics⁴

Unless otherwise noted, the *Min* and *Max* specs are applied over the full operation temperature range of -40°C to +85°C, $V_{IN} = 2.7V$ to $5.5V$. Typical values are specified at room temperature (25°C) with $V_{IN} = 3.6V$, $V_{OUT} = 5V$, $EN = HIGH$, $C_{OUT} = 22\mu F$, $L = 0.47\mu H$ and $T_A = 25^\circ C$.

Symbol	Description	Conditions	Min	Typ	Max	Units
Supply Specifications						
V_{IN}	Input Voltage Range		2.7		5.5	V
V_{UVLO}	UVLO Threshold	V_{IN} Rising	2.25	2.4	2.55	V
		V_{IN} Falling		2.3		V
V_{OVLO}	OVLO Threshold	V_{IN} Rising	5.5	5.8	6.2	V
		V_{IN} Falling		5.6		V
I_Q	Input Quiescent Current	No Load, $V_{EN} = High$		56	80	μA
I_{PT}	Input PT Quiescent Current	Pass Through, $V_{EN} = Low$, $V_{PT} = High$		33	70	μA
I_{SHDN}	Input Shutdown Current	$V_{EN} = 0V$; $V_{IN} = 5.5V$		1	5	μA
Enable Control (EN)						
V_{TH-H}	EN pin logic high voltage		1.2			V
V_{TH-L}	EN pin logic low voltage				0.4	V
I_{EN}	Enable Low Leakage Current	$V_{EN} = 0V$		0.01	0.1	μA
	Enable High Leakage Current	$V_{EN} = 1.8V$, $R_{pd} = 1M\Omega$ internally		2	3	μA
Pass Through Control (PT)						
V_{PTTH-H}	PT pin logic high voltage	V_{PT} Rising, Pass Through Enabled	1.2			V
V_{PTTH-L}	PT pin logic low voltage	V_{PT} Falling, Pass Through Off			0.4	V
I_{PT}	PT Low Leakage Current	$V_{PT} = 0V$		0.01	0.1	μA
	PT High Leakage Current	$V_{PT} = 1.8V$, $R_{pd} = 1M\Omega$ internally		2	3	μA
Timing						
T_S	Soft-Start	EN H to Regulation, $R_L = Open$, $V_{OUT} = 5.0V$		300		μs
T_{RES}	Fault Restart Timer			21		ms
Boost						
ΔV_{OUT}	Output Voltage Accuracy	$V_{IN} = 2.7V$ to $4.5V$, $V_{OUT} = 5.0V$, PWM operation	-2		2	%
ΔV_{OUT_LOAD}	Output Voltage Load Regulation	$V_{IN} = 3.6V$, $V_{OUT} = 5.0V$, $I_{OUT} = 50mA$ to $1500mA$		0.5		%
I_{VIN}	V_{IN} to V_{OUT} Leakage Current	$V_{OUT} = 0V$, $EN = PT = 0V$, $V_{IN} = 4.2V$,			1	μA
I_{VOUT}	V_{OUT} Reverse Leakage Current	$V_{OUT} = 5V$, $V_{IN} = 2.5V$, $EN = PT = 0V$			3.5	μA
$R_{DS(ON)P}$	High-Side P-Ch On-Resistance	$I_{SW} = 0.5A$, $V_{IN} = 5.0V$		90		m Ω
$R_{DS(ON)N}$	Low-Side N-Ch On-Resistance	$I_{SW} = -0.5A$, $V_{IN} = 5.0V$		60		m Ω
I_{SW_IN}	Leakage Current into SW	$V_{IN} = 5V$, $V_{SW} = 5V$, $V_{EN} = 0V$		0.1	2	μA
I_{SW_OUT}	Leakage Current out of SW	$V_{IN} = 5V$, $V_{SW} = 0V$, $V_{EN} = 0V$		0.1	2	μA
f_{OSC}	Frequency	$V_{IN} = 3.6V$, $V_o = 5.0V$, $I_o = 1A$		2.5		MHz
T_{ON}	Minimum On-Time			50		ns

4. KTC2115 is guaranteed to meet performance specifications over the -40°C to +85°C operating temperature range by design, characterization and correlation with statistical process controls.

Electrical Characteristics⁴

Unless otherwise noted, the *Min* and *Max* specs are applied over the full operation temperature range of -40°C to +85°C, $V_{IN} = 2.7V$ to $5.5V$. Typical values are specified at room temperature (25°C) with $V_{IN} = 3.6V$, $V_{OUT} = 5V$, $EN = HIGH$, $C_{OUT} = 22\mu F$, $L = 0.47\mu H$ and $T_A = 25^\circ C$.

Symbol	Description	Conditions	Min	Typ	Max	Units
T_{OFF}	Minimum OFF Time			90		ns
I_{LIM}	Switch Valley Current Limit			3.3		A
I_{PRE}	Pre-charge Current Limit (Linear Mode)			1.6		A
IC Thermal Protection						
T_{J_TH}	Thermal Shutdown	T_J Rising		150		°C
	Thermal Hysteresis	T_J Falling		20		°C

Typical Characteristics - DC

$V_{IN} = 3.6V$, $V_{OUT} = 5.0V$, $EN = High$, $PT = Low$, $C_{OUT} = 22\mu F$, $L = 0.47\mu H$ and $T_A = 25^\circ C$ unless otherwise specified.

Efficiency vs. Output Current

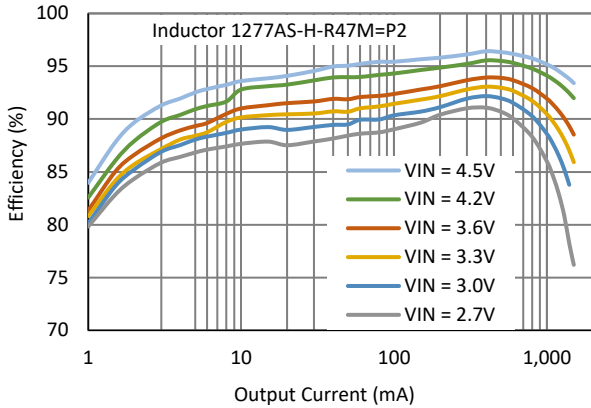

Switching Frequency vs. Output Current

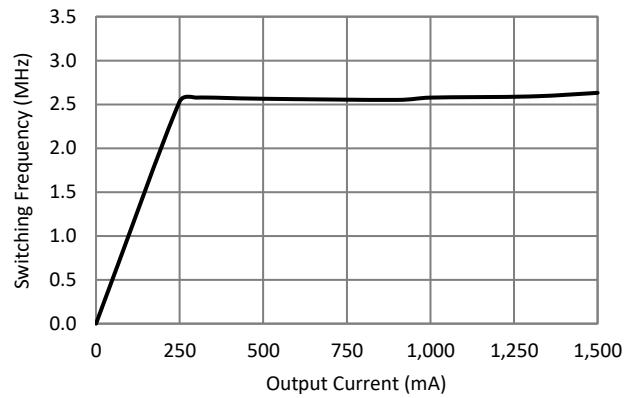

Output Voltage Accuracy vs Output Current

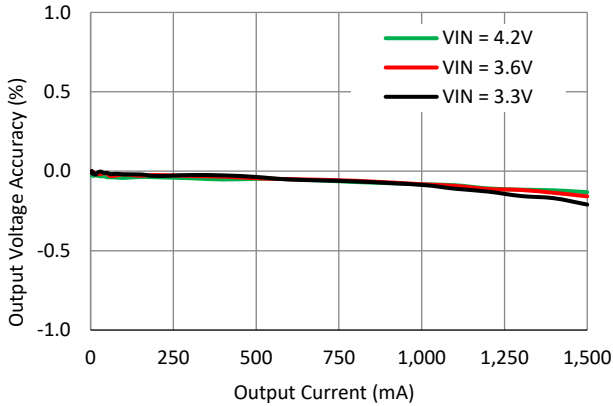

Boost Max Output Current vs VIN

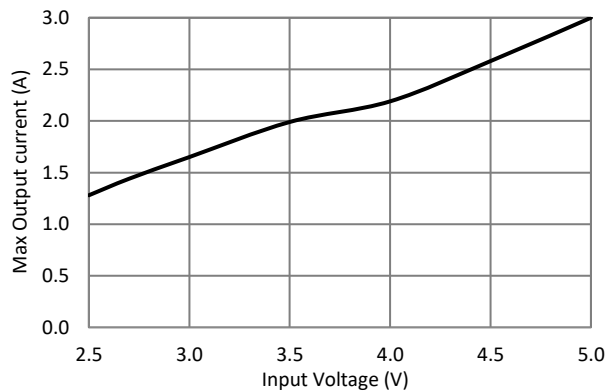

Boost Quiescent Current vs VIN (no load)

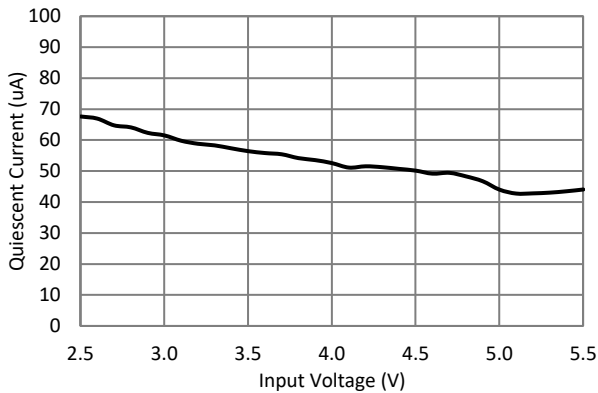

Bypass Mode Quiescent Current vs VIN (no load, EN = Low, PT = High)

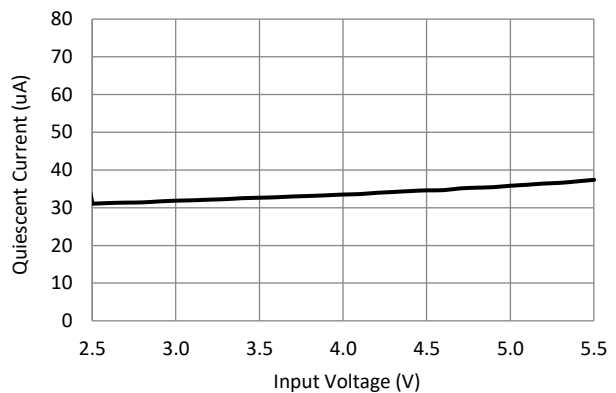

Typical Characteristics - DC

$V_{IN} = 3.6V$, $V_{OUT} = 5.0V$, $EN = High$, $PT = Low$, $C_{OUT} = 22\mu F$, $L = 0.47\mu H$ and $T_A = 25^\circ C$ unless otherwise specified.

Output Ripple Voltage vs. Output Current

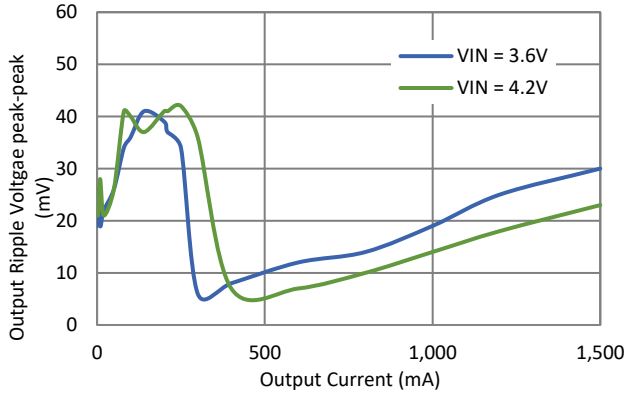

Typical Characteristics - AC

$V_{IN} = 3.6V$, $V_{OUT} = 5.0V$, EN = High, PT = Low, $C_{OUT} = 22\mu F$, $L = 0.47\mu H$ and $T_A = 25^\circ C$ unless otherwise specified.

Turn-on in Boost Mode
with 10mA load (500Ω)

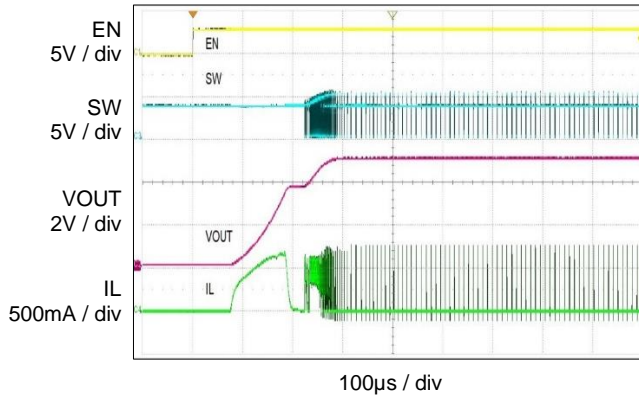

Transition between Boost and Pass mode
(PT= High) with 0.5A load (10Ω)

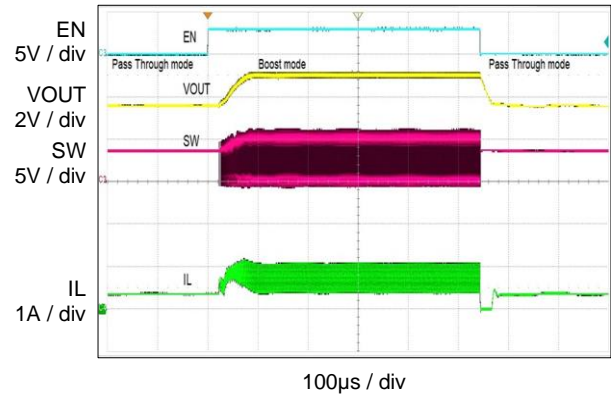

Switching waveform 50mA load (PFM mode)

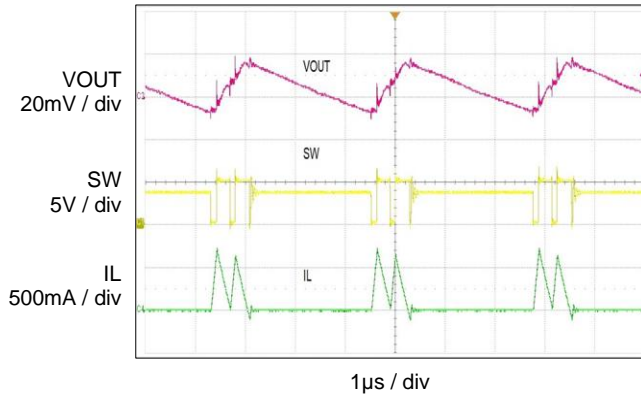

Switching waveform 350mA load (PWM mode)

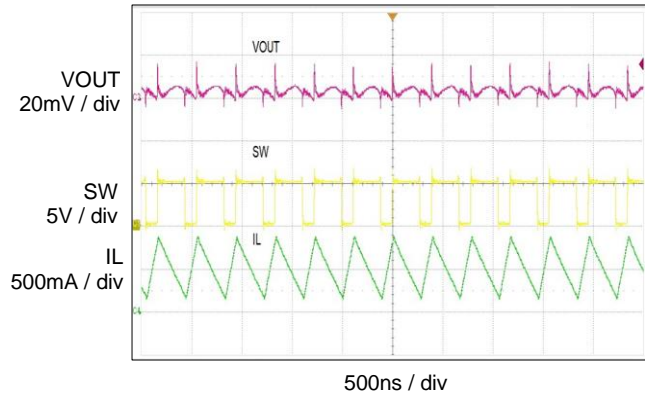

Load Step Response from 50mA to 500mA
(PFM to PWM)

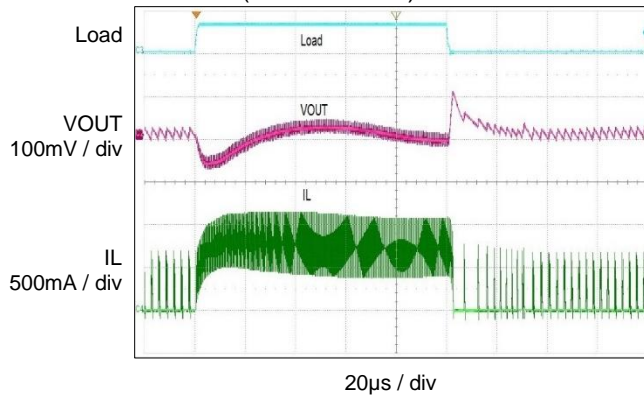

Line Transient VIN 3.3V to 3.9V
(500mA load)

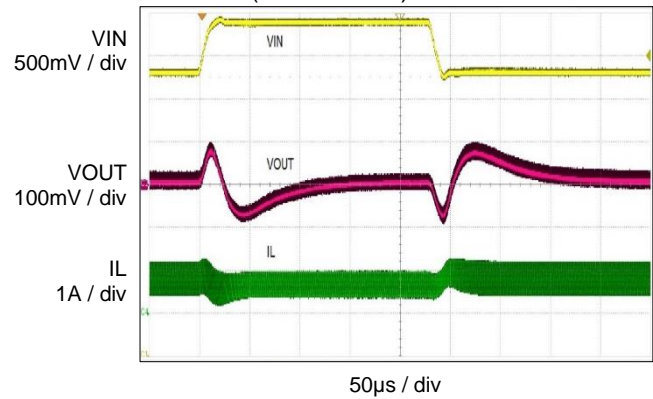

Typical Characteristics - AC

$V_{IN} = 3.6V$, $V_{OUT} = 5.0V$, EN = High, PT = Low, $C_{OUT} = 22\mu F$, $L = 0.47\mu H$ and $T_A = 25^\circ C$ unless otherwise specified.

Load step from 1A to 3A (Current limiting)

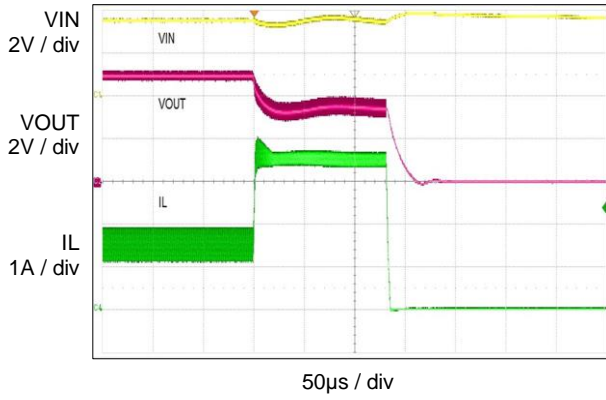

Current limiting with Hiccup (1A to 3A load)

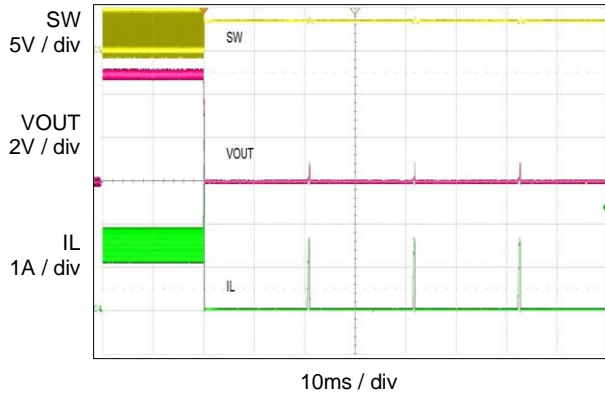

Functional Block Diagram

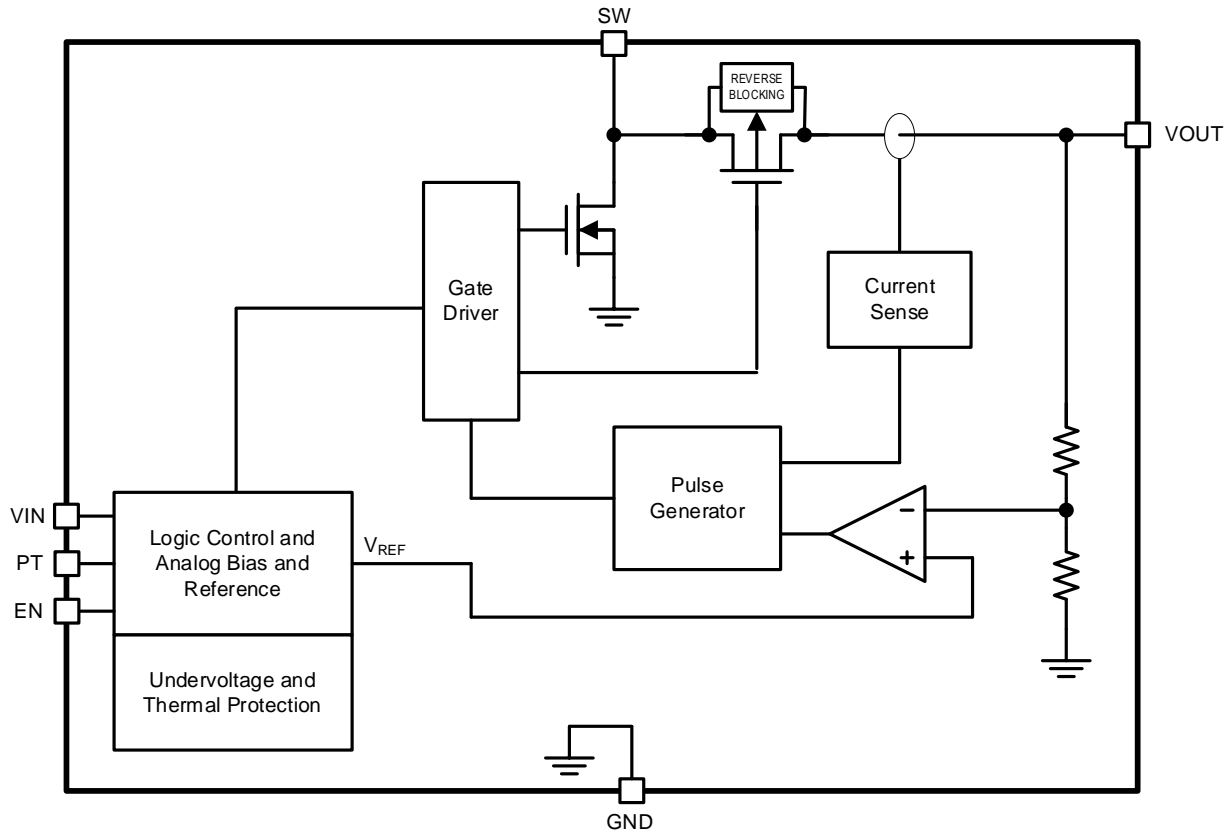

Functional Description

Overview

The KTC2115 is 2.5MHz synchronous boost converter with an additional Pass Through mode. In Boost mode, KTC2115 operates automatically either in PFM to achieve the best efficiency under light load, or in PWM for best line and load regulation under heavy load. KTC2115 enters Pass Through mode by pulling the PT pin high during shutdown state. In Pass Through mode, V_{OUT} is connected to V_{IN} supply via the inductor and the SW pin through the high-side MOSFET.

For the best load transient performance, KTC2115 uses a constant on-time control. At the beginning of each switching cycle, the low-side switch is turned on for an adaptive on-time to ramp-up the inductor current. At the end of the on-time, the high-side switch is turned-on and the inductor current decreases to a value determined by the compensation voltage. The switching cycle repeats by triggering the on timer again and turning on the low-side switch.

Enable

When the EN input goes high, KTC2115 starts-up in soft-start phase. When EN goes low while PT pin is low, KTC2115 goes into true shutdown mode with V_{OUT} disconnected from V_{IN} . Setting the EN pin low and the PT pin high forces KTC2115 into Pass Through Mode.

Boost Mode: Startup

The KTC2115 internal soft start circuit limits the inrush current during startup. The start-up first phase is Pre-charge, where the circuit takes about 200µs to ramp up the output voltage while the charging current increases within the 1.6A current limit. If after 200µs, the output voltage V_{OUT} is higher than 1V, the device keeps charging the output, otherwise a fault is declared. If the output voltage V_{OUT} reaches V_{IN}-0.35V within a 1ms charging time limit, the device enters the Soft-start phase, otherwise a fault is declared.

After successfully completing the Pre-charge phase, the next phase is Soft-start where the boost regulator starts switching. During the Soft-start, the output voltage ramps-up smoothly limiting the inrush current until the nominal output voltage is reached. If the output V_{OUT} fails to reach regulation during Soft-start for more than 128µs, a fault is triggered. For larger output capacitor C_{OUT}, the output voltage ramp-up speed is slower to avoid excessive input current. During Soft-start phase, if V_{OUT} < V_{IN} - 0.35V and overcurrent is triggered, a fault will also be declared.

Boost Mode: Normal Operation

In Boost mode, once the startup is successfully finished, KTC2115 enters normal operation. In Boost mode, KTC2115 can operate in Auto-Bypass once V_{IN} > V_{OUT_NOM} (5V default) and no switching is detected for 5µs, the control scheme keeps V_{OUT} following V_{IN}. As soon as V_{IN} falls below 0.98*V_{OUT_NOM}, it resumes normal boost operation. KTC2115 can smoothly switch between auto-bypass state and boost state to keep V_{OUT} within regulation targets. In Auto-Bypass state, if the condition V_{OUT} < V_{IN} - 0.35V occurs, a fault is declared. In boost state, the switch valley current limit is increased to 3.3A. If the current limit happens for longer than 150µs, a fault is declared.

The KTC2115 features a valley current limit sensing scheme. Current limit control happens during the off-time by sensing the voltage drop across the high-side FET. The output voltage will be reduced when current limit happens, because the power stage operates in a limited current mode. The maximum continuous output current I_{OUT_MAX} can be defined by below formula.

$$(1) I_{OUT_MAX} = (1 - D) \bullet (I_{L_VALLEY} + \frac{\Delta I_L}{2})$$

When the load current increases causing inductor valley current larger than the current limit threshold, the off-time is extended automatically to allow the inductor current to decrease to the valley current limit threshold before starting the next on-time cycle.

Pass Through Mode: Startup

For startup under Pass Through mode (EN = low, PT = high), once startup successfully finished, KTC2115 enters Normal Operation. KTC2115 only has Pre-charge Phase. During Pre-charge, it takes 200µs to ramp up the pre-charge current from 0A to its final value 1.6A. After 200µs of 1.6A charging, if V_{OUT} is higher than 1V, device will keep charging the output otherwise a fault will be declared. After 1ms of 1.6A charging, if V_{OUT} is within V_{IN}-0.35V, it will come to Normal Operation, otherwise a fault will be declared.

Pass Through Mode: Normal Operation

In Pass Through Mode (EN = 0, PT = 1), once Startup is successfully completed, KTC2115 enters normal operation where the high-side MOSFET is fully turned on. KTC2115 keeps the output voltage following the input voltage with only 35µA (typ) quiescent current. In this mode, if the condition V_{OUT} < V_{IN} - 0.35V is detected, a fault is declared.

Table 1. Operating Mode Control

OPERATING MODE	EN	PT
Shutdown, True Load Disconnect (SD)	0	0
Standby Pass Through Mode, Output Pre-Biased (SPTM)	0	1
Boost Operating Mode (BST)	1	x

Fault State:

KTC2115 enters Fault state under any of the following conditions:

1. V_{OUT} fails to achieve the voltage required during Boost Mode/Pass Through Mode Pre-Charge Phase.
2. V_{OUT} fails to reach regulation for 128 μ s during Boost Mode Soft start Phase.
3. $V_{OUT} < V_{IN} - 0.35V$ and overcurrent is triggered during Boost Mode Soft start Phase.
4. Boost current limit exceeded for 150 μ s during Boost Mode Normal Operation.
5. $V_{OUT} < V_{IN} - 0.35V$ during Pass Through Mode Normal Operation or Boost Mode Auto-Bypass State and Boost State.
6. $V_{IN} < \text{Input UVLO}$

Once a fault is triggered, the regulator stops switching and disconnects the path between V_{IN} and V_{OUT} . After 21ms hiccup period, it will automatically try to restart.

Thermal Shutdown

As soon as the junction temperature T_j is higher than 150°C (typ.), the device enters thermal shutdown mode where the power stage is turned-off. When T_j falls below 130°C (typ.), the device turns back on.

Application Information

Recommended PCB Layout

KTC2115 is a high frequency switching regulator. Therefore the traces must be kept as short as possible between the inductor and the device SW pin. The input bypass capacitor C_{IN} should be located as close as possible to the inductor and to the device in order to minimize the ripple voltage and improve the stability. The output capacitor C_{OUT} must be located as close as possible to the IC in order to minimize the output ripple and improve the stability. It is recommended to connect both capacitors GND pads directly to the GND plane with a direct path to the device GND pins. Good layout practices should be used to avoid excessive noise spikes on SW pin which could cause voltages above Absolute Maximum Rating.

In order to support heavy load current and maximize the efficiency, it is important to keep traces wide on V_{IN}, V_{OUT} and on both sides of the inductor.

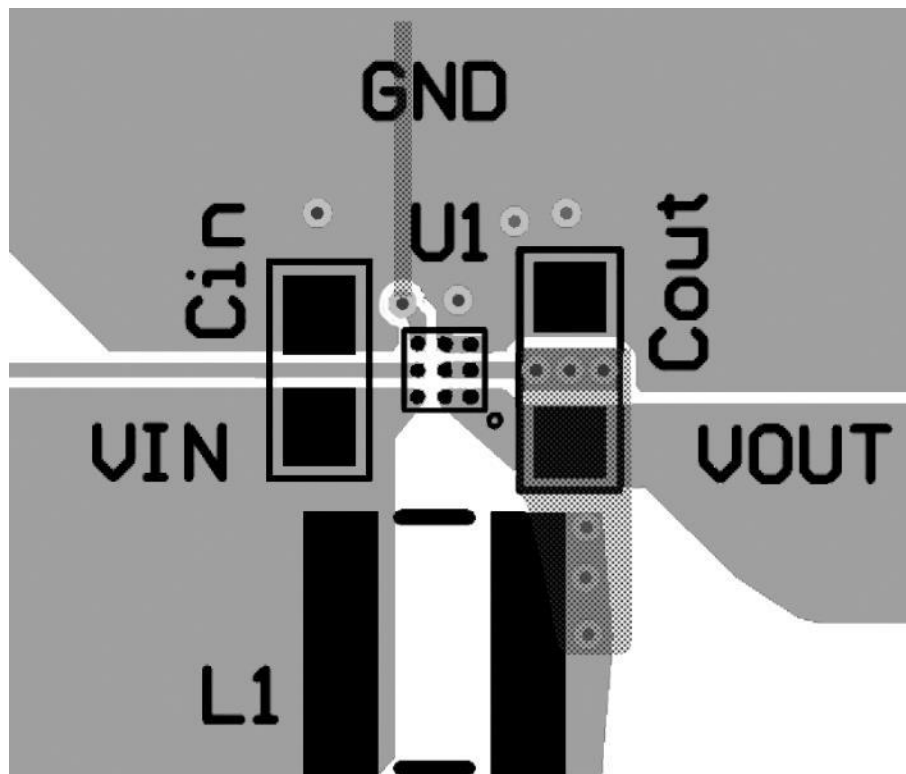
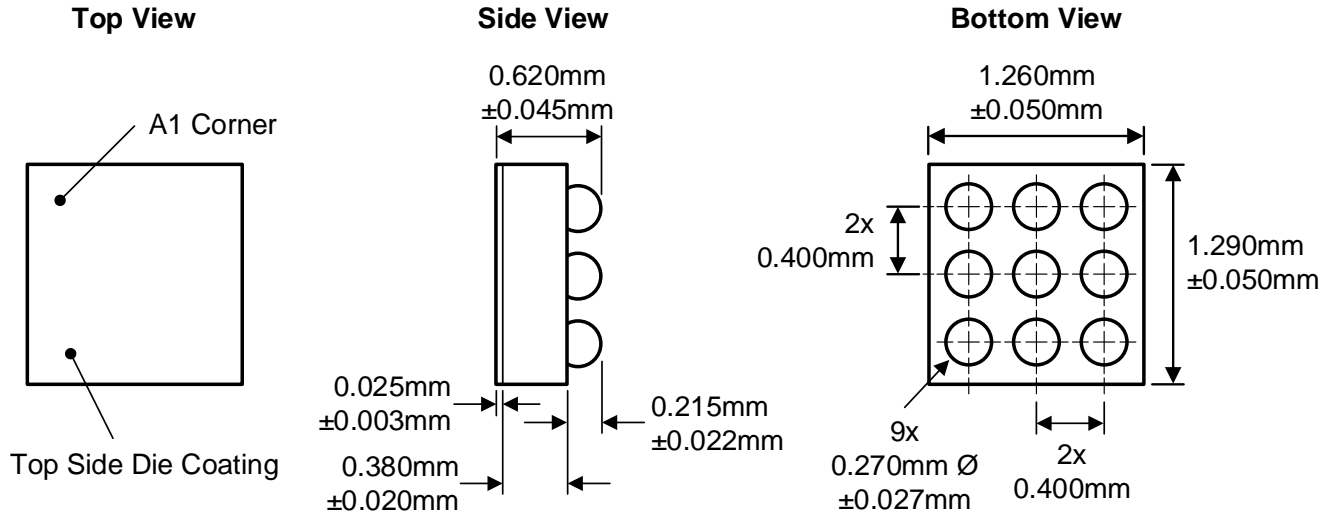

Figure 1. Recommended PCB Layout

Packaging Information

WLCSP33-9 (1.260mm x 1.290mm x 0.620mm)



Recommended Footprint

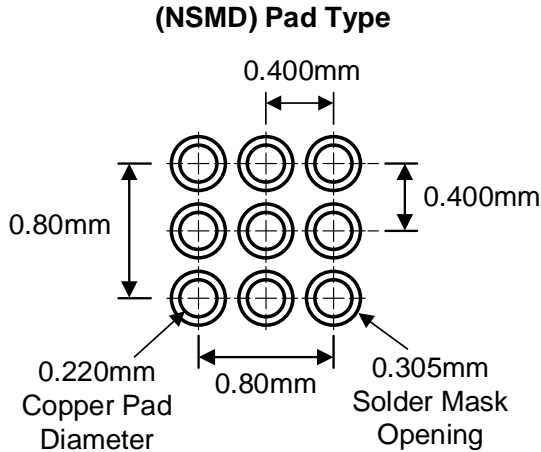

Kinetic Technologies cannot assume responsibility for use of any circuitry other than circuitry entirely embodied in a Kinetic Technologies product. No intellectual property or circuit patent licenses are implied. Kinetic Technologies reserves the right to change the circuitry and specifications without notice at any time

Mouser Electronics

Authorized Distributor

Click to View Pricing, Inventory, Delivery & Lifecycle Information:

[Kinetic Technologies:](#)

[KTC2115ECAB-TA](#)