

Features

Regulated Converter

- 160W baseplate-cooled, fan-less operation
- 230W peak power or forced air rating
- Universal AC input range (80~264VAC)
- Standby power consumption <0.5W
- Wide operating temperature range (-40°C to +80°C)
- Household, ITE and medically 2MOPP certified
- Operating altitude up to 5000m



RACM230-G

230 Watt

4" x 2"

Open Frame or Enclosed Single Output



Description

The RACM230-G Series is designed to support up to 160 watts continuous output power without fan cooling. The compact 4"x2" baseplate design enables direct heat dissipation through metal housings in the application. Up to 230 watts are available to drive dynamic loads for several seconds of peak power or with forced air for even longer time frames. A smart fan output is on board as standard. A wide input range of 80 to 264VAC, up to 5000m operating altitude, 4kVAC isolation and international safety agency certifications make the series worldwide compliant for medical 2 MOPP, household and industrial ITE applications.

Selection Guide

Part Number	Input Voltage Range [VAC]	Nom. Output Voltage [VDC]	Max. Output Current ⁽¹⁾ [A]	Efficiency typ. ⁽³⁾ [%]
RACM230-12SG ⁽⁴⁾	80-264	12	19.17 ⁽²⁾	91
RACM230-24SG ⁽⁴⁾	80-264	24	9.58	92
RACM230-36SG ⁽⁴⁾	80-264	36	6.39	92
RACM230-48SG ⁽⁴⁾	80-264	48	4.80	92
RACM230-54SG ⁽⁴⁾	80-264	54	4.26	92

Notes:

- Note1: With forced air cooling (2.5m/s) + conduction cooling + refer to "Derating Graph"
- Note2: Refer to "Peak Load Capability" graph
- Note3: Efficiency is tested at nominal input and full load at +25°C ambient



Model Numbering

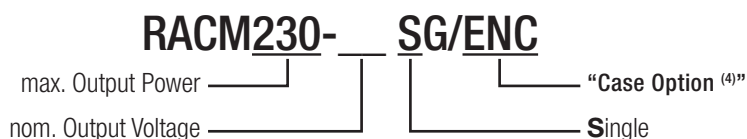

Notes:

- Note4: without suffix standard open frame version
add suffix "/ENC" for enclosed version (MOQ may apply for this model)

Ordering Examples:

RACM230-24SG	24Vout	Single	open frame
RACM230-48SG/ENC	24Vout	Single	enclosed



- ANSI/AAMI ES60601-1 (ed 3.1) ("OF" version)
- CSA/CAN 22.2 60601-1-14 (ed 3.1) certified
- IEC/EN60601-1 (ed 3.1) ("OF" version) certified
- IEC/EN62368-1 certified
- EN60335-1 certified
- EN62233 certified
- IEC/EN61558-1 certified
- IEC/EN61558-2-16 certified
- EN55032 compliant
- EN55035 compliant
- CB Report

Specifications (measured @ Ta= 25°C, 230VAC rated load unless otherwise stated)

BASIC CHARACTERISTICS

Parameter	Condition	Min.	Typ.	Max.
Nom. Input Voltage		100VAC		240VAC
Input Voltage Range ⁽⁵⁾		80VAC 120VDC	230VAC	264VAC 370VDC
Input Current	115VAC 230VAC			3A 1.1A
Inrush Current	115VAC 230VAC			40A 60A
No load Power Consumption			300mW	500mW
Input Frequency Range	AC input	47Hz	50Hz	63Hz
ErP Lot 6 Standby Mode Conformity (Output Load Capability)	Input Power= 1W			300mW
Output Voltage Adjustability ⁽⁶⁾	12Vout 24Vout 36Vout 48Vout 54Vout	11.4VDC 22.8VDC 34.2VDC 45.6VDC 51.3VDC		12.6VDC 25.2VDC 37.8VDC 50.4VDC 56.0VDC
Minimum Load		0%		
Power Factor	115VAC 230VAC	0.98 0.95	0.99 0.97	
Start-up Time	115/230VAC		0.5s	
Rise Time			10ms	
Hold-up Time	115/230VAC	230W 200W 160W 130W	8ms 10ms 16ms 25ms	
Output Ripple and Noise ⁽⁷⁾	20MHz BW @ +25°C			1% of Vout nom. max.

Notes:

- Note5: The products were submitted for safety files at nominal AC-input operation. For DC-input make sure that sufficient fuses are used
- Note6: By trimming up, decrease output current to avoid exceeding rated output power. By trimming down, do not exceed maximum continuous output current. If enclosed version is used, please remove cover, to use trim function.
- Note7: Measurements are made with a 12" twisted pair-wire terminated with a 0.1µF and 10µF parallel capacitor

Efficiency vs. Load

24V to 54V models

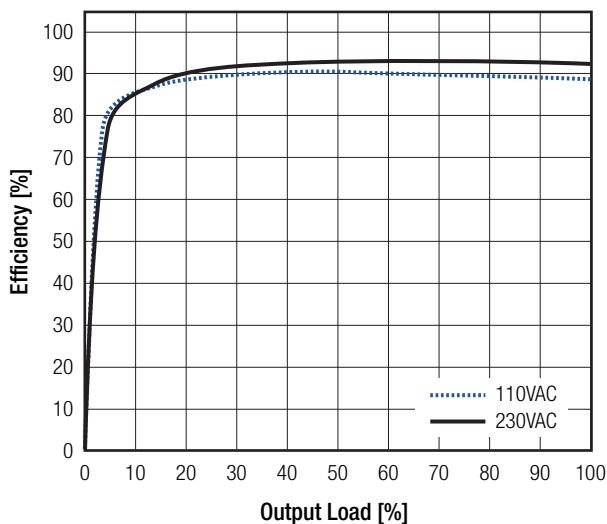

12V model

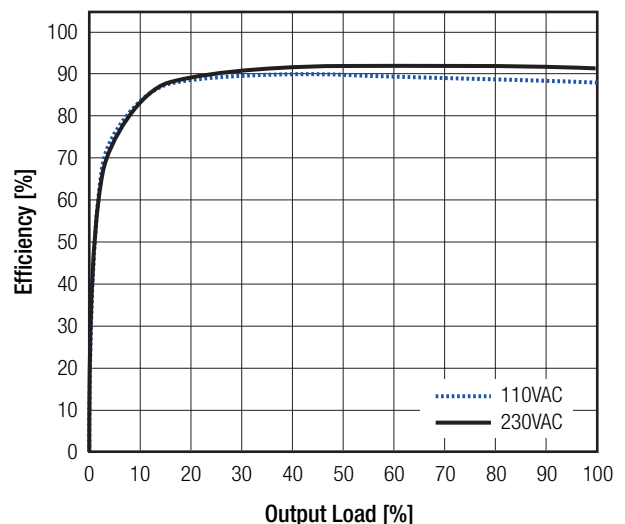

continued on next page

Specifications (measured @ Ta= 25°C, rated input, rated load unless otherwise stated)

REGULATIONS		
Parameter	Condition	Value
Output Accuracy		±1.0% typ.
Line Regulation	low line to high line, full load	±0.5% typ.
Load Regulation ⁽⁸⁾	10% to 100% load	0.5% typ.
Notes: Note8: Operation below 10% load will not harm the converter, but specifications may not be met		

FAN OUTPUT					
Parameter	Condition		Min.	Typ.	Max.
Output Current	@50°C	continuous			500mA
Output Voltage				12VDC	
Ambient Temperature	full load				50°C
Short Circuit Protection (SCP)					none
Over Current Protection (OCP)					none

PROTECTIONS		
Parameter	Type	Value
Internal Input Fuse ⁽⁹⁾	line and neutral	2x T6.3A, slow blow type
Short Circuit Protection (SCP)		hiccup mode, auto recovery
Over Voltage Protection (OVP)		105% - 150%, latch off mode
Over Load Protection (OLP)		105% - 200% (150% typ.); hiccup mode auto recovery
Over Voltage Category (OVC)		OVCII
Isolation Voltage (safety certified) ⁽¹⁰⁾	I/P to O/P	1 minute
Isolation Resistance		10MΩ min.
Insulation Grade		reinforced
Leakage Current		0.3mA max.
Means of Protection	250VAC working voltage	2MOPP
Notes: Note9: Refer to local safety regulations if input over-current protection is also required. Recommended fuse: slow blow type Note10: For repeat Hi-Pot testing, reduce the time and/or the test voltage		

ENVIRONMENTAL		
Parameter	Condition	Value
Operating Temperature Range	refer to derating graphs	-40°C to +80°C
Temperature Coefficient		±0.05%/K
Operating Altitude ⁽¹¹⁾		5000m
Operating Humidity	non-condensing	5% - 90% RH max.
Pollution Degree		PD2
MTBF	according to MIL-HDBK-217F, G.B.	+25°C (forced air cooling) +50°C (forced air cooling)
		200 x 10 ³ hours 60 x 10 ³ hours
Notes: Note11: Recognized by safety agency for safe operation up to 5000m. High altitude operation may impact the performance and lifetime. Please contact RECOM tech support for advice.		

continued on next page

Specifications (measured @ Ta= 25°C, rated input, rated load unless otherwise stated)

Derating Graph ⁽¹²⁾

(@ 2.5m/s airflow + conduction cooling)

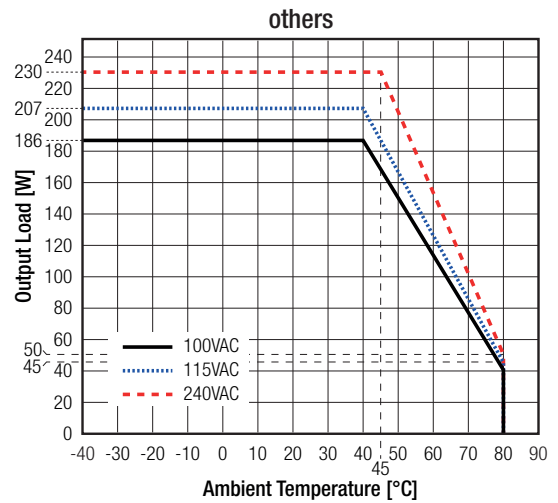
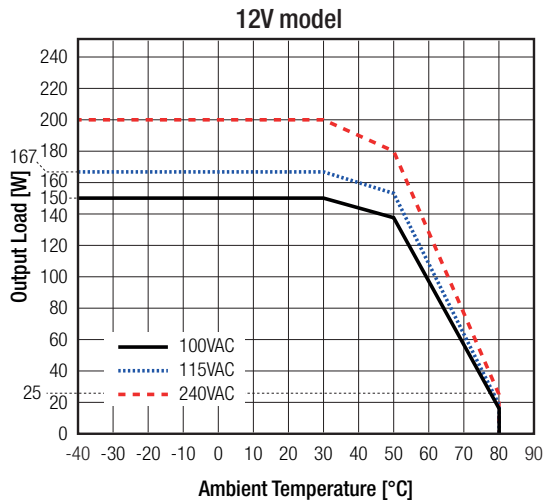

Derating Graph ⁽¹²⁾

(@ natural convection + conduction cooling)

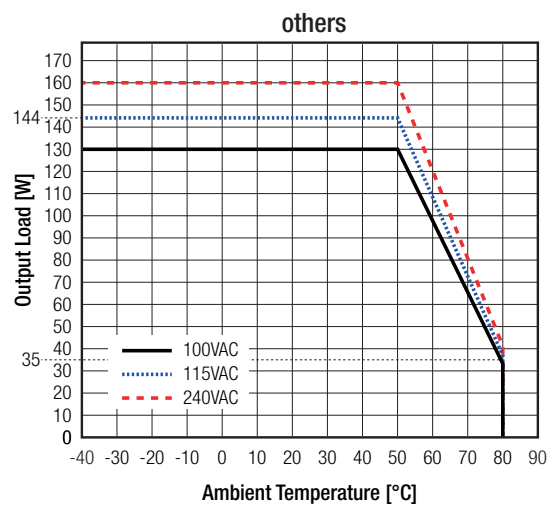
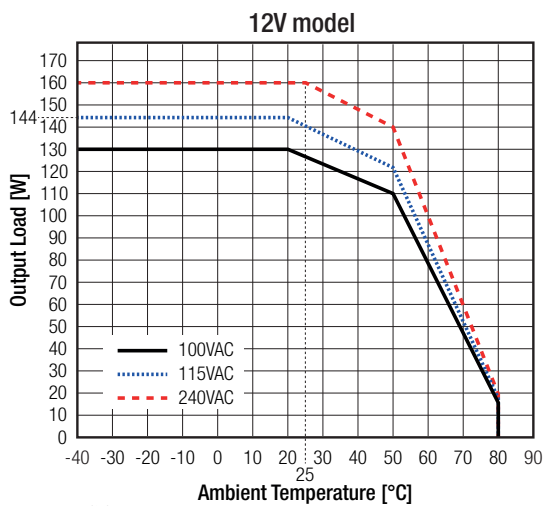

Derating Graph ⁽¹²⁾

(@ natural convection)

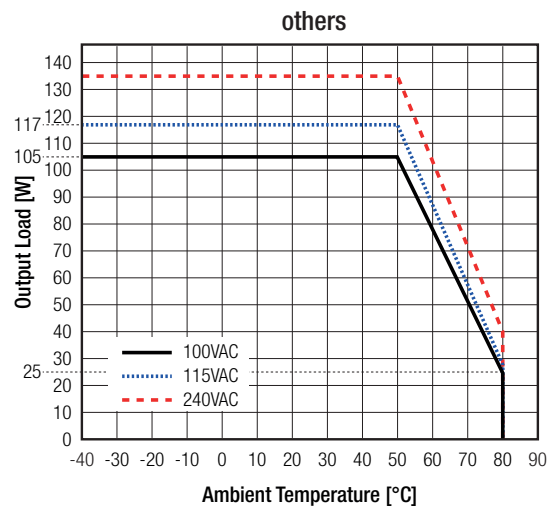
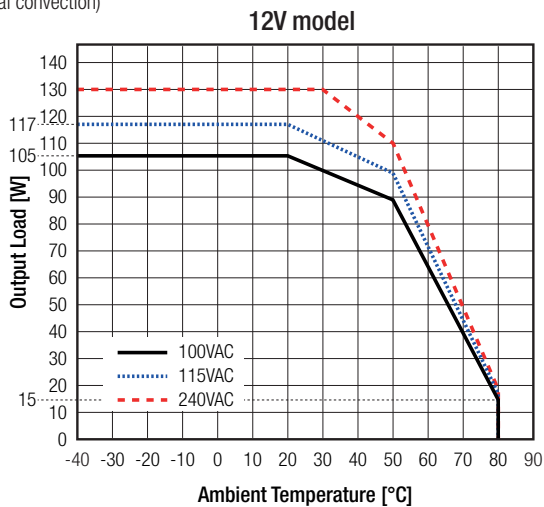

Convection Cooling:
<0.1m/s = still air
0.1 - 0.2m/s = natural convection

Conduction Cooling:
ground plane ref.: 2mm alloy; size A4

Notes:

Note12: For operation to as low as 80VAC a further derating of -10% is recommended

Specifications (measured @ Ta= 25°C, rated input, rated load unless otherwise stated)

Peak Load Capability

Calculation

- P_{nom} = nom. output power [W]
- P_p = peak output power (≤230W) [W]
- P_r = recovery output power [W]
- t₁ = peak time set (10s max.) [s]
- t₂ = recovery time (min. 4 x t₁) [s]
- k = safety factor 1.7 []

$$P_r = \frac{P_{nom} \times (t_1 + t_2) - (P_p \times t_1)}{t_2 \times k}$$

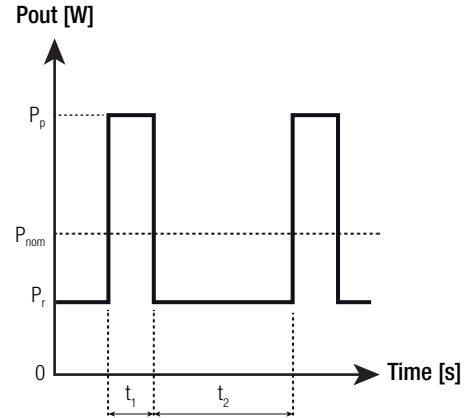

Practical Example (RACM230-12SG):

Take the RACM230-12SG at 230VAC input Voltage and full load at T_{AMB} = 25°C (160W) with conduction cooling.

P_{nom.} = refer to derating graphs (160W)

P_p = 230W

t₁ = 1s

t₂ = 40s

k = 1.7

$$P_r = \frac{160 \times (1 + 40) - (230 \times 1)}{40 \times 1.7} = \underline{\underline{93W}}$$

SAFETY AND CERTIFICATIONS

Certificate Type (Safety)	Report Number	Standard
Audio/video, information and communication technology equipment - Safety requirements	SA1903063L01001	IEC62368-1:2014 2nd Edition
Audio/video, information and communication technology equipment - Safety requirements (LVD)		EN62368-1:2014 + A11:2017
Audio/video, information and communication technology equipment - Safety requirements (CB)	211-700882-000	IEC62368-1:2014, 2nd Edition
Audio/video, information and communication technology equipment - Safety requirements	SA1903063L01001	EN62368-1:2014 + A11:2017
Household and similar electrical appliances - Safety - Part 1: General requirements		EN60335-1:2012 + A13:2017
Measurement methods for electromagnetic fields of household appliances and similar apparatus with regard to human exposure	SA0903063L02001	EN62233:2008
Medical Electric Equipment, General Requirements for Safety and Essential Performance	E314885 ("OF" Version)	ANSI/AAMI ES60601-1:2005 + A2:2010/ (R)2012 CAN/CSA-C22.2 No. 6060-1:14, 3rd Edition
Medical Electric Equipment, General Requirements for Safety and Essential Performance (CB)	E314885	IEC60601-1:2005, 3rd Edition + AM1:2012
Medical Electric Equipment, General Requirements for Safety and Essential Performance		EN60601-1:2006 + A1:2013
Safety of power transformers, power supplies, reactors and similar products - Part 1: General requirements and tests	211-700883-000	IEC61558-1:2005, 2nd Edition + A1:2009 EN61558-1:2005 + A1:2009
Safety of transformers, reactors, power supply units and similar products for supply voltages up to 1100 V - Part 2-16: Particular requirements and tests for switch mode power supply units and transformers for switch mode power supply units (CB)	211-700883-000	IEC61558-2-16:2009, 1st Edition + A1:2013
Safety of transformers, reactors, power supply units and similar products for supply voltages up to 1100 V - Part 2-16: Particular requirements and tests for switch mode power supply units and transformers for switch mode power supply units (LVD)	211-700883-000	EN61558-2-16:2009 + A1:2013
RoHS2		RoHS 2011/65/EU + AM2015/863

continued on next page

Specifications (measured @ Ta= 25°C, rated input, rated load unless otherwise stated)

SAFETY AND CERTIFICATIONS

Certificate Type (Safety)	Report Number	Standard
Audio/video, information and communication technology equipment - Safety requirements	SA1903063L01001	IEC62368-1:2014 2nd Edition
Audio/video, information and communication technology equipment - Safety requirements (LVD)		EN62368-1:2014 + A11:2017
Audio/video, information and communication technology equipment - Safety requirements (CB)	211-700882-000	IEC62368-1:2014, 2nd Edition
Audio/video, information and communication technology equipment - Safety requirements	SA1903063L01001	EN62368-1:2014 + A11:2017
Household and similar electrical appliances - Safety - Part 1: General requirements	SA0903063L02001	EN60335-1:2012 + A13:2017
Measurement methods for electromagnetic fields of household appliances and similar apparatus with regard to human exposure		EN62233:2008
Medical Electric Equipment, General Requirements for Safety and Essential Performance	E314885 ("OF" Version)	ANSI/AAMI ES60601-1:2005 + A2:2010/(R)2012 CAN/CSA-C22.2 No. 6060-1:14, 3rd Edition
Medical Electric Equipment, General Requirements for Safety and Essential Performance (CB)	E314885	IEC60601-1:2005, 3rd Edition + AM1:2012
Medical Electric Equipment, General Requirements for Safety and Essential Performance		EN60601-1:2006 + A1:2013
Safety of power transformers, power supplies, reactors and similar products - Part 1: General requirements and tests	211-700883-000	IEC61558-1:2005, 2nd Edition + A1:2009 EN61558-1:2005 + A1:2009
Safety of transformers, reactors, power supply units and similar products for supply voltages up to 1100 V - Part 2-16: Particular requirements and tests for switch mode power supply units and transformers for switch mode power supply units (CB)	211-700883-000	IEC61558-2-16:2009, 1st Edition + A1:2013
Safety of transformers, reactors, power supply units and similar products for supply voltages up to 1100 V - Part 2-16: Particular requirements and tests for switch mode power supply units and transformers for switch mode power supply units (LVD)	211-700883-000	EN61558-2-16:2009 + A1:2013
RoHS2		RoHS 2011/65/EU + AM2015/863

EMC Compliance	Condition	Standard / Criterion
Electromagnetic compatibility of multimedia equipment - Emission requirements	without external filter	EN55032:2015, Class B
Electromagnetic compatibility of multimedia equipment - Immunity requirements		EN55035:2017
Information technology equipment - Immunity characteristics - Limits and methods of measurement		EN55024:2010 + A1:2015
ESD Electrostatic discharge immunity test	Air: $\pm 8\text{kV}$; Contact $\pm 4\text{kV}$	IEC61000-4-2:2008, Criteria A EN61000-4-2:2009, Criteria A
Radiated, radio-frequency, electromagnetic field immunity test	3V/m (80-1000, 1800MHz, 2600MHz, 3500MHz, 5000MHz)	IEC/EN61000-4-3:2006+A2:2010, Criteria A
Fast Transient and Burst Immunity	AC Power Port: L, N $\pm 1\text{kV}$	IEC/EN61000-4-4:2012, Criteria A
Surge Immunity	AC Power Port: L-N $\pm 1\text{kV}$	IEC/EN61000-4-5:2014, Criteria B
Immunity to conducted disturbances, induced by radio-frequency fields	AC Power Port: 3V (0.15-10MHz) 3V to 1V (10-30MHz) 1V (30-80MHz)	IEC61000-4-6:2013, Criteria A EN61000-4-6:2014, Criteria A
Power Magnetic Field Immunity	50Hz/60Hz, 1A/m	IEC61000-4-8:2009, Criteria A EN61000-4-8:2010, Criteria A
Voltage Dips and Interruptions	Voltage Dips 100% at 50/60Hz	IEC/EN61000-4-11:2004, Criteria A
	Voltage Dips 30% at 50Hz	IEC/EN61000-4-11:2004, Criteria A
	Voltage Dips 30% at 60Hz	IEC/EN61000-4-11:2004, Criteria B
	Voltage Interruptions > 95% at 50Hz	IEC/EN61000-4-11:2004, Criteria C
	Voltage Interruptions > 95% at 60Hz	IEC/EN61000-4-11:2004, Criteria B
Limits of Harmonic Current Emissions		EN61000-3-2:2014
Limits of Voltage Fluctuations & Flicker		EN61000-3-3:2013

Specifications (measured @ Ta= 25°C, rated input, rated load unless otherwise stated)

DIMENSION AND PHYSICAL CHARACTERISTICS

Parameter	Type	Value
Material	PCB baseplate / case ("ENC")	FR4, (UL94 V-0) aluminum
Dimension (LxWxH)	open frame version enclosed version	101.6 x 50.8 x 32.0mm 105.0 x 62.0 x 35.0mm
Weight	open frame version enclosed version	220g typ. 290g typ.

Dimension Drawing Open Frame (mm)

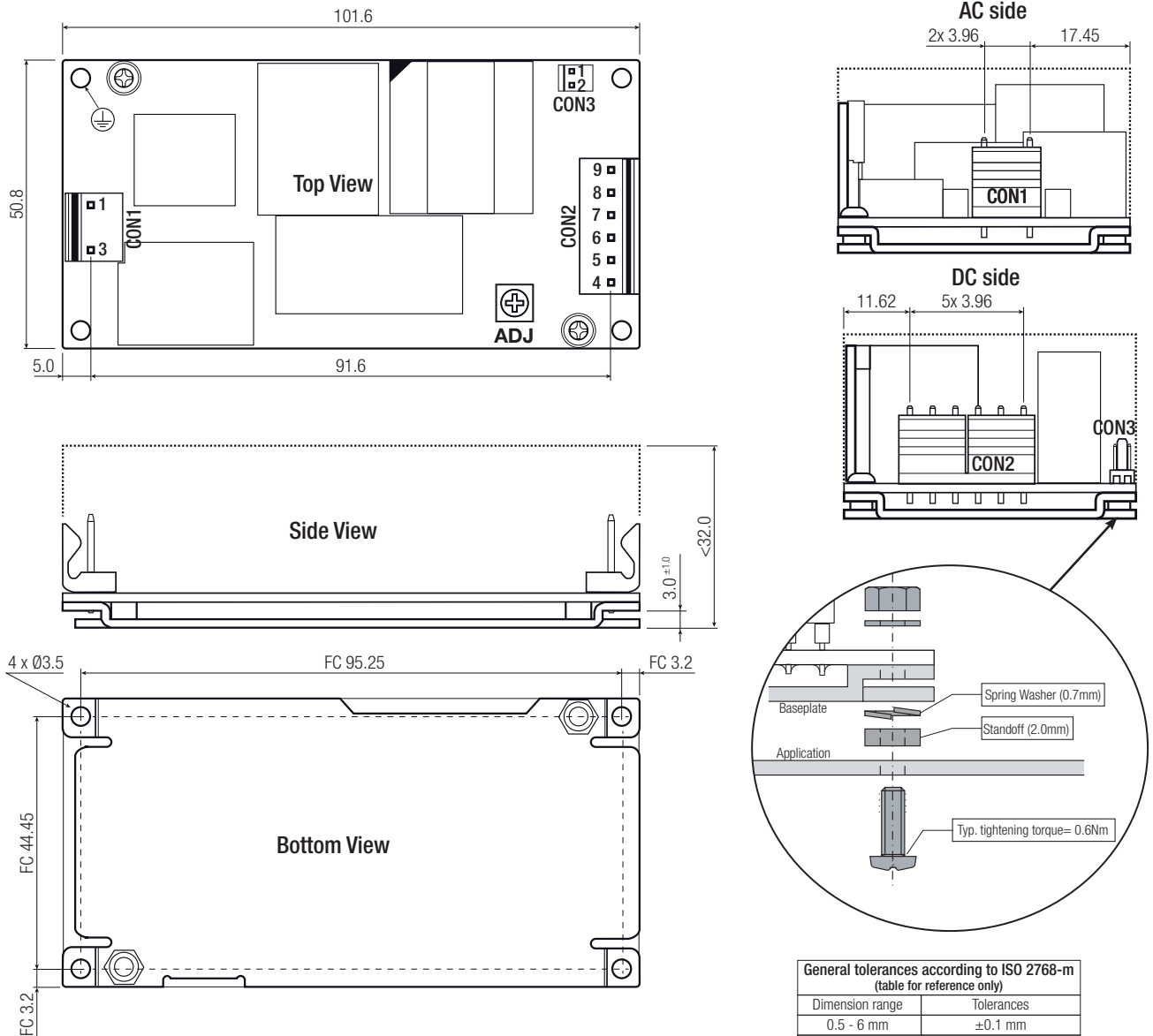

General tolerances according to ISO 2768-m (table for reference only)	
Dimension range	Tolerances
0.5 - 6 mm	±0.1 mm
6 - 30 mm	±0.2 mm
30 - 120 mm	±0.3 mm
120 - 400 mm	±0.5 mm

Compatible Connector (valid for open frame and enclosed version)

AC Input (CON1)			DC Output Connector (CON2)			FAN Connector (CON3)		
#	Function	Connector	#	Function	Connector	#	Function	Connector
1	AC/N	Molex 09-50-3031	7,8,9	+Vout	Molex 09-50-1061	1	-FAN	Molex 22-01-1022
3	AC/L	or similar	4,5,6	-Vout	or similar	2	+FAN	or similar

Maximum tightening torque for mounting without standoffs: 0.3Nm
FC= fixing centers

continued on next page

Specifications (measured @ Ta= 25°C, rated input, rated load unless otherwise stated)

Dimension Drawing Enclosed Version (mm)

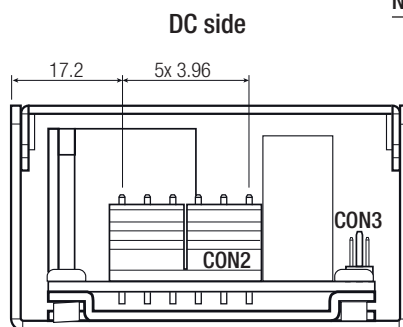
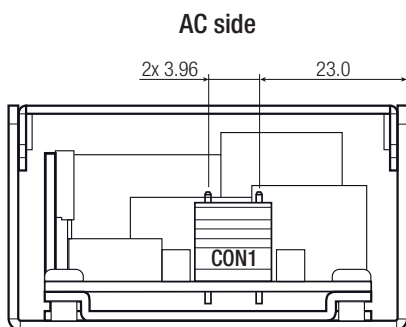
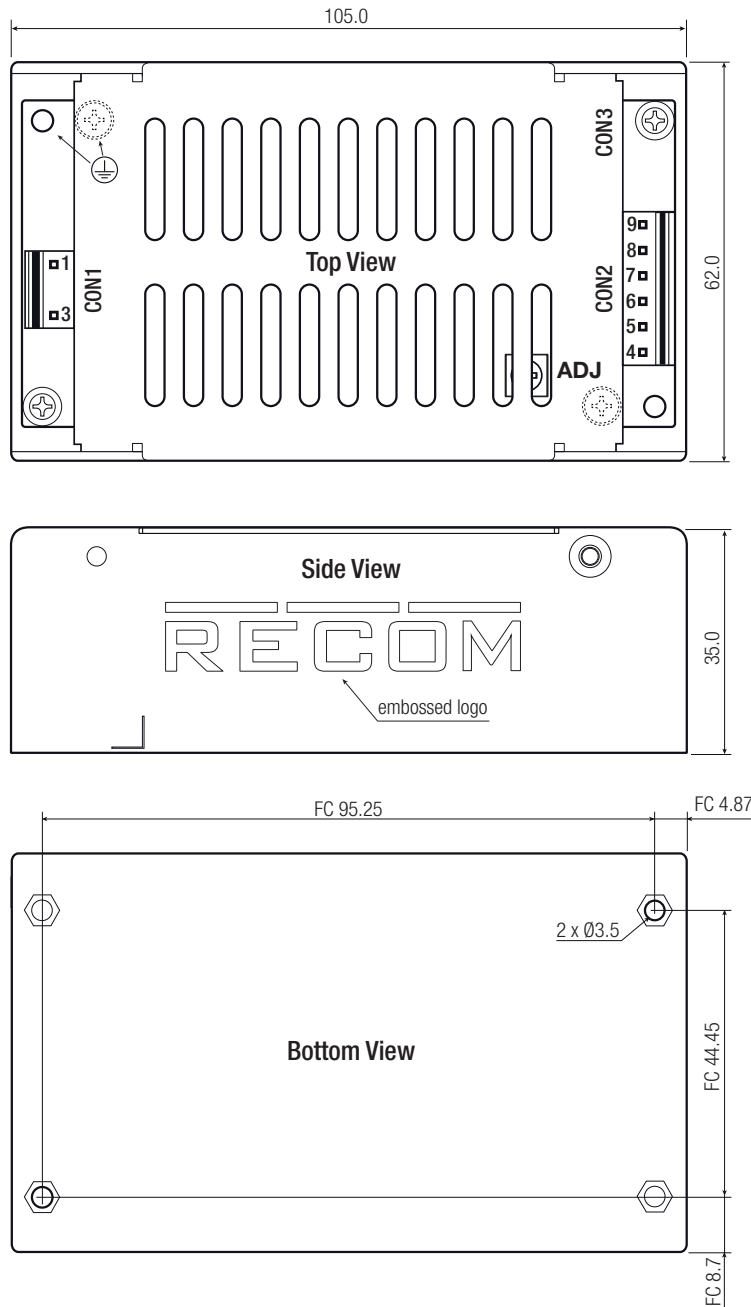

Notes:

Note13: Please remove cover, to use trim function

Maximum tightening torque for mounting: 0.6Nm
FC= fixing centers

General tolerances according to ISO 2768-m (table for reference only)	
Dimension range	Tolerances
0.5 - 6 mm	±0.1 mm
6 - 30 mm	±0.2 mm
30 - 120 mm	±0.3 mm
120 - 400 mm	±0.5 mm

Specifications (measured @ Ta= 25°C, rated input, rated load unless otherwise stated)

INSTALLATION AND APPLICATION

Mounting

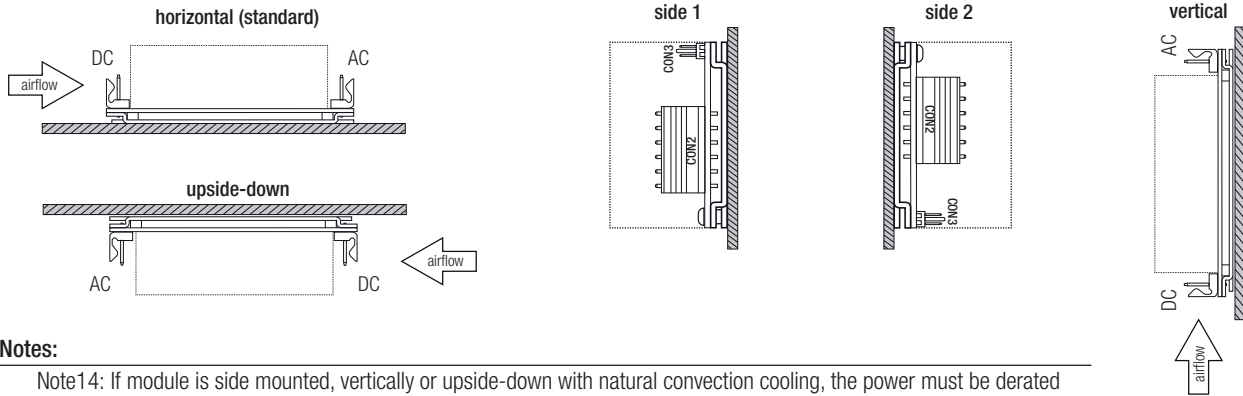

Notes:

Note14: If module is side mounted, vertically or upside-down with natural convection cooling, the power must be derated down to 85% for the RACM230-12SG, for the other models 90%.
For convection cooling, ensure sufficient distance to adjacent components!
Device should be fan cooled from DC side.

Block Diagram

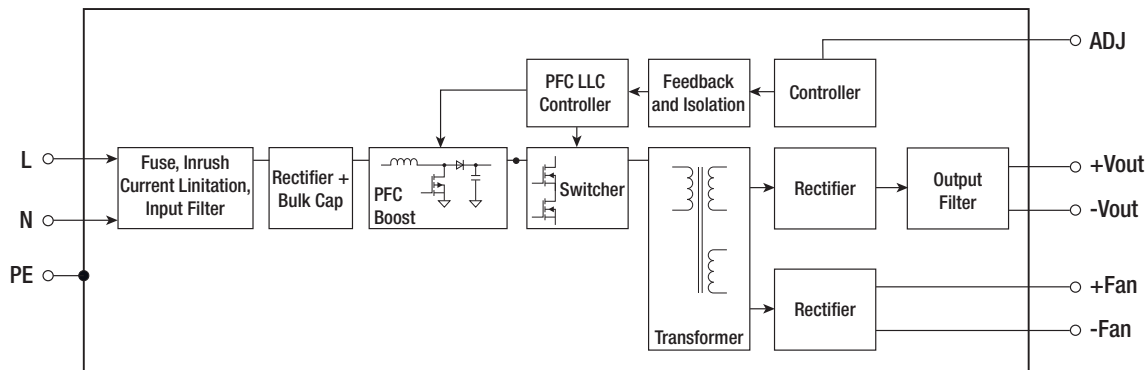

PACKAGING INFORMATION

Parameter	Type	Value
Packaging Dimension (LxWxH)	cardboard box	128.0 x 71.0 x 44.0mm
Packaging Quantity		1pcs
Storage Temperature Range		-55°C to +100°C
Storage Humidity	non-condensing	5% - 90% RH max.

The product information and specifications may be subject to changes even without prior written notice. The product has been designed for various applications; its suitability lies in the responsibility of each customer. The products are not authorized for use in safety-critical applications without RECOM's explicit written consent. A safety-critical application is an application where a failure may reasonably be expected to endanger or cause loss of life, inflict bodily harm or damage property. The applicant shall indemnify and hold harmless RECOM, its affiliated companies and its representatives against any damage claims in connection with the unauthorized use of RECOM products in such safety-critical applications.

Mouser Electronics

Authorized Distributor

Click to View Pricing, Inventory, Delivery & Lifecycle Information:

[RECOM:](#)

[RACM230-12SG](#) [RACM230-36SG](#) [RACM230-48SG](#) [RACM230-24SG](#) [RACM230-36SG/ENC](#) [RACM230-48SG/ENC](#)
[RACM230-54SG](#) [RACM230-54SG/ENC](#) [RACM230-12SG/ENC](#) [RACM230-24SG/ENC](#)