

# Variable, Audio and Telecommunication Transformers



## VARIABLE TRANSFORMERS AC VOLTAGE CONTROLS

Open models have an adjustable shaft design on most manually operated models that permits back-of-panel or bench mounting. Cased models are available in "C" styles enclose only the coil, while "CT" models provide protective housing for both coil and terminal board. Portable cord and plug models are cased plug-in models that have a ventilated steel case, line cord, receptacle, illuminated on/off switch and fuse.



LR18948 RoHS Compliant

For quantities greater than listed, call for quote.

MOUSER STOCK NO.	Staco Part No.	Fig.	Input		Output		Net Wt. Lbs.	Dimensions: in.			Price Each			
			Volts	Hertz	KVA	Amps		A	B	C	1	2	5	10
5874-171	171	A	120	50/60	0.21	1.75	2.00	1.88	3.28	2.93	107.11	103.18	100.60	98.84
5874-201	201	A	120	50/60	0.24	2.00	2.00	1.88	3.28	2.93	107.10	101.73	94.81	92.71
5874-221B	221-B	A	120	50/60	0.30	2.50	2.50	2.12	3.28	2.93	114.54	108.89	105.19	101.65
5874-252	252	A	240	50/60	0.19	0.80	2.50	2.12	3.28	2.93	180.31	172.60	166.64	159.79
5874-291	291	A	120	50/60	0.36	3.00	2.50	2.31	3.28	2.93	152.15	148.24	144.15	133.71
5874-501C	501C	B	120	50/60	0.60	5.00	5.25	3.00	3.75	4.38	170.36	158.09	152.63	149.08
5874-1010B	1010B	C	120	50/60	1.20	10.00	10.25	4.16	4.62	5.57	226.70	215.56	200.88	189.41
5874-3PN1010B	3PN1010B	D	120	50/60	1.40	10.00	10.25	6.96	4.62	5.50	338.87	330.51	323.95	300.27

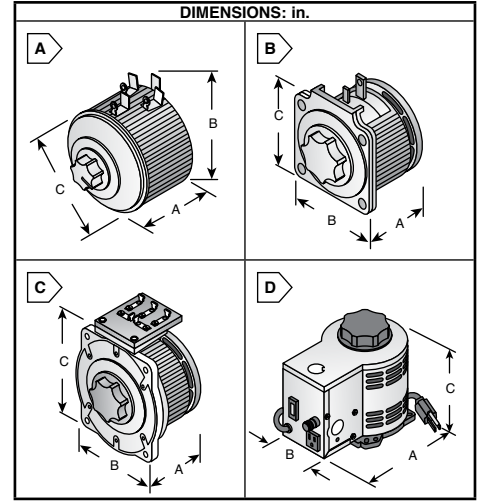

## TAMURA ULTRA WIDEBAND AUDIO TRANSFORMERS

- Frequency Range: 300Hz - 100kHz
- HiPot = 500Vrms (Pri:Sec)

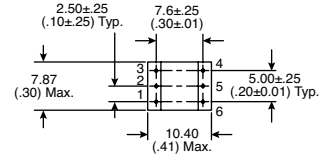
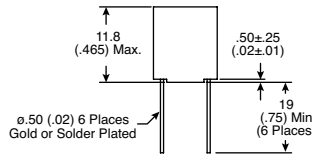
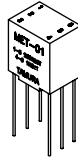

For quantities greater than listed, call for quote.

MOUSER STOCK NO.	Tamura Part No.	Impedance		Turns Ratio (Pri: Sec)	Max. Unbalanced Current (mA)	Max. Pwr. Level (mW)	Freq. Response (dB)	DCR		Price Each	
		Pri. $\Omega$	Sec. $\Omega$					Pri. $\Omega$	Sec. $\Omega$	1	10
838-MET-01	MET-01	200K CT	1K CT	14.1CT:1CT	0.0	10	$\pm 2$	5300	120	14.00	11.40
838-MET-09	MET-09	10K CT	10K CT	1CT:1CT	1.0	40	$\pm 2$	1000	1300	15.33	12.26
838-MET-11	MET-11	10K CT	2K CT	2.23CT:1CT	1.0	40	$\pm 2$	1000	300	13.35	10.68
838-MET-17	MET-17	10K CT	500 CT	4.47CT:1CT	1.0	40	$\pm 2$	1000	80	14.27	11.41
838-MET-23	MET-23	1.6K CT	3.2	22.4CT:1	2.5	65	$\pm 3$	186	0.8	12.56	10.08
838-MET-24	MET-24	1.5K CT	600	1.58CT:1	3.0	50	$\pm 2$	160	95	13.31	10.63
838-MET-28	MET-28	1K	50	4.47:1	3.0	50	$\pm 2$	110	8	10.65	8.54
838-MET-31	MET-31	600 CT	600 CT	1CT:1CT	3.0	50	$\pm 2$	70	95	12.60	10.10
838-MET-32	MET-32	600	150/150	2:1:1	3.0	50	$\pm 2$	70	95	12.53	10.02
838-MET-35	MET-35	600 CT	8	8.66CT:1	4.5	50	$\pm 2$	60	1.5	11.90	9.53
838-MET-39	MET-39	500	50	3.16:1	3.0	50	$\pm 2$	55	8	10.84	8.58
838-MET-42	MET-42	150	12	3.54:1	10.0	50	$\pm 2$	20	2.5	11.85	9.48
838-MET-46	MET-46	600	600	1:1	3.0	50	$\pm 2$	72	93	11.23	9.04
838-MET-60	MET-60	135	135 CT	1:1CT	10.0	50	$\pm 2$	10	10	12.36	9.87

## TAMURA TELECOMMUNICATION DRY COUPLING TRANSFORMER

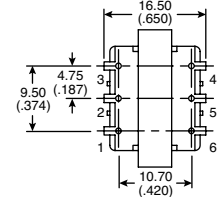
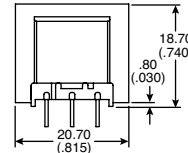
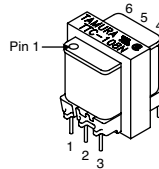

For quantities greater than listed, call for quote.

MOUSER STOCK NO.	Tamura Part No.	Impedance Pri. Sec. $\Omega$	Operating Level	Insertion Loss (dB Max.)	Total Harmonic Distortion (Max.)	Price Each			
						1	10	20	50
838-TTC-108N	TTC-108N	600:600	-45dBm to +7dBm	1.4	0.5%	7.80	6.53	5.84	5.20

## TAMURA MINIATURE ENCAPSULATED TELECOMMUNICATION V.32 MODEM TRANSFORMER

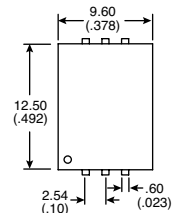
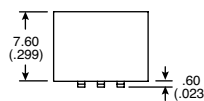
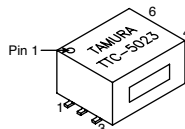

For quantities greater than listed, call for quote.

MOUSER STOCK NO.	Tamura Part No.	Impedance Pri. Sec. $\Omega$	DC Unbalance (mA)	Insertion Loss (dB Max.)	Total Harmonic Distortion (Max.)	Price Each			
						1	10	20	50
838-TTC-5023	TTC-5023	600:600	0	2	-79	4.45	3.72	3.31	2.95